

This annex to the EASA TCDS IM.A.110 was created to publish selected special conditions / deviations / equivalent safety findings that are part of the applicable certification basis:

Table of Contents:

Certification Review Items:

B-01 SC & IM: Stalling and scheduled operating speeds	3
B-02 SC: Motion and Effect of Cockpit Control	9
B-04 SC &IM: Static Directional, Lateral and Longitudinal Stability and Low energy awareness ..10	
B-05 SC: Flight envelope protection.....	13
B-06 SC: Normal load factor limiting system.....	15
B-10 SC: Human factor evaluation of novel features in the flight deck	16
B-15 SC: Soft Go Around mode	17
C-01 SC & IM: Crashworthiness of Large Aircraft Structures.....	19
C-02 SC: Discrete Gust	21
C-03 SC & IM : Loading conditions for multi-leg landing gear.....	22
C-04 SC: Undercarriage lateral turning loads	36
C-05 SC: Jacking by Landing Gear.....	37
C-06 SC: Dynamic Braking	38
C-11 SC: Interaction of Systems and Structure.....	39
C-12 ESF & IM: Vibration, Buffet and Aeroelastic Stability Requirements.....	44
C-13 SC & IM: Design Manoeuvre requirement	58
C-14 ESF & IM: Proof of structure.....	60
C-15 SC & IM: Design Dive Speed V_d	65
C-16 SC: Limit Pilot Forces.....	69
C-19 ESF: Checked Pitching Manoeuvre loads	70
C-20 ESF & IM: Engine failure loads.....	73
C-21 ESF & IM: Continuous turbulence loads	79
CCD-01 SC: Operational Suitability Data (OSD) - Cabin Crew Data (CCD).....	98
D-03 SC: Emergency exit arrangement - outside viewing.....	101
D-04 SC: Crew Rest Compartments	102
D-06 SC &IM: Use of the stairs between decks	109
D-07 SC & IM: Fire detection and protection in passenger cabin	111
D-12 SC & IM: Design for security	114
D-13 SC: Fire protection of thermal and acoustic insulation material.....	117
D-15 SC & IM: Brakes and Braking System	118
D-17 ESF & IM: Fuselage Doors.....	143
D-19 ESF &IM: Casting factors.....	158
D-20 SC & IM: Towbarless towing	166
D-21 ESF: Allowable Carbon Dioxide concentration in aeroplane cabins & Cabin Ozone concentration	169
D-24 ESF: Packs off operation.....	171
D-28 SC & IM: Harmonised 671/672	173
D-31 SC: High altitude operation.....	178
D-33 SC: Extendable Length Escape Slide.....	181
D-39 SC: Incorporation of Inertia Locking Device in Dynamic Seats	182
D-41 SC: Installation of suite type seating.....	184
D-42 SC: Type C Passenger Exits.....	190
D-43 SC: Application of heat release and smoke density requirements to seat materials	191
D-45 SC: Installation of Trolley Stowage/ Lift Systems with Proximity to Upper Deck Staircase	193

D-46 SC: Installation of Personal Electronic Device charging stowage in galley or cabin interior	194
D-47 SC & IM: Installation of Inflatable Seat Belts	195
D-48 ESF: Belly Fairing thermal/acoustic Insulation Materials	198
D-49 ESF: Improved flammability standards for Lower Deck Crew	200
D-50 ESF: Composite Pressure Bulkhead Thermal / acoustic Insulation Materials.....	204
D-52 SC & IM: Installation of structure mounted airbag	206
D-55 SC & IM: Shower Installation.....	210
D-56 ESF: Shower Installation.....	212
D-57 SC / IM / MOC: Installation of high wall suite type seating	214
E-02 SC &IM: Fuel Tank Safety.....	221
E-04 SC &IM: Thrust reverser system.....	228
E-05 SC &IM: Sustained Engine Imbalance.....	243
E-06 ESF & IM: Falling and blowing snow.....	254
E-09 ESF & IM: Fuel Tank crashworthiness	256
E-10 ESF: Fuel tank access covers.....	259
E-11 ESF: Rolls-Royce Trent turbine overheat detection.....	262
E-12 ESF: GP7200 Fan zone as a non fire zone	263
E-15 ESF: Warning means for Engine Fuel Filters.....	265
E-16 ESF: Thrust reverser testing	267
E-17 ESF: Oil temperature indication	269
E-19 ESF: Engine fuel filter location	271
E-20 ESF: Fire Extinguishing Agent Concentration.....	276
F-01 SC & IM: JAR 25.1301 and 1309 Compliance - Design assurance and safety assessment processes.....	278
F-02 SC: Slide/raft portability.....	282
F-11 ESF: Pneumatic Systems	283
F-12 SC: HIRF protection	285
F-15 ESF & IM: Hydraulic Systems	289
F-23 ESF: Landing light switch	297
F-26 SC & IM: Flight Recorders, Data Link recording	298
F-29 ESF: New harmonised JAR 25.1329	301
F-38 ESF: Overpressure Relief valves and Outflow valves.....	303
F-48 ESF: Use of Computer Simulation and similarity approach for high energy rotor containment demonstration	305
F-52 SC: Lithium-Ion Batteries Installations	306
F-53 ESF: Supplemental cooling system - Impeller pump containment.....	308
G-06 SC: Ferrying one engine unserviceable.....	310
H-01 SC: Enhanced Airworthiness Programme for Aeroplane Systems – Instructions for Continued Airworthiness (ICA) on Electrical Wiring Interconnection Systems (EWIS)	314
J-02 ESF & IM: APU installation requirements	316
K-06 ESF: Localizer Excessive Deviation Alerts	333
K-07 ESF: Limit Risk (NPA AWO 14)	335
ACRONYMS AND ABBREVIATIONS	337

SPECIAL CONDITION and IM	B-01 SC & IM: Stalling and scheduled operating speeds
APPLICABILITY:	A 380
REQUIREMENTS:	JAR 25.21, 25.103, 25.143, 25.145, 25.201, 25.203, 25.207, 25.1323
ADVISORY MATERIAL:	N/A

BACKGROUND

The A380 is equipped with a low speed protection system providing a protection against stall that cannot be overridden by the pilot.

The requirements of JAR 25 Change 15 must therefore be adapted to consider this stall protection function. A special condition is needed.

The following Special Condition, also existing on Airbus SA and LR family, allow adapt JAR 25 requirements to technology used on Airbus aircraft.

SPECIAL CONDITION

1. Definitions

This Special Condition addresses novel features of the A380 and uses terminology that does not appear in JAR 25.

The following definitions shall apply:

- High incidence protection system: A system that operates directly and automatically on the aeroplane's flying controls to limit the maximum angle of attack that can be attained to a value below that at which an aerodynamic stall would occur.
- Alpha-floor system: A system that automatically increases thrust on the operating engines when angle of attack increases through a particular value.
- Alpha-limit: The maximum angle of attack at which the aeroplane stabilises with the high incidence protection system operating and the longitudinal control held on its aft stop.
- V_{min}: The minimum steady flight speed in the aeroplane configuration under consideration with the high incidence protection system operating. See section 3 of this Special Condition.
- V_{min1g}: V_{min} corrected to 1g conditions. See section 3 of this Special Condition. It is the minimum calibrated airspeed at which the aeroplane can develop a lift force normal to the flight path and equal to its weight when at an angle of attack not greater than that determined for V_{min}.

2. Capability and Reliability of the High Incidence Protection System.

Those paragraphs of JAR 25 quoted in reference may be amended in accordance with this Special Condition provided that acceptable capability and reliability of the high incidence protection system can be established by flight test, simulation, and analysis as appropriate. The capability and reliability required are as follows:

- 1- It shall not be possible during pilot induced manoeuvres to encounter a stall and handling characteristics shall be acceptable, as required by section 5 of this Special Condition.
- 2- The aeroplane shall be protected against stalling due to the effects of windshears and gusts at low speeds as required by section 6 of this Special Condition.
- 3- The ability of the high incidence protection system to accommodate any reduction in stalling incidence resulting from residual ice must be verified.
- 4- The reliability of the system and the effects of failures must be acceptable in accordance with JAR 25.1309.

3 - Minimum Steady Flight Speed and Reference Stall Speed

Delete existing JAR 25.103 and replace as follows:

JAR 25.103 : Minimum steady flight speed and Reference stall speed

- (a) The minimum steady flight speed, V_{min} , is the final stabilised calibrated airspeed obtained when the aeroplane is decelerated until the longitudinal control is on its stop in such a way that the entry rate does not exceed 1 knot per second.
- (b) The minimum steady flight speed, V_{min} , must be determined with :
- (1) The high incidence protection system operating normally.
 - (2) Idle thrust and alpha-floor system inhibited;
 - (3) All combinations of flaps setting and landing gear position for which V_{min} is required to be determined;
 - (4) The weight used when V_{sr} is being used as a factor to determine compliance with a required performance standard;
 - (5) The most unfavourable centre of gravity allowable; and
 - (6) The aeroplane trimmed for straight flight at a speed achievable by the automatic trim system.
- (c) The one-g minimum steady flight speed, V_{min1g} , is the minimum calibrated airspeed at which the aeroplane can develop a lift force (normal to the flight path) equal to its weight, whilst at an angle of attack not greater than that at which the minimum steady flight speed of subparagraph (a) was determined.
- (d) The reference stall speed, V_{sr} , is a calibrated airspeed defined by the applicant. V_{sr} may not be less than a 1-g stall speed. V_{SR} is expressed as:

$$V_{SR} \geq \frac{V_{CL_{MAX}}}{\sqrt{n_{ZW}}}$$

Where:

- $V_{CL_{MAX}}$ = Calibrated airspeed obtained when the load factor corrected lift coefficient ($\frac{n_{ZW} * W}{qS}$) is first a maximum during the manoeuvre prescribed in sub-paragraph (f) of this paragraph.
- n_{ZW} = Load factor normal to the flight path at $V_{CL_{MAX}}$
- W = Airplane gross weight;
- S = Aerodynamic reference wing area; and
- q = Dynamic pressure.

- (e) $V_{CL_{MAX}}$ is determined with :
- (1) Engines idling, or, if that resultant thrust causes an appreciable decrease in stall speed, not more than zero thrust at the stall speed;
 - (2) The aeroplane in other respects (such as flaps and landing gear) in the condition existing in the test or performance standard in which V_{sr} is being used;
 - (3) The weight used when V_{sr} is being used as a factor to determine compliance with a required performance standard;
 - (4) The centre of gravity position that results in the highest value of reference stall speed;
 - (5) The aeroplane trimmed for straight flight at a speed achievable by the automatic trim system, but not less than $1.13 V_{sr}$ and not greater than $1.3 V_{sr}$;
 - (6) Alpha-floor system inhibited; and
 - (7) The High Incidence Protection System adjusted, at the option of the applicant, to allow higher incidence than is possible with the normal production system.
- (f) Starting from the stabilised trim condition, apply the longitudinal control to decelerate the aeroplane so that the speed reduction does not exceed one knot per second.

4 - Stall Warning

4.1 Normal operation

If the conditions of paragraph 2 are satisfied, equivalent safety to the intent of JAR 25.207, Stall Warning, shall be considered to have been met without provision of an additional, unique warning device.

4.2 High Incidence Protection System Failure

Following failures of the high incidence protection system, not shown to be extremely improbable, such that the capability of the system no longer satisfies items 1, 2 and 3 of paragraph 2, stall warning must be provided in accordance with JAR 25.207(a), (b) and (f).

5 - Handling Characteristics at High Incidence

5.1 High Incidence Handling Demonstrations

Delete existing JAR 25.201 and replace as follows:

JAR 25.201 : High incidence handling demonstration

- (a) Manoeuvres to the limit of the longitudinal control, in the nose up sense, must be demonstrated in straight flight and in 30° banked turns with:
 - (1) The high incidence protection system operating normally.
 - (2) Initial power conditions of :
 - I: Power off
 - II: The power necessary to maintain level flight at 1.5 V_{sr1} , where V_{sr1} is the reference stall speed with flaps in approach position, the landing gear retracted and maximum landing weight.
 - (3) Alpha-floor system operating normally unless more severe conditions are achieved with inhibited alpha floor.
 - (4) Flaps, landing gear and deceleration devices in any likely combination of positions.
 - (5) Representative weights within the range for which certification is requested; and
 - (6) The aeroplane trimmed for straight flight at a speed achievable by the automatic trim system.
- (b) The following procedures must be used to show compliance with JAR 25.203, as amended by this special condition:
 - (1) Starting at a speed sufficiently above the minimum steady flight speed to ensure that a steady rate of speed reduction can be established, apply the longitudinal control so that the speed reduction does not exceed one knot per second until the control reaches the stop
 - (2) The longitudinal control must be maintained at the stop until the aeroplane has reached a stabilised flight condition and must then be recovered by normal recovery techniques.
 - (3) The requirements for turning flight manoeuvre demonstrations must also be met with accelerated rates of entry to the incidence limit, up to the maximum rate achievable.

5.2 Characteristics in High Incidence Manoeuvres

Delete existing JAR 25.203 and the associated ACJ. Replace as follows:

JAR 25.203: Characteristics in High Incidence Manoeuvres.

- (a) Throughout manoeuvres with a rate of deceleration of not more than 1 knot per second, both in straight flight and in 30° banked turns, the aeroplane's characteristics shall be as follows:
 - (1) There shall not be any abnormal nose-up pitching.
 - (2) There shall not be any uncommanded nose-down pitching, which would be indicative of stall. However reasonable attitude changes associated with stabilising the incidence at Alpha limit as the longitudinal control reaches the stop would be acceptable.
 - (3) There shall not be any uncommanded lateral or directional motion and the pilot must retain good lateral and directional control, by conventional use of the controls, throughout the manoeuvre.
 - (4) The aeroplane must not exhibit buffeting of a magnitude and severity that would act as a deterrent from completing the manoeuvre specified in JAR 25.201(a)*.

(*)As amended by this Special Condition

- (b) In manoeuvres with increased rates of deceleration some degradation of characteristics is acceptable, associated with a transient excursion beyond the stabilised Alpha-limit. However the aeroplane must not exhibit dangerous characteristics or characteristics that would deter the pilot from holding the longitudinal control on the stop for a period of time appropriate to the manoeuvre.
- (c) It must always be possible to reduce incidence by conventional use of the controls.
- (d) The rate at which the aeroplane can be manoeuvred from trim speeds associated with scheduled operating speeds such as V_2 and V_{ref} up to Alpha-limit shall not be unduly damped or be significantly slower than can be achieved on conventionally controlled transport aeroplanes.

6 - Atmospheric Disturbances

Operation of the high incidence protection system must not adversely affect aircraft control during expected levels of atmospheric disturbances, nor impede the application of recovery procedures in case of windshear.

7 - Alpha floor

The Alpha-floor setting must be such that the aircraft can be flown at normal landing operational speeds and manoeuvred up to bank angles consistent with the flight phase without triggering Alpha-floor. In addition there must be no alpha-floor triggering unless appropriate when the aircraft is flown in usual operational manoeuvres and in turbulence.

8 – Proof of compliance

Add the following paragraph 25.21 (b):

- (b) The flying qualities will be evaluated at the most unfavourable CG position.

9 – Change JAR 25.145 (a), JAR 25.145 (b) (6) and JAR 25.1323 (c) (2) as follows:

JAR 25.145 (a)	V_{min} in lieu of “stall identification”
JAR 25.145 (b) (6)	V_{min} in lieu of V_{sw}
JAR 25.1323 (c) (2)	“From 1.23 V_{sr} to V_{min} ” in lieu of “1.23 V_{sr} to stall warning speed” and “speeds below V_{min} ” in lieu of “speeds below stall warning”

INTERPRETATIVE MATERIAL

1. Introduction

This Interpretative Material expands various aspects of Special Condition B-1 and replaces the JAR 25 ACJ's that are no longer applicable due to the amendments introduced by Special Condition B-1.

2. Alpha protection tolerances

Flight testing may be made with nominal AOA protection system settings unless tolerances are such as to produce significant changes in performance determination and handling qualities, in which case the most adverse settings within the tolerance band should be used.

3. Minimum Steady Flight Speed Entry Rate

(See JAR 25.103(a) and JAR 25.203(a) as amended by paragraphs 3 and 5.2 of Special Condition B-1)

The minimum steady flight speed entry rate is defined as follows:

$$\text{Entry rate} = \frac{1.15 V_{\min 1g} - 1.05 V_{\min 1g}}{\text{Time to decelerate from } 1.15 V_{\min 1g} \text{ to } 1.05 V_{\min 1g}} \quad (\text{knot CAS/sec})$$

4. Manoeuvring Capabilities at Scheduled Operating Speeds

(See paragraph JAR 25.143 (g))

- (1) The manoeuvre capabilities specified in JAR 25.143 (g) shall be achieved at constant CAS.
- (2) The ability to sustain the specified levels of manoeuvrability in coordinated turns may be assumed where the scheduled speeds are not less than $V_2 = 1.08 V_{\min 1g}$
 V_{2+xx} , V_{FTO} and $V_{REF} = 1.16 V_{\min 1g}$
- (3) A low thrust or power setting normally will be the critical case for demonstrating the required manoeuvre capabilities. The thrust/power settings specified in paragraph JAR 25.143 (g) are the maximum values that may be used in such cases. However, if the angle of attack at which the stick stop is reached (or other relevant characteristic occurs) is reduced with increasing thrust or power, it should be ensured that the required manoeuvre capabilities are retained at all higher thrust or power settings appropriate to the flight condition.
- (4) The thrust or power setting for the all-engines operating condition at V_{2+xx} should include any value used in noise abatement procedure.

5. Stall Warning for High Incidence Protection System Failure

(See paragraph 4.2 of Special Condition B-1)

The stall warning margin should prevent inadvertent stalling in the following conditions:

- (1) power off straight stall approaches to a speed 5 per cent below the warning onset.
- (2) turning flight stall approaches at entry rate up to 3 knots per second when recovery is initiated not less than one second after the warning onset.

6. Power Setting for power-on Handling to High Incidence

(See JAR 25.201(a) (2) as amended by paragraph 5.1 of Special Condition B-1)

The power for power-on manoeuvre demonstrations to high incidence is that power necessary to maintain level flight at a speed of $1.5 V_{sr1}$ at maximum landing weight, with flaps in the approach position and landing gear retracted, where V_{sr1} is the reference stall speed in the same conditions (except power). The flap position to be used to determine this power setting is that position in which the reference stall speed does not exceed 110% of the reference stall speed with the flaps in the most extended landing position.

7. Position of Deceleration Devices During Handling to High Incidence

(See JAR 25.201 as amended by paragraph 5.1 of Special Condition B-1)

Demonstrations of manoeuvres to high incidence for compliance with JAR 25.201 should include demonstrations with deceleration devices deployed for all flap positions unless limitations against use of the devices with particular flap positions are imposed." Deceleration devices" include spoilers when used as air brakes, and thrust reversers when use in flight is permitted. High incidence manoeuvre demonstrations with deceleration devices deployed should normally be carried out with an initial power setting of power off, except where deployment of the deceleration devices while power is applied is likely to occur in normal operations (e.g use of extended air rakes during landing approach). Demonstrations with Alpha-floor both inhibited and operating normally should be included.

8. Characteristics During High Incidence Manoeuvres

(See JAR 25.203, as amended by paragraph 5.2 of Special Condition B-1)

- 1) The behaviour of the aeroplane includes the behaviour as affected by the normal functioning of any systems with which the aeroplane is equipped, including devices intended to alter the high incidence handling characteristics of the aeroplane.
- 2) Unless the design of the automatic flight control system of the aeroplane protects against such an event, the high incidence characteristics, when the aeroplane is manoeuvred under the control of the automatic flight control system should be investigated.
- 3) Any reduction of pitch attitude associated with stabilising the incidence at Alpha limit should be achieved smoothly, at a low pitch rate, such that it is not likely to be mistaken for natural stall identification.

9. Atmospheric Disturbances

(See paragraph 6 of Special Condition B-1)

In establishing compliance with paragraph 6 of Special Condition B-1, the high incidence protection system and Alpha-floor system shall be assumed to be operating normally.

Simulator studies and analyses may be used but will need to be validated by limited flight testing to confirm handling qualities, at critical loadings, up to the maximum incidence shown to be reached by such studies and analyses.

10. Alpha Floor

(See paragraph 7 of Special Condition B-1)

Compliance with paragraph 7 of Special Condition B-1 shall be considered as being met if alpha-floor setting provides a manoeuvring capability of 40° bank angle,

- in the landing configuration
- at $V_{ref}+5$ (recommended final approach speed)
- with the thrust for wings level unaccelerated -3° glide path, without alpha-floor triggering.

– END –

SPECIAL CONDITION:	B-02 SC: Motion and Effect of Cockpit Control
APPLICABILITY:	A380
REQUIREMENTS:	JAR 25.143, JAR 25.777
ADVISORY MATERIAL:	N/A

BACKGROUND

The A380 is equipped with a side stick control system. The current requirements JAR 25.143 and JAR 25.777 must be adapted to side stick controls.

The following Special Condition, also existing on Airbus SA and LR family, allow adapt JAR 25 requirements to technology used on Airbus aircraft.

SPECIAL CONDITION

- 1) Add to paragraph JAR 25.777 (b):

Pitch and roll control force and displacement sensitivity shall be compatible, so that normal inputs on one control axis will not cause significant unintentional inputs on the other.

- 2) Introduce new paragraph JAR 25.143 (i) :

Pilot strength

In lieu of the "strength of pilots" limits shown in 25.143 (c) for pitch and roll, and in lieu of specific pitch force requirement of 25.145 (b) and 25.175 (d), it must be shown that the temporary and maximum prolonged force levels for the side stick controllers are suitable for all expected operating conditions and configurations, whether normal or non-normal.

- 3) Introduce new paragraph JAR 25.143 (j) :

Pilot control

It must be shown by flight tests that turbulence does not produce unsuitable pilot-in-the-loop control problems when considering precision path control/tasks.

- 4) Introduce new paragraph JAR 25.143 (k):

When a flight case exists where, without being commanded by the crew, control surfaces are coming so close to their limits that return to normal flight condition and (or) continuing of safe flight needs a specific crew action, a suitable flight control position annunciation shall be provided to the crew, unless other existing indications are found adequate or sufficient to prompt that action.

– END –

SPECIAL CONDITION and IM :	B-04 SC &IM: Static Directional, Lateral and Longitudinal Stability and Low energy awareness
APPLICABILITY:	A380
REQUIREMENTS:	JAR 25.171, JAR 25.173, JAR 25.175, JAR 25.177, SC B-1
ADVISORY MATERIAL:	IM B-1

BACKGROUND

The A380, like A320 and A330/A340, is equipped with an electronic flight control system.

1) Lateral-directional Stability

The A380 has a flight control design feature within the normal operational envelope in which side stick deflection in the roll axis commands roll rate. As a result, the stick force in the roll axis will be zero (neutral stability) during the straight, steady sideslip flight manoeuvre of JAR 25.177(c) and will not be “substantially proportional to the angle of sideslip” as required by the rule.

2) Longitudinal Stability

The A380 longitudinal control laws provide neutral stability within the normal flight envelope. Therefore, the aircraft design does not literally comply with the static longitudinal stability requirements of JAR 25.171, 25.173, and 25.175.

3) Low energy awareness

Static longitudinal stability is a factor in providing awareness of an aircraft's energy state (speed and thrust). Even though protection systems secure A380 against stall, energy awareness is essential for medium-term flight path control, which is a key safety criterion at low altitude. Therefore, when close to the ground, all relevant factors must be considered to ensure that the pilot is provided with adequate energy cues.

A special condition is necessary to address static lateral-directional and longitudinal stability and low energy awareness.

The following Special Condition, also existing on Airbus SA and LR family, allows to adapt JAR 25 requirements to technology used on Airbus aircraft.

SPECIAL CONDITION

Replace JAR 25.171 by the following:

"The aircraft must be shown to have suitable lateral, directional and longitudinal stability in any condition normally encountered in service, including the effects of atmospheric disturbances.

The aircraft, fitted with flight control laws presenting neutral static longitudinal stability significantly below the normal operating speeds, must provide adequate awareness to the pilot of a low energy state. "

Remove JAR 25.173

Remove JAR 25.175

Replace JAR 25.177 by the following:

- (a) The static directional stability (as shown by the tendency to recover from a skid with the rudder free) must be positive for any landing gear and flap position and symmetrical power condition, at speeds from $1.13 V_{SR}$, up to V_{FE} , V_{LE} , or V_{FC}/M_{FC} (as appropriate).
- (b) Reserved
- (c) In straight, steady sideslips (unaccelerated forward slips) the rudder control movements and forces must be substantially proportional to the angle of sideslip, and the factor of proportionality must be between limits found necessary for safe operation throughout the range of sideslip angles appropriate to the operation of the aeroplane. At greater angles, up to the angles at which full rudder control is used or a rudder pedal force of 180 pounds (81,72 kg) is obtained, the rudder pedal forces may not reverse and increased rudder deflection must produce increased angles of sideslip. Unless the aeroplane has a suitable sideslip indication, there must be enough bank and lateral control deflection and force accompanying sides-lipping to clearly indicate any departure from steady unyawed flight.

INTERPRETATIVE MATERIAL

I. Lateral-directional stability

Positive static directional stability is defined as the tendency to recover from a skid with the rudder free.

Positive static lateral stability is defined as the tendency to raise the low wing in a sideslip with the aileron controls free. These control criteria are intended to accomplish the following:

- 1) Provide additional cues of inadvertent sideslips and skids through control force changes.
- 2) Ensure that short periods of unattended operation do not result in any significant changes in yaw or bank angle.
- 3) Provide predictable roll and yaw response.
- 4) Provide acceptable level of pilot attention (workload) to attain and maintain a co-ordinated turn.

A suitable lateral-directional stability must allow achieving the same goal. In the absence of positive lateral stability, the curve of lateral surface deflection against sideslip angle should be in a conventional sense and reasonably in harmony with rudder deflection during the sideslip.

II. Longitudinal stability and low energy awareness

1) General

The aeroplane's static longitudinal stability and energy awareness characteristics shall be evaluated by flight and simulator tests. Control laws that result in neutral static stability throughout most of the operational flight envelope may be accepted in principle subject to :

- adequate speed control without excessive pilot workload
- suitable longitudinal behaviour in turbulence
- acceptable high and low speed protection
- provision of adequate cues to the pilot of significant speed excursions beyond V_{MO}/M_{MO} , and of low energy situations.

2) Longitudinal stability

- (a) Accurate speed control shall be achievable without excessive pilot workload in the full range of operating speeds including low speeds (scheduled speeds at take-off and landing with or without engine failed) and high speeds for each configuration including V_{MO}/M_{MO} .
- (b) Since conventional relationships between stick forces and control surface displacements do not apply to a manoeuvre demand control system, longitudinal static stability

characteristics shall be determined on the basis of the aeroplane's response to disturbances rather than on the basis of stick force versus speed gradients.

- (c) Outside the normal flight envelope adequate high or low speed cues may be provided by a strong positive stability gradient. A force gradient of 1 lb for each 6 knots, applied through the side-stick shall be considered as providing this strong stability.

3) Low energy awareness

Although stability cues and protection systems may be adequate at high altitude, past experience has shown that additional attention is required at low altitude. Adequate cues shall be available to the pilot to ensure that the aircraft retains sufficient energy to recover from low power and/or low speed situations when close to the ground.

Such low energy cues may be provided by an appropriate warning with the following characteristics:

- a. it should be unique, unambiguous, and unmistakable.
- b. it should be active at appropriate altitudes and in appropriate configurations (ie at low altitude, in the approach and landing configurations).
- c. it should be sufficiently timely to allow recovery to a stabilized flight condition inside the normal flight envelope while maintaining the desired flight path and without entering the flight controls angle-of-attack protection mode.
- d. it should not be triggered during normal operation, including operation in moderate turbulence for recommended manoeuvres at recommended speeds.
- e. it should not be cancellable by the pilot other than by achieving a higher energy state.
- f. there should be an adequate hierarchy among the various warnings so that the pilot is not confused and led to take inappropriate recovery action if multiple warnings occur.

Global energy awareness and non-nuisance of low energy cues shall be evaluated by simulator and flight tests in the whole take-off and landing altitude range for which certification is requested, in all relevant combinations of weight, center of gravity position, configuration, airbrakes position, and available thrust, including reduced and derated take-off thrust operations and engine failure cases. A sufficient number of tests shall be conducted, allowing the level of energy awareness and the effects of energy management errors to be assessed.

– END –

SPECIAL CONDITION:	B-05 SC: Flight envelope protection
APPLICABILITY:	A380
REQUIREMENTS:	JAR 25.143
ADVISORY MATERIAL:	N/A

BACKGROUND

As the A320 and the A330/340, the A380 has flight envelope protections (high and low speed, Angle of Attack) implemented in the Electrical Flight Control System (EFCS). A special condition has been developed in the frame of A320 and A330/A340 certification to address these unusual features. As JAR 25 has not yet been amended to take into account EFCS and flight envelope protections, it is proposed to apply the same special condition to the A380, in accordance with JAR 21.16(a)(1).

The following Special Condition, also existing on Airbus SA and LR family, allow adapt JAR 25 requirements to technology used on Airbus aircraft.

SPECIAL CONDITION

Add a new paragraph JAR 25.143 (g) :

Normal operation :

1. Onset characteristic of each envelope protection feature must be smooth, appropriate to the phase of flight and type of manoeuvre and not in conflict with the ability of the pilot to satisfactorily change airplane flight path, or attitude as needed.
2. Limit values of protected flight parameters must be compatible with:
 - a) Airplane structural limits,
 - b) Required safe and controllable manoeuvring of the airplane and
 - c) Margin to critical conditions.

Unsafe flight characteristics/conditions must not result from:

- Dynamic manoeuvring,
- Airframe and system tolerances (both manufacturing and in-service), and
- Non-steady atmospheric conditions, in any appropriate combination and phase of flight, if this manoeuvring can produce a limited flight parameter beyond the nominal design limit value.

Note : Reference may be made to FAA Advisory Circular AC 120-41 for guidance on atmospheric conditions.

3. The airplane must respond to intentional dynamic manoeuvring within a suitable range of the parameter limit. Dynamic characteristics such as damping and overshoot must also be appropriate for the flight manoeuvre and limit parameter concerned.
4. When simultaneous envelope limiting is engaged, adverse coupling or adverse priority must not result.

Failure states :

EFCS (including sensor) failures must not result in a condition where a parameter is limited to such a reduced value that safe and controllable manoeuvring is no longer available. The crew must be alerted by suitable means if any change in envelope limiting or

manoeuvrability is produced by single or multiple failures of the EFCS not shown to be extremely improbable.

– END –

SPECIAL CONDITION:	B-06 SC: Normal load factor limiting system
APPLICABILITY:	A380
REQUIREMENTS:	JAR 25.143
ADVISORY MATERIAL:	N/A

BACKGROUND

As the A320 and the A330/A340, the A380 has a normal load factor limiting feature implemented in the flight control laws. A special condition has been issued for the A320 and the A330/A340 to address this unusual feature. As JAR 25 has not been amended to reflect the use of normal load factor limiting features, the same special condition is proposed for A380, in accordance with JAR 21.16(a)(1).

The following Special Condition, also existing on Airbus SA and LR family, allow adapt JAR 25 requirements to technology used on Airbus aircraft.

SPECIAL CONDITION

Add a new paragraph JAR 25.143 (i):

In the absence of other limiting factors

1. The positive limiting load factor must not be less than:
 - a) 2.5 g for the EFCS normal state with high lift devices retracted.
 - b) 2.0 g for the EFCS normal state with the high lift devices extended.
2. The negative limiting load factor must be equal to or more negative than:
 - a) Minus 1.0 g for the EFCS normal state with high lift devices retracted.
 - b) 0 g for the EFCS normal state with high lift devices extended.

– END –

SPECIAL CONDITION:	B-10 SC: Human factor evaluation of novel features in the flight deck
APPLICABILITY:	A380
REQUIREMENTS:	25. 771(a) ; 25.771(e); 25.777(a); 25.1301(a); 25.1309; 25.1523
ADVISORY MATERIAL:	JAA INT POL 25/14

BACKGROUND

It is well recognised that Human Performance is now cited in more than 70% of aircraft accidents. It is also well established that the design of the aircraft flight deck and other systems can strongly influence the performance (strengths and weaknesses) of a crew. Therefore the design of the flight deck should be assessed to limit the risks arising from human performance considerations. This should be a priority in addressing safety standards of aircraft design.

The changes in technology will affect the interaction between the aircraft, the flight crew and the environment (ATC, airline ground base, other aircrafts) and this may impact safety.

A standard approach should be adopted to address Human Factors issues in flight deck design. This will be applied until the Human Factors Harmonisation Working Group [HWG] reports its findings regarding a permanent regulatory solution.

FAA guidance describes a process to promote early discussion and agreement between the FAA and the applicant regarding the methods by which the applicant may demonstrate compliance with human factors-related regulations during certification projects.

The JAA have published INT/POL 25/14 on 15 March 2001. This interim policy proposes a generic special condition, and guidelines for acceptable means of compliance to deal with the Human factors aspects of flight deck design when novel features are introduced.

SPECIAL CONDITION

- a) The design of the integrated Flight Deck Interface must adequately address the foreseeable performance, capability and limitation of the flight crew.
- b) More specifically, the following aspects of the flight deck interface must be assessed :
 - i) Ease of operation [including automation
 - ii) The effects of crew errors in managing the system, including the potential for error, the possible severity of the consequences, and the provision for recognition and recovery from error
 - iii) Task sharing and distribution of workload between crew members during normal and abnormal operation
 - iv) The adequacy of the feedback, including clear and unambiguous
 - presentation of information
 - representation of system condition by display of system status
 - indication of failure cases, including aircraft status
 - indication of prolonged or severe compensatory action by a system when such action could adversely affect aircraft safety

– END –

SPECIAL CONDITION:	B-15 SC: Soft Go Around mode
APPLICABILITY:	A380
REQUIREMENTS:	JAR 25.101 (g)(h), 25.119, 25.121 (d), 25.1001, 25.1301, 25.1309, 25.1587 (b)(3)(ii)
ADVISORY MATERIAL:	Part 21 GM 21A.16B, CRI B-12, CRI B-10

BACKGROUND

A380, is proposed to be equipped with a new thrust setting “Soft GoAround (Soft GA)” which is available after GA initiation. When the pilot selects TOGA during an approach, the Soft GA thrust is «armed», and becomes active when thrust levers are retarded by the pilot to the MCT/FLX position. In this case, the MCT/FLX position corresponds to Soft GA thrust actually commanded (active). Autothrust (A/THR) is engaged but not active and AP/FD modes switch to Go-around mode (SRS / GA TRK or NAV).

At Reduction Altitude (LVR CLB flashing on FMA), the pilot brings back thrust levers to CLB position and Engine Limit mode changes to “CLB” and the A/THR becomes active (to SPEED/THR CLB mode).

At any time during a Soft Go-around, Max thrust can still be commanded by pushing thrust levers to TOGA detent.

Soft Go-around setting is a function of weight, altitude and temperature designed to provide the thrust necessary to achieve 2000ft/min. When the 2000ft/min is forecasted not achievable, GA thrust is used for Soft GA.

According to JAR 25.1587 (b)(3)(ii), the climb gradient in the approach configuration must be established in the Airplane Flight Manual in Performance section:

25.1587 (b)

quote

(b) Each aeroplane Flight Manual must contain the performance information computed under the applicable provisions of this JAR-25 (including JAR 25.115, 25.123 and 25.125 for the weights, altitudes, temperatures, wind components, and runway gradients, as applicable) within the operational limits of the aeroplane, and must contain the following:

- (1) In each case, the conditions of power, configuration, and speeds, and the procedures for handling the aeroplane and any system having a significant effect on the performance information.*
- (2) VSR determined in accordance with JAR 25.103.*
- (3) The following performance information (determined by extrapolation and computed for the range of weights between the maximum landing weight and the maximum take-off weight):*
 - (i) Climb in the landing configuration.*
 - (ii) Climb in the approach configuration.*
 - (iii) Landing distance.*

unquote

AMJ 25.1581 6)d) (15) gives further guidance as follows:

quote

(15) Approach Climb Performance. For the approach climb configuration, the climb gradients (JAR 25.121(d)) and weights up to maximum take-off weight (JAR 25.1587(b)(3)) should be presented, together with associated conditions (e.g. procedures and speeds).

The effects of ice accretion on unprotected portions of the airframe and the effects of engine and wing ice protection systems should be provided.

Unquote

In the above material, it has been implicitly assumed that the all-engines-operating go-around climb gradient would be higher than or equal to the one-engine-inoperative go-around climb gradient, and that publishing the latter in the Airplane Flight Manual would therefore be sufficient.

The new “Soft GA” thrust setting, potentially leading to lower climb performance with all engines operating than with one engine inoperative, invalidates this assumption and is therefore a novel and unusual design feature as defined in Part 21.16B, which necessitates a Special Condition to be raised. Also, it is necessary to ensure that go-around climb gradient is always equal to or higher than the approach climb gradient published in the AFM.

SPECIAL CONDITION

25.1587 (b) (3) (ii) Climb in the approach configuration.

Published approach climb performance shall represent the lower of:

- a. the performance obtained with GA thrust and one engine inoperative
- b. the performance obtained with “Soft GA” thrust and all engines operating

Alternatively, when “Soft GA” thrust setting is used and resulting climb gradient with all engines operating is lower than the climb gradient that would be obtained with GA thrust and one engine inoperative, there shall be a clear and unmistakable means to alert the flight crew of this situation.

– END –

SPECIAL CONDITION and IM :	C-01 SC & IM: Crashworthiness of Large Aircraft Structures
APPLICABILITY:	A380
REQUIREMENTS:	JAR 25.561
ADVISORY MATERIAL:	N/A

BACKGROUND

The Very Large Transport Aeroplane Conference (Noordwijkerhout, The Netherlands, 13-16 October 1998) addressed the issue of crashworthiness in a very large, double deck aeroplane with the following recommendations SI-01:

“ Definition needed of a minor and/or survivable crash condition.

These conditions could be different for types of aeroplane.

For all occupants the survivability should have a minimum level, although the intrinsic level could be different for individual occupants

The dynamic behaviour of the principal structure needs to be addressed. Dynamic testing of items of mass in the cabin (galley, overhead bins, etc., but not seats) is considered not to be necessary. ”

Existing requirements (25.561(b), 25.562) specify deceleration or load levels which apply locally to occupants, or items of mass, but do not define the overall crash conditions for which the structure should provide a reasonable level of occupant survivability. The 5 fps interpretation used to define minor crash landing condition of 25.561(b) and 25.783(c) and the basic crashworthiness requirements found within JAR/FAR25 remain valid for this aeroplane but do not reflect the real crash survivability levels achieved by current large transport aircraft.

This CRI is concerned with potential degradations in survivability at conditions appropriate to the limits of survivability for a typical current large transport aircraft. The particular A380 features that lead to the need for this CRI are:

1. Extensive double deck configuration
2. Structure of greater scale than current large transport aircraft.

The objective of this CRI is to ensure that neither of these features will result in a degradation of survivability under conditions approaching the limits of survivability for a conventional large transport aircraft.

SPECIAL CONDITION

Airbus must demonstrate that the A380 provides an equivalent level of crash survivability to that demonstrated on conventional large transport aircraft (CLTA). This may be achieved by demonstrating for a typical fuselage section that, at impacts up to a vertical descent rate representing the Limit of Reasonable Survivability (LRS) for a CLTA.

1. Structural deformation will not result in infringement of the occupant’s normal living space.
2. It must be shown that the occupants will be protected from injury as a result of release of seats, overhead bins and other items of mass due to structural deformation of the supporting structure. The attachments of these items need not be designed for static emergency landing loads in excess of those defined in JAR 25.561.
3. The Dynamic Response Index (DRI) experienced by the occupants will not be more severe than that experienced on CLTAs.

The loading of the fuselage for this evaluation must be agreed with the Authority, particularly with respect to the loading of the cargo compartment and the likely effect of this on the dynamic impact characteristics of the fuselage barrel.

As an alternative to a fuselage section analysis, a complete aircraft analysis may be performed to demonstrate an equivalent level of crash survivability to CLTA. In this case, the conditions must be agreed with the JAA Structures Panel.

INTERPRETATIVE MATERIAL

Airbus studies have indicated that a V_z of 22 ft/sec represents the point at which a conventional A340 fuselage structure becomes severely disrupted. This is shown by an analytical model which demonstrates failure of the floor beams and significant lower shell failure at this speed. The value of 22 ft/sec is therefore regarded as an acceptable LRS value of V_z for the A380. This value is also regarded by the JAA Structures Panel as representing a generally applicable acceptable minimum standard for the LRS condition.

– END –

SPECIAL CONDITION:	C-02 SC: Discrete Gust
APPLICABILITY:	A380
REQUIREMENTS:	JAR 25.341(a)
ADVISORY MATERIAL:	N/A

BACKGROUND

The Very Large Transport Aeroplane Conference (Noordwijkerhout, The Netherlands, 13-16 October 1998) concluded on the subject of discrete gust requirements:

“The 350 ft limit is not considered to be adequate anymore for VLTA. This upper limit should be adapted to the specific size of the aeroplane. The discrete gust requirements are based on the assumption that the 350 ft gust length is the longest gust to be considered. This was based on the 12.5C of the Boeing 747. The assumption is not valid anymore and the maximum gust length should be adapted.”

JAR 25.341(a)(3) is not adapted for aircraft with a geometric mean chord greater than 28 ft.

The upper limit of gust gradient distance for use in the discrete gust analysis of the Airbus A380 aircraft must be at least 12.5 times the geometric mean chord.

The reference gradient distance for use in definition of gust velocity in the tuning law $(H/H_0)^{1/6}$ must remain unchanged at 350 ft.

In accordance with JAR 21.16(a)(1), the following special condition is proposed in lieu of the requirement of § 25.341(a)(3).

SPECIAL CONDITION

Replace JAR 25.341(a) (3) by:

“A sufficient number of gust gradient distances in the range 30 ft to 435 ft (12.5 times A380 Geometric Mean Chord) must be investigated to find the critical load response.”

– END –

SPECIAL CONDITION and IM :	C-03 SC & IM : Loading conditions for multi-leg landing gear
APPLICABILITY:	A380
REQUIREMENTS:	25.471, 25.473, 25.477, 25.479, 25.481, 25.489, 25.491, 25.493, 25.499, 25.503, 25.507, 25.511, 25.519, 25.723
ADVISORY MATERIAL:	N/A

BACKGROUND

Current landing and ground load requirements assume a conventionally configured landing gear comprising two main units and a nose or tail wheel. Multi-leg configurations such as found on the Airbus A380 are not addressed and a special condition is therefore appropriate.

SPECIAL CONDITION

JAR 25.473 Landing load conditions and assumptions.

(a) The landing gear and aeroplane structure must be investigated for the landing conditions specified in JAR 25.480 to JAR 25.485. For these conditions, the aeroplane is assumed to contact the ground -

- (1) In the attitudes defined in JAR 25.480 and JAR 25.483(b)
- (2) At the descent velocities defined in JAR 25.480 and JAR 25.483. The prescribed descent velocities may be modified if it is shown that the aeroplane has design features that make it impossible to develop these velocities.

(b) Aeroplane lift, not exceeding aeroplane weight, may be assumed unless the presence of systems or procedures significantly affects the lift.

(c) The method of analysis of aeroplane and landing gear loads must take into account at least the following elements:

- (1) Landing gear dynamic characteristics.
- (2) Spin-up and spring back.
- (3) Rigid body response.
- (4) Structural dynamic response of the airframe, if significant.
- (5) Each approved tyre with nominal characteristics.

(d) The landing gear dynamic characteristics must be validated by tests as defined in JAR 25.723(a).

(e) The coefficient of friction between the tyres and the ground may be established by considering the effects of skidding velocity and tyre pressure. However, this coefficient of friction need not be more than 0.8.

Delete JAR 25.477

Delete JAR 25.479

JAR 25.480 Symmetric landing load conditions.

The landing gear and airframe structure must be designed for the dynamic landing conditions of this paragraph, using the assumptions specified in JAR 25.473.

(a) The aeroplane is assumed to contact the ground -

- (1) With an airspeed corresponding to the attitudes specified in paragraphs (b) or (c) of this section, as applicable, in the following conditions:

- (i) standard sea level conditions, and
- (ii) at maximum approved altitude in a hot day temperature of 22.8°C (41°F) above standard.

The airspeed need not be greater than $1.25V_{S0}$, or less than V_{S0} , where V_{S0} = the 1-g stalling speed based on C_{NAmax} at the appropriate weight and in the landing configuration. The effects of increased ground contact speeds must be investigated to account for downwind landings for which approval is desired.

- (2) With a limit descent velocity of 3.05 m/sec (10 fps) at the design landing weight (the maximum weight for landing conditions at maximum descent velocity); and,
- (3) With a limit descent velocity of 1.83 m/sec (6 fps) at the design takeoff weight (the maximum weight for landing conditions at a reduced descent velocity).

(b) *Not applicable to A380.*

(c) For aeroplanes with nose wheels, the conditions specified in this paragraph must be investigated assuming the following attitudes:

(1) An attitude in which the nose and main wheels are assumed to contact the ground simultaneously, as shown in figure 2 of Appendix A. For this condition, airplane pitching moment is assumed to be reacted by the nose gear.

(2) An attitude corresponding to the smallest pitch attitude at which the main landing gear units reach maximum vertical compression before impact on the nose gear.

(3) An attitude corresponding to either the stalling angle or the maximum angle allowing clearance with the ground by each part of the aeroplane other than any wheel of the main landing gear units, in accordance with figure 3 of Appendix A, whichever is less.

(4) For aircraft with more than two main landing gear units or more than two wheels per main landing gear unit, any intermediate attitude that may be critical.

(d) For aeroplanes with two main landing gear units, landing is considered on a level runway. For aeroplanes with more than two main landing gear units, landing must be considered on a level runway and, as a separate condition, on a runway having a convex upward shape that may be approximated by a slope of 1.5% at main landing gear stations.

Delete JAR 25.481

JAR 25.483 One-gear landing conditions.

(a) *Not applicable to A380.*

(b) For aeroplanes with more than two main landing gear units, a dynamic rolled landing condition on a level runway must be considered, using the assumptions specified in JAR 25.473, in which -

(1) The aeroplane is assumed to contact the ground -

(i) At the maximum roll angle attainable within the geometric limitations of the aeroplane (however, the roll angle need not exceed 10 degrees),

(ii) With a limit descent velocity of 2.13 m/sec (7 fps) at the design landing weight,

(iii) At the critical pitch attitudes and corresponding contact velocities obtained under JAR 25.480.

(2) The dynamic analysis must include the contact of all gear units outboard of the aeroplane centreline on the side of first gear impact. This condition need not apply to the gear units on the opposite side of the aeroplane.

(3) Side loads (in the ground reference system) may be assumed to be zero.

(4) Aeroplane rolling moments shall be reacted by aeroplane inertia forces and by subsequent main gear reactions.

JAR. 25.485 Side load conditions.

For the side load conditions specified in paragraphs (a) and (b) of this paragraph, the vertical and drag loads are assumed to act at the wheel axle centreline; and the side loads are assumed to act at the ground contact point. The gear loads are balanced by inertia of the aeroplane.

(a) The most severe combination of loads that are likely to arise during a lateral drift landing must be taken into account. In the absence of a more rational analysis of this condition, the following must be investigated:

(1) A separate condition for each gear unit, for which the vertical load is assumed to be 75% of the maximum vertical reaction obtained in JAR 25.480 or JAR 25.483(b) if applicable. For aeroplanes with more than two main landing gear units, the vertical load on other gear units is assumed to be 75% of the correlated vertical load for those gear units in the same condition. The vertical loads for each gear are combined with drag and side loads of 40% and 25%, respectively, of the vertical load.

(2) The aeroplane is assumed to be in the attitude corresponding to the maximum vertical reaction obtained in JAR 25.480 or JAR 25.483(b) if applicable.

(3) The shock absorber and tyre deflections must be assumed to be 75% of the deflection corresponding to the vertical loads obtained in JAR 25.480

(b) In addition to JAR 25.485(a), the following side load conditions must be considered for each main landing gear unit:

(1) A separate condition for each main landing gear unit, for which the vertical load is assumed to be 50% of the maximum vertical reaction obtained in JAR 25.480. For aeroplanes with more than two main gear units, the vertical load on other gear units is assumed to be 50% of the correlated vertical

load for those gear units in the same condition. The vertical loads for each gear unit are combined with the side loads specified in paragraph (b)(3) or (b)(4) of this paragraph, as applicable.

(2) The aeroplane is assumed to be in the attitude corresponding to the maximum vertical reaction obtained in JAR 25.480.

(3) For the outboard main landing gear units, side loads of 0.8 of the vertical reaction (on one side) acting inward and 0.6 of the vertical reaction (on the other side) acting outward as shown in figure 5 of Appendix A.

(4) For aeroplanes with more than two main landing gear units, the side load of each inboard main landing gear unit is determined by a linear interpolation between 0.8 and 0.6 of the vertical gear load on that gear, depending on the lateral position of that gear unit relative to the outboard main landing gear units. The side loads act in the same direction as the outboard main gear unit side loads.

(5) The drag loads may be assumed to be zero.

(6) The shock absorber and tyre deflections must be assumed to be 50% of the deflection corresponding to the vertical loads of JAR 25.480.

JAR 25.489 Ground handling conditions.

(a) Unless otherwise prescribed, the landing gear and aeroplane structure must be investigated for the conditions in JAR 25.491 to JAR 25.509 as follows:

(1) The aeroplane must be assumed to be at the design ramp weight (the maximum weight for ground handling conditions);

(2) The aeroplane lift must be assumed to be zero;

(3) The shock absorbers and tyres may be assumed to be in their static position.

(b) For aeroplanes with more than two main landing gear units, the aeroplane must be considered to be on a level runway and, as a separate condition, on a runway having a convex upward shape that may be approximated by a slope of 1.5% at the main landing gear stations. The ground reactions must be distributed to the individual landing gear units in a rational or conservative manner.

JAR 25.491 Taxi, takeoff and landing roll.

Within the range of appropriate ground speeds and approved weights, the aeroplane structure and landing gear are assumed to be subjected to loads not less than those obtained when the aircraft is operating over the roughest ground that may reasonably be expected in normal operation. Steady aerodynamic effects must be considered in a rational or conservative manner.

JAR 25.493 Braked roll conditions.

(a) *Not applicable to A380.*

(b) For an aeroplane with a nose wheel, the limit vertical load factor is 1.2 at the design landing weight, and 1.0 at the design ramp weight. A drag reaction equal to the vertical reaction, multiplied by a coefficient of friction of 0.8, must be combined with the vertical reaction and applied at the ground contact point of each wheel with brakes. The following two attitudes, in accordance with figure 6 of Appendix A, must be considered:

(1) The level attitude with the wheels contacting the ground and the loads distributed between the main and nose gear. Zero pitching acceleration is assumed.

(2) The level attitude with only the main gear units contacting the ground and with the pitching moment resisted by angular acceleration.

(c) An aeroplane equipped with a nose gear must be designed to withstand the loads arising from the dynamic pitching motion of the aeroplane due to sudden application of maximum braking force. The aeroplane is considered to be at design takeoff weight with the nose and main gears in contact with the ground, and with a steady-state vertical load factor of 1.0. The steady-state nose gear reaction must be combined with the maximum incremental nose gear vertical reaction caused by the sudden application of maximum braking force as described in paragraphs (b) and (e) of this paragraph.

(d) *Not applicable to A380.*

(e) A drag reaction lower than that prescribed in this paragraph may be used if it is substantiated that an effective drag force of 0.8 times the vertical reaction cannot be attained under any likely loading condition.

JAR 25.499 Nose-wheel yaw and steering.

- (a) A vertical load factor of 1.0 at the aeroplane centre of gravity, and a side component at the nose wheel ground contact equal to 0.8 of the vertical ground reaction at that point are assumed.
- (b) With the aeroplane assumed to be in static equilibrium with the loads resulting from the use of brakes on one side of the main landing gear system, the nose gear, its attaching structure, and the fuselage structure forward of the centre of gravity must be designed for the following loads:
- (1) A vertical load factor at the centre of gravity of 1.0.
 - (2) For wheels with brakes applied, the coefficient of friction must be 0.8. Drag loads are balanced by aeroplane inertia. Aeroplane pitching moment is reacted by the nose gear.
 - (3) Side and vertical loads at the ground contact point on the nose gear that are required for static equilibrium.
 - (4) A side load factor at the aeroplane centre of gravity of zero.
- (c) If the loads prescribed in paragraph (b) of this paragraph result in a nose gear side load higher than 0.8 times the vertical nose gear load, the design nose gear side load may be limited to 0.8 times the vertical load, with unbalanced yawing moments assumed to be resisted by aeroplane inertia forces.
- (d) For other than the nose gear, its attaching structure, and the forward fuselage structure, the loading conditions are those prescribed in paragraph (b) of this paragraph, except that--
- (1) A lower drag reaction may be used if an effective drag force of 0.8 times the vertical reaction cannot be reached under any likely loading condition; and
 - (2) The forward acting load at the centre of gravity need not exceed the maximum drag reaction on the main landing gear, determined in accordance with JAR 25.493(b).
- (e) With the aeroplane at design ramp weight, and the nose gear in any steerable position, the combined application of full normal steering torque and vertical force equal to 1.33 times the maximum static reaction on the nose gear must be considered in designing the nose gear, its attaching structure, and the forward fuselage structure.

JAR 25.503 Pivoting

The main landing gear and supporting structure must be designed for the loads induced by pivoting during ground manoeuvres in paragraph (a) or (b) of this paragraph, as applicable.

(a) *Not applicable to A380.*

(b) For aeroplanes with more than two main landing gear units, the following pivoting conditions must be considered:

- (1) The following rational pivoting manoeuvres must be considered:
 - (i) Towing at the nose gear at the critical towing angle, no brakes applied, and separately,
 - (ii) Application of symmetrical or unsymmetrical forward thrust to aid pivoting and with or without braking by pilot action on the pedals.
- (2) The aeroplane is assumed to be in static equilibrium, with the loads being applied at the ground contact points.
- (3) The limit vertical load factor must be 1.0, and
 - (i) For wheels with brakes applied, the coefficient of friction must be 0.8.
 - (ii) For wheels with brakes not applied, the ground tyre reactions must be based on reliable tyre data.
- (4) The failure conditions must be analysed in accordance with the principles of Special Condition C-11 (NPA 25C-199) "Interaction of Systems and Structure".

JAR 25.507 Reversed braking.

(a) The aeroplane must be in a static ground attitude. Horizontal reactions parallel to the ground and directed forward must be applied at the ground contact point of each wheel with brakes. The limit loads must be equal to 0.55 times the vertical load at each wheel or to the load developed by 1.2 times the nominal maximum static brake torque, whichever is less.

(b) For aeroplanes with nose wheels, the pitching moment must be balanced by rotational inertia.

(c) *Not applicable to A380.*

JAR 25.511 Ground load: unsymmetrical loads on multiple-wheel units.

Subparagraphs (d) and (e) are replaced by:

(d) *Landing conditions.* For one and for two deflated tyres, the applied load to each gear unit is assumed to be 60 percent and 50 percent, respectively, of the limit load applied to each gear for each of the prescribed landing conditions. However, for the side load condition of JAR 25.485(b), 100 percent of the vertical load must be applied. JAR 25.485(a) need not be considered with deflated tyres.

(e) *Taxiing and ground handling conditions.* For one and for two deflated tyres-

- (1) The applied side or drag load factor, or both factors, at the centre of gravity must be the most critical value up to 50 percent and 40 percent, respectively, of the limit side or drag load factors, or both factors, corresponding to the most severe condition resulting from consideration of the prescribed taxiing and ground handling conditions;
- (2) For the braked roll conditions of JAR 25.493(a) and (b)(2), the drag loads on each inflated tyre may not be less than those at each tyre for the symmetrical load distribution with no deflated tyres;
- (3) The vertical load factor at the centre of gravity must be 60 percent and 50 percent, respectively, of the factor with no deflated tyres, except that it may not be less than 1g; and
- (4) The pivoting condition of JAR 25.503 and the braked roll conditions of JAR 25.493 (c) and (d) need not be considered with deflated tyres.

JAR 25.519 Jacking and tie-down provisions.

Subparagraph b(1) is replaced by:

(b)(1) For jacking by the landing gear at the maximum ramp weight of the aeroplane, the aeroplane structure must be designed for a vertical load of 1.33 times the vertical static reaction at each jacking point acting singly and in combination with a horizontal load of 0.33 times the vertical static reaction applied in any direction. For aeroplanes with more than two main landing gear units, redistribution of vertical ground reactions must be considered.

JAR 25.723 Shock absorption tests.

(a) The analytical representation of the landing gear dynamic characteristics that is used in determining the landing loads must be validated by energy absorption tests. A range of tests must be conducted to ensure that the analytical representation is valid for the design conditions specified in JAR 25.480 and in JAR25.483(b) if applicable.

(1) The configurations subjected to energy absorption tests at limit design conditions must include both the condition with the maximum energy absorbed by the landing gear and the condition with the maximum descent velocity obtained from JAR 25.480 and JAR 25.483(b) if applicable.

(2) The test attitude of the landing gear unit and the application of appropriate drag loads during the test must simulate the aeroplane landing conditions in a manner consistent with the development of rational or conservative limit loads.

(b) Each landing gear unit may not fail in a test, demonstrating its reserve energy absorption capacity, assuming--

(1) The weight and pitch attitude correspond to the condition from JAR 25.480 or JAR 25.483(b), if applicable, that provides the maximum energy absorbed by the landing gear;

(2) Aeroplane lift is not greater than the aeroplane weight acting during the landing impact, unless the presence of systems or procedures significantly affects the lift;

(3) The test descent velocity is 120% of that corresponding to the condition specified in paragraph (b)(1) of this paragraph;

(4) The effects of wheel spin-up need not be included.

(c) In lieu of the tests prescribed in this paragraph, changes in previously approved design weights and minor changes in design may be substantiated by analyses based on previous tests conducted on the same basic landing gear system that has similar energy absorption characteristics.

INTERPRETATIVE MATERIAL

PART 1

ACJ 25.491

1. **PURPOSE.** This advisory circular (AC) sets forth acceptable methods of compliance with the provisions of part 25 of the Federal Aviation Regulations (FAR) dealing with the certification requirements for taxi, take-off and landing roll design loads. Guidance information is provided for showing compliance with § 25.491 of the FAR, relating to structural design for aeroplane operation on paved runways and taxiways normally used in

commercial operations. Other methods of compliance with the requirements may be acceptable.

2. RELATED FAR SECTIONS. The contents of this AC are considered by the Federal Aviation Administration (FAA) in determining compliance with § 25.491 of the FAR. Related sections are §§ 25.305(c) and 25.235.

3. BACKGROUND.

- a. All paved runways and taxiways have an inherent degree of surface unevenness, or roughness. This is the result of the normal tolerances of engineering standards required for construction, as well as the result of events such as uneven settlement and frost heave. In addition, repair of surfaces on an active runway or taxiway can result in temporary ramped surfaces. Many countries have developed criteria for runway surface roughness. The International Civil Aviation Organisation (ICAO) standards are published in ICAO Annex 14.
- b. In the late 1940's, as aeroplanes became larger, more flexible, and operated at higher ground speeds, consideration of dynamic loads during taxi, landing rollout, and take-off became important in aeroplane design. The Civil Aeronautics Administration, in Civil Air Regulations 4b (CAR 4b), § 4b.172, required the effects of landing gear deflection during taxiing over the roughest ground expected in service to be considered relative to its effect on damage to structural components. The CAR 4b, § 4b.235, also required the aeroplane be designed, in part, to withstand loads calculated under § 4b.172. Those regulations were carried over to part 25 of the FAR as § 25.235 and § 25.491 respectively. Substantiation of the effect of ground loads on flexible structure is required by § 25.305(c).
- c. Several approaches had been taken by different manufacturers in complying with the noted regulations. If dynamic effects due to rigid body modes or airframe flexibility during taxi were not considered critical, some manufacturers used a simplified static analysis where a static inertia force was applied to the aeroplane using a load factor of 2.0 for single axle gears or 1.7 for multiple axle gears. The lower 1.7 factor was justified based on an assumption that there was a load alleviating effect resulting from rotation of the beam, on which the forward and aft axles are attached, about the central pivot point on the strut. The static load factor approach was believed to encompass any dynamic effects and it had the benefit of a relatively simple analysis.
- d. As computers became more powerful and dynamic analysis methods became more sophisticated, it was found that dynamic effects sometimes resulted in loads greater than those which were predicted by the static criterion. Some manufacturers performed calculations using a series of harmonic bumps to represent a runway surface, tuning the bumps to excite various portions of the structure at a given speed. U.S. Military Standard 8862 defines amplitude and wavelengths of 1-cosine bumps intended to excite low speed plunge, pitch and wing first bending modes.
- e. Some manufacturers used actual runway profile data to calculate loads. The runway profiles of the San Francisco Runway 28R or Anchorage Runway 24, which were known to cause high loads on aeroplanes and were the subject of pilot complaints until resurfaced, have been used in a series of bi-directional constant speed analytical runs to determine loads. In some cases, accelerated runs have been used, starting from several points along the runway. The profiles of those runways are described in NASA Reports CR-119 and TN D-5703. Such deterministic dynamic analyses have in general proved to be satisfactory.
- f. Some manufacturers have used a statistical power spectral density (PSD) approach, especially to calculate fatigue loads. Extensive PSD runway roughness data exist for numerous world runways. The PSD approach is not considered practical for calculation of limit loads.

- g. Because the various methods described above produce different results, the guidance information given in paragraphs 4, 5, and 6 of this AC should be used when demonstrating compliance with § 25.491.
- h. For aeroplanes with more than two main landing gears, a runway crown as defined in 25.489(b) must also be considered in combination with section 4 and 5 of this AC.

4. RUNWAY PROFILE CONDITION.

- a. Consideration of airframe flexibility and landing gear dynamic characteristics is necessary in most cases. A deterministic dynamic analysis, based on the San Francisco Runway 28R (before it was resurfaced), described in Table 1 of this AC, is an acceptable method for compliance. As an alternative means of compliance, the San Francisco Runway 28R (before it was resurfaced) may be used with the severe bump from 1530 to 1538 feet modified per Table 2. The modifications to the bump reflect the maximum slope change permitted in ICAO Annex 14 for temporary ramps used to transition asphalt overlays to existing pavement. The points affected by this modification are outlined in Table 1.
- b. Aeroplane design loads should be developed for the most critical conditions arising from taxi, take-off, and landing run. The aeroplane analysis model should include significant aeroplane rigid body and flexible modes, and the appropriate landing gear and tyre characteristics. Unless the aeroplane has design features that would result in significant asymmetric loads, only the symmetric cases need be investigated.
- c. Aeroplane steady aerodynamic effects should normally be included. However, they may be ignored if their deletion is shown to produce conservative loads. Unsteady aerodynamic effects on dynamic response may be neglected.
- d. Conditions should be run at the maximum take-off weight and the maximum landing weight with critical combinations of wing fuel, payload, and extremes of centre of gravity (c.g.) range. For aeroplanes with trimable stabilisers, the stabiliser should be at the appropriate setting for take-off cases and at the recommended final approach setting for landing cases. The elevator should be assumed faired relative to the stabiliser throughout the take-off or landing run, unless other normal procedures are specified in the flight manual.
- e. A series of constant speed runs should be made in both directions from 20 knots up to the maximum ground speeds expected in normal operation (V_R defined at maximum altitude and temperature for take-off conditions, $1.25 V_{L2}$ for landing conditions). Sufficiently small speed increments should be evaluated to assure that maximum loads are achieved. Constant speed runs should be made because using accelerated runs may not define the speed/roughness points which could produce peak dynamic loads. For maximum take-off weight cases, the analysis should account for normal take-off flap and control settings and consider both zero and maximum thrust. For maximum landing weight cases, the analysis should account for normal flap and spoiler positions following landing, and steady pitching moments equivalent to those produced by braking with a coefficient of friction of 0.3 with and without reverse thrust. The effects of automatic braking systems that reduce braking in the presence of reverse thrust may be taken into account.

5. DISCRETE LOAD CONDITION. One of the following discrete limit load conditions should be evaluated:

- a. With all landing gears in contact with the ground, an aeroplane static load factor of 1.7 reacted by the landing gear should be investigated under the most adverse aeroplane loading distribution at maximum take-off weight, with and without thrust from the engines;
- b. As an alternative to paragraph 5(a) above, it would be acceptable to undertake dynamic analyses under the same conditions considered in paragraph 4 of this AC

considering the aircraft response to each of the following pairs of identical and contiguous 1-cosine upwards bumps on an otherwise smooth runway:

- (i) Bump wavelengths equal to the mean longitudinal distance between nose and main landing gears, or between the main and tail landing gears, as appropriate; and separately.
- (ii) Bump wavelengths equal to twice this distance.

The bump height in each case should be defined as:

$$H = 1.2 + 0.023 \sqrt{L}$$

Where:

- H = the bump height (inches)
- L = the bump wavelength (inches)

- (iii) In addition, for aeroplanes with more than two main landing gears, D will be defined as the distance between nose landing gear and the centroid of the main landing gear one g static load reaction. Bump wavelengths equal to 0.5D to 3D with a maximum wavelength increment of 0.5D should be considered.

6. COMBINED LOAD CONDITION. A condition of combined vertical, side and drag loads should be investigated for the main landing gear. In the absence of a more rational analysis a vertical load equal to 90% of the ground reaction from paragraph 5 above should be combined with a drag load of 20% of the vertical load and a side load of 20% of the vertical load. Side loads acting either direction should be considered.

7. TYRE CONDITIONS. The calculation of maximum gear loads in accordance with paragraphs 4, 5, and 6, may be performed using fully inflated tyres. For multiple wheel units, the maximum gear loads should be distributed between the wheels in accordance with the criteria of § 25.511.

TABLE 1

SAN FRANCISCO RUNWAY 28R

ONE TRACK

LENGTH: 3880 FEET

NUMBER OF POINTS: 1941

POINT SPACING: 2 FEET

ELEVATIONS: FEET

REFERENCE SOURCE: REPORT TO NASA (EFFECTS OF RUNWAY UNEVENNESS ON THE DYNAMIC RESPONSE OF SUPERSONIC TRANSPORTS), JULY 1964, U. OF CALIF. BERKLEY.

RUNWAY ELEVATION POINTS IN FEET (READ ROW WISE):

Dist.	Elev.	Dist.	Elev.	Dist.	Elev.	Dist.	Elev.	Dist.	Elev.	Dist.	Elev.	Dist.	Elev.	Dist.	Elev.
0.00	10.30	2.00	10.31	4.00	10.30	6.00	10.30	8.00	10.31	10.00	10.32	12.00	10.33	14.00	10.34
16.00	10.35	18.00	10.36	20.00	10.36	22.00	10.37	24.00	10.37	26.00	10.37	28.00	10.38	30.00	10.39
32.00	10.40	34.00	10.40	36.00	10.41	38.00	10.41	40.00	10.42	42.00	10.43	44.00	10.43	46.00	10.44
48.00	10.44	50.00	10.44	52.00	10.44	54.00	10.44	56.00	10.45	58.00	10.46	60.00	10.47	62.00	10.47
64.00	10.48	66.00	10.49	68.00	10.49	70.00	10.50	72.00	10.50	74.00	10.50	76.00	10.50	78.00	10.50
80.00	10.50	82.00	10.49	84.00	10.49	86.00	10.49	88.00	10.49	90.00	10.50	92.00	10.50	94.00	10.51
96.00	10.51	98.00	10.52	100.00	10.52	102.00	10.52	104.00	10.53	106.00	10.53	108.00	10.54	110.00	10.54
112.00	10.55	114.00	10.55	116.00	10.55	118.00	10.55	120.00	10.54	122.00	10.55	124.00	10.55	126.00	10.56
128.00	10.57	130.00	10.57	132.00	10.57	134.00	10.57	136.00	10.57	138.00	10.58	140.00	10.57	142.00	10.57
144.00	10.58	146.00	10.57	148.00	10.56	150.00	10.56	152.00	10.56	154.00	10.56	156.00	10.56	158.00	10.56
160.00	10.56	162.00	10.56	164.00	10.55	166.00	10.55	168.00	10.55	170.00	10.56	172.00	10.57	174.00	10.57
176.00	10.57	178.00	10.57	180.00	10.56	182.00	10.55	184.00	10.55	186.00	10.55	188.00	10.55	190.00	10.55
192.00	10.56	194.00	10.56	196.00	10.56	198.00	10.56	200.00	10.55	202.00	10.54	204.00	10.53	206.00	10.52
208.00	10.52	210.00	10.52	212.00	10.52	214.00	10.52	216.00	10.52	218.00	10.53	220.00	10.52	222.00	10.52
224.00	10.51	226.00	10.52	228.00	10.52	230.00	10.51	232.00	10.52	234.00	10.52	236.00	10.53	238.00	10.53
240.00	10.53	242.00	10.53	244.00	10.53	246.00	10.53	248.00	10.53	250.00	10.53	252.00	10.53	254.00	10.52
256.00	10.53	258.00	10.54	260.00	10.54	262.00	10.54	264.00	10.54	266.00	10.54	268.00	10.54	270.00	10.55

272.00	10.55	274.00	10.54	276.00	10.55	278.00	10.55	280.00	10.56	282.00	10.57	284.00	10.58	286.00	10.59
288.00	10.60	290.00	10.61	292.00	10.62	294.00	10.63	296.00	10.65	298.00	10.66	300.00	10.66	302.00	10.67
304.00	10.66	306.00	10.67	308.00	10.67	310.00	10.67	312.00	10.67	314.00	10.67	316.00	10.66	318.00	10.66
320.00	10.65	322.00	10.65	324.00	10.65	326.00	10.65	328.00	10.66	330.00	10.67	332.00	10.67	334.00	10.67
336.00	10.68	338.00	10.68	340.00	10.68	342.00	10.69	344.00	10.69	346.00	10.69	348.00	10.70	350.00	10.71
352.00	10.71	354.00	10.72	356.00	10.72	358.00	10.71	360.00	10.72	362.00	10.72	364.00	10.72	366.00	10.71
368.00	10.72	370.00	10.72	372.00	10.73	374.00	10.73	376.00	10.74	378.00	10.75	380.00	10.75	382.00	10.78
384.00	10.77	386.00	10.78	388.00	10.79	390.00	10.80	392.00	10.81	394.00	10.81	396.00	10.82	398.00	10.83
400.00	10.84	402.00	10.85	404.00	10.86	406.00	10.86	408.00	10.86	410.00	10.86	412.00	10.85	414.00	10.86
416.00	10.86	418.00	10.87	420.00	10.87	422.00	10.87	424.00	10.87	426.00	10.87	428.00	10.86	430.00	10.85
432.00	10.84	434.00	10.84	436.00	10.83	438.00	10.83	440.00	10.84	442.00	10.85	444.00	10.86	446.00	10.87
448.00	10.87	450.00	10.88	452.00	10.89	454.00	10.90	456.00	10.92	458.00	10.93	460.00	10.94	462.00	10.95
464.00	10.95	466.00	10.95	468.00	10.95	470.00	10.95	472.00	10.95	474.00	10.96	476.00	10.97	478.00	10.98
480.00	10.98	482.00	10.99	484.00	10.99	486.00	10.99	488.00	11.00	490.00	11.01	492.00	11.01	494.00	11.01
496.00	11.01	498.00	10.98	500.00	10.96	502.00	10.95	504.00	10.95	506.00	10.95	508.00	10.96	510.00	10.97
512.00	10.97	514.00	10.98	516.00	10.97	518.00	10.97	520.00	10.98	522.00	10.99	524.00	11.00	526.00	11.01
528.00	11.03	530.00	11.03	532.00	11.03	534.00	11.03	536.00	11.03	538.00	11.03	540.00	11.03	542.00	11.03
544.00	11.02	546.00	11.02	548.00	11.03	550.00	11.04	552.00	11.05	554.00	11.05	556.00	11.04	558.00	11.06
560.00	11.07	562.00	11.07	564.00	11.08	566.00	11.08	568.00	11.09	570.00	11.10	572.00	11.12	574.00	11.13
576.00	11.14	578.00	11.14	580.00	11.15	582.00	11.16	584.00	11.17	586.00	11.17	588.00	11.17	590.00	11.17
592.00	11.17	594.00	11.18	596.00	11.18	598.00	11.18	600.00	11.17	602.00	11.17	604.00	11.17	606.00	11.17
608.00	11.19	610.00	11.17	612.00	11.18	614.00	11.18	616.00	11.18	618.00	11.19	620.00	11.19	622.00	11.19
624.00	11.20	626.00	11.21	628.00	11.21	630.00	11.21	632.00	11.20	634.00	11.20	636.00	11.20	638.00	11.19
640.00	11.18	642.00	11.18	644.00	11.17	646.00	11.16	648.00	11.15	650.00	11.14	652.00	11.14	654.00	11.14
656.00	11.12	658.00	11.11	660.00	11.09	662.00	11.09	664.00	11.09	666.00	11.09	668.00	11.09	670.00	11.09
672.00	11.09	674.00	11.09	676.00	11.09	678.00	11.09	680.00	11.09	682.00	11.09	684.00	11.09	686.00	11.08
688.00	11.08	690.00	11.08	692.00	11.08	694.00	11.07	696.00	11.06	698.00	11.05	700.00	11.04	702.00	11.03
704.00	11.02	706.00	11.01	708.00	11.00	710.00	10.99	712.00	10.99	714.00	10.98	716.00	10.99	718.00	10.98
720.00	10.98	722.00	10.98	724.00	10.98	726.00	10.98	728.00	10.98	730.00	10.99	732.00	10.99	734.00	11.00
736.00	11.00	738.00	11.00	740.00	11.00	742.00	11.00	744.00	11.01	746.00	11.02	748.00	11.02	750.00	11.02
752.00	11.02	754.00	11.02	756.00	11.02	758.00	11.01	760.00	11.01	762.00	11.00	764.00	11.00	766.00	11.00
768.00	11.00	770.00	11.00	772.00	11.00	774.00	10.99	776.00	10.99	778.00	10.98	780.00	10.99	782.00	10.99
784.00	11.00	786.00	11.01	788.00	11.01	790.00	11.01	792.00	11.03	794.00	11.04	796.00	11.03	798.00	11.05
800.00	11.06	802.00	11.07	804.00	11.06	806.00	11.07	808.00	11.08	810.00	11.08	812.00	11.08	814.00	11.09
816.00	11.09	818.00	11.08	820.00	11.08	822.00	11.08	824.00	11.08	826.00	11.08	828.00	11.08	830.00	11.07
832.00	11.08	834.00	11.08	836.00	11.08	838.00	11.08	840.00	11.09	842.00	11.08	844.00	11.08	846.00	11.07

848.00	11.07	850.00	11.06	852.00	11.05	854.00	11.05	856.00	11.04	858.00	11.05	860.00	11.04	862.00	11.04
864.00	11.04	866.00	11.04	868.00	11.04	870.00	11.04	872.00	11.04	874.00	11.03	876.00	11.03	878.00	11.03
880.00	11.03	882.00	11.02	884.00	11.02	886.00	11.02	888.00	11.02	890.00	11.02	892.00	11.02	894.00	11.03
896.00	11.03	898.00	11.04	900.00	11.05	902.00	11.05	904.00	11.06	906.00	11.06	908.00	11.06	910.00	11.07
912.00	11.07	914.00	11.07	916.00	11.07	918.00	11.07	920.00	11.08	922.00	11.08	924.00	11.07	926.00	11.07
928.00	11.07	930.00	11.06	932.00	11.06	934.00	11.06	936.00	11.06	938.00	11.06	940.00	11.07	942.00	11.07
944.00	11.08	946.00	11.08	948.00	11.09	950.00	11.09	952.00	11.09	954.00	11.09	956.00	11.10	958.00	11.09
960.00	11.09	962.00	11.09	964.00	11.09	966.00	11.08	968.00	11.08	970.00	11.07	972.00	11.07	974.00	11.06
976.00	11.07	978.00	11.09	980.00	11.10	982.00	11.10	984.00	11.11	986.00	11.11	988.00	11.12	990.00	11.12
992.00	11.12	994.00	11.11	996.00	11.11	998.00	11.11	1000.00	11.11	1002.00	11.11	1004.00	11.10	1006.00	11.11
1008.00	11.11	1010.00	11.12	1012.00	11.12	1014.00	11.12	1016.00	11.11	1018.00	11.11	1020.00	11.12	1022.00	11.11
1024.00	11.11	1026.00	11.11	1028.00	11.10	1030.00	11.10	1032.00	11.12	1034.00	11.13	1036.00	11.15	1038.00	11.16
1040.00	11.17	1042.00	11.18	1044.00	11.18	1046.00	11.19	1048.00	11.19	1050.00	11.20	1052.00	11.22	1054.00	11.22
1056.00	11.23	1058.00	11.23	1060.00	11.23	1062.00	11.24	1064.00	11.25	1066.00	11.25	1068.00	11.26	1070.00	11.24
1072.00	11.27	1074.00	11.28	1076.00	11.28	1078.00	11.30	1080.00	11.31	1082.00	11.32	1084.00	11.33	1086.00	11.34
1088.00	11.34	1090.00	11.34	1092.00	11.34	1094.00	11.33	1096.00	11.32	1098.00	11.32	1100.00	11.31	1102.00	11.32
1104.00	11.32	1106.00	11.31	1108.00	11.31	1110.00	11.31	1112.00	11.32	1114.00	11.31	1116.00	11.32	1118.00	11.33
1120.00	11.34	1122.00	11.35	1124.00	11.35	1126.00	11.36	1128.00	11.36	1130.00	11.36	1132.00	11.37	1134.00	11.37
1136.00	11.37	1138.00	11.37	1140.00	11.38	1142.00	11.38	1144.00	11.38	1146.00	11.38	1148.00	11.38	1150.00	11.38
1152.00	11.38	1154.00	11.38	1156.00	11.38	1158.00	11.37	1160.00	11.37	1162.00	11.37	1164.00	11.37	1166.00	11.38
1168.00	11.38	1170.00	11.39	1172.00	11.38	1174.00	11.38	1176.00	11.39	1178.00	11.40	1180.00	11.41	1182.00	11.41
1184.00	11.42	1186.00	11.43	1188.00	11.44	1190.00	11.44	1192.00	11.45	1194.00	11.46	1196.00	11.46	1198.00	11.46
1200.00	11.46	1202.00	11.47	1204.00	11.48	1206.00	11.48	1208.00	11.48	1210.00	11.49	1212.00	11.50	1214.00	11.50
1216.00	11.50	1218.00	11.50	1220.00	11.50	1222.00	11.50	1224.00	11.49	1226.00	11.49	1228.00	11.49	1230.00	11.48
1232.00	11.47	1234.00	11.46	1236.00	11.46	1238.00	11.48	1240.00	11.46	1242.00	11.47	1244.00	11.47	1246.00	11.47
1248.00	11.47	1250.00	11.46	1252.00	11.45	1254.00	11.45	1256.00	11.45	1258.00	11.46	1260.00	11.46	1262.00	11.46
1264.00	11.45	1266.00	11.45	1268.00	11.45	1270.00	11.45	1272.00	11.45	1274.00	11.46	1276.00	11.46	1278.00	11.46
1280.00	11.48	1282.00	11.47	1284.00	11.47	1286.00	11.48	1288.00	11.48	1290.00	11.48	1292.00	11.48	1294.00	11.49
1296.00	11.49	1298.00	11.50	1300.00	11.51	1302.00	11.52	1304.00	11.52	1306.00	11.52	1308.00	11.52	1310.00	11.52
1312.00	11.52	1314.00	11.52	1316.00	11.53	1318.00	11.52	1320.00	11.52	1322.00	11.52	1324.00	11.53	1326.00	11.53
1328.00	11.53	1330.00	11.53	1332.00	11.53	1334.00	11.53	1336.00	11.54	1338.00	11.53	1340.00	11.52	1342.00	11.52
1344.00	11.51	1346.00	11.53	1348.00	11.52	1350.00	11.54	1352.00	11.53	1354.00	11.54	1356.00	11.53	1358.00	11.54
1360.00	11.53	1362.00	11.54	1364.00	11.55	1366.00	11.54	1368.00	11.54	1370.00	11.54	1372.00	11.54	1374.00	11.53
1376.00	11.52	1378.00	11.51	1380.00	11.50	1382.00	11.								

1424.00	11.47	1426.00	11.46	1428.00	11.46	1430.00	11.44	1432.00	11.43	1434.00	11.41	1436.00	11.40	1438.00	11.39
1440.00	11.38	1442.00	11.37	1444.00	11.36	1446.00	11.36	1448.00	11.35	1450.00	11.35	1452.00	11.35	1454.00	11.35
1456.00	11.35	1458.00	11.34	1460.00	11.34	1462.00	11.33	1464.00	11.32	1466.00	11.32	1468.00	11.32	1470.00	11.31
1472.00	11.31	1474.00	11.30	1476.00	11.29	1478.00	11.29	1480.00	11.28	1482.00	11.28	1484.00	11.28	1486.00	11.28
1488.00	11.28	1490.00	11.27	1492.00	11.27	1494.00	11.27	1496.00	11.26	1498.00	11.26	1500.00	11.25	1502.00	11.25
1504.00	11.24	1506.00	11.23	1508.00	11.22	1510.00	11.21	1512.00	11.19	1514.00	11.18	1516.00	11.17	1518.00	11.17
1520.00	11.15	1522.00	11.13	1524.00	11.12	1526.00	11.10	1528.00	11.10	1530.00	11.18	1532.00	11.17	1534.00	11.14
1536.00	11.14	1538.00	11.12	1540.00	11.00	1542.00	10.97	1544.00	10.95	1546.00	10.94	1548.00	10.92	1550.00	10.91
1552.00	10.92	1554.00	10.92	1556.00	10.91	1558.00	10.93	1560.00	10.93	1562.00	10.93	1564.00	10.93	1566.00	10.93
1568.00	10.93	1570.00	10.93	1572.00	10.93	1574.00	10.93	1576.00	10.93	1578.00	10.93	1580.00	10.94	1582.00	10.94
1584.00	10.94	1586.00	10.94	1588.00	10.95	1590.00	10.94	1592.00	10.93	1594.00	10.94	1596.00	10.94	1598.00	10.93
1600.00	10.92	1602.00	10.92	1604.00	10.92	1606.00	10.91	1608.00	10.91	1610.00	10.91	1612.00	10.91	1614.00	10.90
1616.00	10.89	1618.00	10.88	1620.00	10.87*	1622.00	10.89	1624.00	10.88	1626.00	10.88	1628.00	10.88	1630.00	10.87
1632.00	10.86	1634.00	10.85	1636.00	10.86	1638.00	10.86	1640.00	10.85	1642.00	10.85	1644.00	10.85	1646.00	10.84
1648.00	10.84	1650.00	10.84	1652.00	10.83	1654.00	10.83	1656.00	10.82	1658.00	10.82	1660.00	10.81	1662.00	10.81
1664.00	10.80	1666.00	10.79	1668.00	10.79	1670.00	10.79	1672.00	10.79	1674.00	10.79	1676.00	10.79	1678.00	10.80
1680.00	10.80	1682.00	10.81	1684.00	10.82	1686.00	10.82	1688.00	10.83	1690.00	10.84	1692.00	10.85	1694.00	10.85
1696.00	10.85	1698.00	10.87	1700.00	10.87	1702.00	10.88	1704.00	10.87	1706.00	10.88	1708.00	10.87	1710.00	10.87
1712.00	10.87	1714.00	10.87	1716.00	10.86	1718.00	10.85	1720.00	10.84	1722.00	10.84	1724.00	10.84	1726.00	10.84
1728.00	10.84	1730.00	10.83	1732.00	10.82	1734.00	10.82	1736.00	10.82	1738.00	10.82	1740.00	10.82	1742.00	10.82
1744.00	10.83	1746.00	10.82	1748.00	10.83	1750.00	10.82	1752.00	10.82	1754.00	10.82	1756.00	10.82	1758.00	10.81
1760.00	10.81	1762.00	10.81	1764.00	10.81	1766.00	10.82	1768.00	10.82	1770.00	10.82	1772.00	10.83	1774.00	10.83
1776.00	10.83	1778.00	10.84	1780.00	10.84	1782.00	10.85	1784.00	10.86	1786.00	10.86	1788.00	10.86	1790.00	10.88
1792.00	10.87	1794.00	10.86	1796.00	10.86	1798.00	10.86	1800.00	10.87	1802.00	10.87	1804.00	10.86	1806.00	10.85
1808.00	10.85	1810.00	10.89	1812.00	10.91	1814.00	10.91	1816.00	10.92	1818.00	10.92	1820.00	10.93	1822.00	10.93
1824.00	10.93	1826.00	10.94	1828.00	10.94	1830.00	10.95	1832.00	10.94	1834.00	10.93	1836.00	10.93	1838.00	10.92
1840.00	10.93	1842.00	10.91	1844.00	10.91	1846.00	10.90	1848.00	10.90	1850.00	10.90	1852.00	10.91	1854.00	10.91
1856.00	10.89	1858.00	10.90	1860.00	10.91	1862.00	10.91	1864.00	10.91	1866.00	10.92	1868.00	10.93	1870.00	10.94
1872.00	10.94	1874.00	10.94	1876.00	10.94	1878.00	10.94	1880.00	10.95	1882.00	10.93	1884.00	10.93	1886.00	10.93
1888.00	10.93	1890.00	10.92	1892.00	10.93	1894.00	10.93	1896.00	10.93	1898.00	10.93	1900.00	10.91	1902.00	10.90
1904.00	10.91	1906.00	10.91	1908.00	10.91	1910.00	10.91	1912.00	10.91	1914.00	10.91	1916.00	10.91	1918.00	10.90
1920.00	10.90	1922.00	10.89	1924.00	10.90	1926.00	10.90	1928.00	10.90	1930.00	10.91	1932.00	10.90	1934.00	10.91
1936.00	10.89	1938.00	10.89	1940.00	10.89	1942.00	10.89	1944.00	10.89	1946.00	10.88	1948.00	10.88	1950.00	10.87
1952.00	10.87	1954.00	10.87	1956.00	10.86	1958.00	10.88	1960.00	10.87	1962.00	10.86	1964.00	10.87	1966.00	10.87
1968.00	10.86	1970.00	10.85	1972.00	10.85	1974.00	10.85	1976.00	10.86	1978.00	10.85	1980.00	10.86	1982.00	10.86

1984.00	10.86	1986.00	10.87	1988.00	10.87	1990.00	10.87	1992.00	10.87	1994.00	10.87	1996.00	10.88	1998.00	10.87
2000.00	10.88	2002.00	10.87	2004.00	10.88	2006.00	10.88	2008.00	10.88	2010.00	10.88	2012.00	10.88	2014.00	10.89
2016.00	10.90	2018.00	10.89	2020.00	10.89	2022.00	10.89	2024.00	10.89	2026.00	10.90	2028.00	10.89	2030.00	10.89
2032.00	10.88	2034.00	10.87	2036.00	10.88	2038.00	10.87	2040.00	10.87	2042.00	10.87	2044.00	10.87	2046.00	10.88
2048.00	10.88	2050.00	10.88	2052.00	10.88	2054.00	10.88	2056.00	10.88	2058.00	10.89	2060.00	10.89	2062.00	10.89
2064.00	10.89	2066.00	10.89	2068.00	10.89	2070.00	10.89	2072.00	10.88	2074.00	10.88	2076.00	10.89	2078.00	10.88
2080.00	10.89	2082.00	10.88	2084.00	10.88	2086.00	10.88	2088.00	10.88	2090.00	10.88	2092.00	10.87	2094.00	10.87
2096.00	10.87	2098.00	10.87	2100.00	10.87	2102.00	10.88	2104.00	10.88	2106.00	10.88	2108.00	10.89	2110.00	10.89
2112.00	10.90	2114.00	10.91	2116.00	10.92	2118.00	10.92	2120.00	10.93	2122.00	10.92	2124.00	10.92	2126.00	10.92
2128.00	10.92	2130.00	10.92	2132.00	10.92	2134.00	10.92	2136.00	10.93	2138.00	10.93	2140.00	10.93	2142.00	10.93
2144.00	10.93	2146.00	10.94	2148.00	10.93	2150.00	10.93	2152.00	10.93	2154.00	10.93	2156.00	10.93	2158.00	10.92
2160.00	10.92	2162.00	10.91	2164.00	10.90	2166.00	10.92	2168.00	10.91	2170.00	10.91	2172.00	10.90	2174.00	10.90
2176.00	10.90	2178.00	10.88	2180.00	10.88	2182.00	10.86	2184.00	10.85	2186.00	10.85	2188.00	10.84	2190.00	10.84
2192.00	10.84	2194.00	10.84	2196.00	10.85	2198.00	10.85	2200.00	10.85	2202.00	10.85	2204.00	10.85	2206.00	10.85
2208.00	10.86	2210.00	10.86	2212.00	10.86	2214.00	10.87	2216.00	10.88	2218.00	10.88	2220.00	10.89	2222.00	10.90
2224.00	10.91	2226.00	10.91	2228.00	10.92	2230.00	10.92	2232.00	10.93	2234.00	10.94	2236.00	10.94	2238.00	10.95
2240.00	10.96	2242.00	10.96	2244.00	10.97	2246.00	10.99	2248.00	10.99	2250.00	10.99	2252.00	10.99	2254.00	11.00
2256.00	11.00	2258.00	11.00	2260.00	11.01	2262.00	11.01	2264.00	11.02	2266.00	11.02	2268.00	11.02	2270.00	11.04
2272.00	11.05	2274.00	11.05	2276.00	11.06	2278.00	11.06	2280.00	11.05	2282.00	11.04	2284.00	11.03	2286.00	11.03
2288.00	11.02	2290.00	11.03	2292.00	11.03	2294.00	11.04	2296.00	11.05	2298.00	11.06	2300.00	11.07	2302.00	11.09
2304.00	11.10	2306.00	11.10	2308.00	11.11	2310.00	11.12	2312.00	11.14	2314.00	11.14	2316.00	11.15	2318.00	11.16
2320.00	11.16	2322.00	11.16	2324.00	11.15	2326.00	11.15	2328.00	11.16	2330.00	11.15	2332.00	11.14	2334.00	11.14
2336.00	11.14	2338.00	11.14	2340.00	11.14	2342.00	11.14	2344.00	11.15	2346.00	11.15	2348.00	11.15	2350.00	11.15
2352.00	11.15	2354.00	11.15	2356.00	11.16	2358.00	11.16	2360.00	11.15	2362.00	11.15	2364.00	11.16	2366.00	11.16
2368.00	11.16	2370.00	11.16	2372.00	11.16	2374.00	11.16	2376.00	11.16	2378.00	11.16	2380.00	11.17	2382.00	11.17
2384.00	11.17	2386.00	11.17	2388.00	11.17	2390.00	11.17	2392.00	11.17	2394.00	11.16	2396.00	11.15	2398.00	11.15
2400.00	11.14	2402.00	11.14	2404.00	11.14	2406.00	11.13	2408.00	11.12	2410.00	11.12	2412.00	11.12	2414.00	11.12
2416.00	11.12	2418.00	11.12	2420.00	11.13	2422.00	11.13	2424.00	11.14	2426.00	11.15	2428.00	11.16	2430.00	11.17
2432.00	11.18	2434.00	11.19	2436.00	11.20	2438.00	11.20	2440.00	11.22	2442.00	11.23	2444.00	11.24	2446.00	11.24
2448.00	11.25	2450.00	11.26	2452.00	11.27	2454.00	11.28	2456.00	11.28	2458.00	11.29	2460.00	11.30	2462.00	11.30
2464.00	11.30	2466.00	11.31	2468.00	11.30	2470.00	11.31	2472.00	11.31	2474.00	11.31	2476.00	11.31	2478.00	11.30
2480.00	11.30	2482.00	11.30	2484.00	11.29	2486.00	11.29	2488.00	11.29	2490.00	11.29	2492.00	11.29	2494.00	11.29
2496.00	11.29	2498.00	11.29	2500.00	11.29	2502.00	11								

2560.00	11.35	2562.00	11.34	2564.00	11.33	2566.00	11.33	2568.00	11.33	2570.00	11.33	2572.00	11.33	2574.00	11.33
2576.00	11.33	2578.00	11.32	2580.00	11.33	2582.00	11.33	2584.00	11.33	2586.00	11.33	2588.00	11.33	2590.00	11.34
2592.00	11.34	2594.00	11.34	2596.00	11.35	2598.00	11.35	2600.00	11.35	2602.00	11.35	2604.00	11.35	2606.00	11.35
2608.00	11.35	2610.00	11.35	2612.00	11.36	2614.00	11.36	2616.00	11.36	2618.00	11.35	2620.00	11.35	2622.00	11.35
2624.00	11.35	2626.00	11.35	2628.00	11.35	2630.00	11.36	2632.00	11.36	2634.00	11.36	2636.00	11.36	2638.00	11.36
2640.00	11.37	2642.00	11.38	2644.00	11.38	2646.00	11.39	2648.00	11.39	2650.00	11.40	2652.00	11.41	2654.00	11.42
2656.00	11.42	2658.00	11.43	2660.00	11.43	2662.00	11.42	2664.00	11.42	2666.00	11.43	2668.00	11.43	2670.00	11.43
2672.00	11.43	2674.00	11.43	2676.00	11.43	2678.00	11.44	2680.00	11.44	2682.00	11.45	2684.00	11.46	2686.00	11.46
2688.00	11.47	2690.00	11.48	2692.00	11.48	2694.00	11.49	2696.00	11.49	2698.00	11.50	2700.00	11.50	2702.00	11.51
2704.00	11.52	2706.00	11.52	2708.00	11.52	2710.00	11.52	2712.00	11.52	2714.00	11.52	2716.00	11.52	2718.00	11.52
2720.00	11.52	2722.00	11.52	2724.00	11.51	2726.00	11.51	2728.00	11.51	2730.00	11.50	2732.00	11.50	2734.00	11.50
2736.00	11.50	2738.00	11.51	2740.00	11.51	2742.00	11.51	2744.00	11.52	2746.00	11.52	2748.00	11.52	2750.00	11.52
2752.00	11.53	2754.00	11.53	2756.00	11.53	2758.00	11.52	2760.00	11.52	2762.00	11.52	2764.00	11.52	2766.00	11.52
2768.00	11.52	2770.00	11.53	2772.00	11.53	2774.00	11.53	2776.00	11.54	2778.00	11.53	2780.00	11.53	2782.00	11.54
2784.00	11.54	2786.00	11.54	2788.00	11.54	2790.00	11.53	2792.00	11.53	2794.00	11.53	2796.00	11.53	2798.00	11.54
2800.00	11.54	2802.00	11.54	2804.00	11.55	2806.00	11.55	2808.00	11.55	2810.00	11.56	2812.00	11.55	2814.00	11.55
2816.00	11.55	2818.00	11.55	2820.00	11.54	2822.00	11.53	2824.00	11.53	2826.00	11.53	2828.00	11.51	2830.00	11.52
2832.00	11.52	2834.00	11.53	2836.00	11.53	2838.00	11.54	2840.00	11.55	2842.00	11.56	2844.00	11.56	2846.00	11.57
2848.00	11.57	2850.00	11.57	2852.00	11.58	2854.00	11.58	2856.00	11.58	2858.00	11.58	2860.00	11.58	2862.00	11.58
2864.00	11.59	2866.00	11.59	2868.00	11.59	2870.00	11.59	2872.00	11.58	2874.00	11.57	2876.00	11.57	2878.00	11.58
2880.00	11.57	2882.00	11.57	2884.00	11.57	2886.00	11.58	2888.00	11.58	2890.00	11.59	2892.00	11.60	2894.00	11.62
2896.00	11.61	2898.00	11.61	2900.00	11.61	2902.00	11.61	2904.00	11.61	2906.00	11.62	2908.00	11.63	2910.00	11.64
2912.00	11.65	2914.00	11.66	2916.00	11.67	2918.00	11.67	2920.00	11.67	2922.00	11.68	2924.00	11.70	2926.00	11.72
2928.00	11.73	2930.00	11.74	2932.00	11.76	2934.00	11.77	2936.00	11.78	2938.00	11.80	2940.00	11.82	2942.00	11.82
2944.00	11.82	2946.00	11.83	2948.00	11.82	2950.00	11.82	2952.00	11.83	2954.00	11.84	2956.00	11.83	2958.00	11.83
2960.00	11.83	2962.00	11.83	2964.00	11.83	2966.00	11.83	2968.00	11.84	2970.00	11.85	2972.00	11.86	2974.00	11.87
2976.00	11.88	2978.00	11.88	2980.00	11.89	2982.00	11.90	2984.00	11.90	2986.00	11.90	2988.00	11.90	2990.00	11.90
2992.00	11.90	2994.00	11.91	2996.00	11.91	2998.00	11.90	3000.00	11.91	3002.00	11.91	3004.00	11.91	3006.00	11.91
3008.00	11.90	3010.00	11.91	3012.00	11.91	3014.00	11.92	3016.00	11.92	3018.00	11.92	3020.00	11.92	3022.00	11.92
3024.00	11.92	3026.00	11.92	3028.00	11.91	3030.00	11.91	3032.00	11.92	3034.00	11.91	3036.00	11.91	3038.00	11.91
3040.00	11.91	3042.00	11.90	3044.00	11.90	3046.00	11.90	3048.00	11.90	3050.00	11.90	3052.00	11.90	3054.00	11.90
3056.00	11.90	3058.00	11.90	3060.00	11.90	3062.00	11.91	3064.00	11.92	3066.00	11.92	3068.00	11.92	3070.00	11.93
3072.00	11.93	3074.00	11.93	3076.00	11.93	3078.00	11.94	3080.00	11.94	3082.00	11.95	3084.00	11.95	3086.00	11.95
3088.00	11.96	3090.00	11.96	3092.00	11.96	3094.00	11.96	3096.00	11.96	3098.00	11.96	3100.00	11.95	3102.00	11.94
3104.00	11.93	3106.00	11.92	3108.00	11.92	3110.00	11.92	3112.00	11.92	3114.00	11.92	3116.00	11.92	3118.00	11.92
3120.00	11.92	3122.00	11.92	3124.00	11.92	3126.00	11.92	3128.00	11.91	3130.00	11.90	3132.00	11.90	3134.00	11.90
3136.00	11.90	3138.00	11.90	3140.00	11.90	3142.00	11.90	3144.00	11.90	3146.00	11.90	3148.00	11.90	3150.00	11.90
3152.00	11.90	3154.00	11.90	3156.00	11.90	3158.00	11.90	3160.00	11.90	3162.00	11.89	3164.00	11.88	3166.00	11.88
3168.00	11.87	3170.00	11.87	3172.00	11.86	3174.00	11.86	3176.00	11.85	3178.00	11.85	3180.00	11.84	3182.00	11.84
3184.00	11.84	3186.00	11.84	3188.00	11.84	3190.00	11.85	3192.00	11.87	3194.00	11.89	3196.00	11.89	3198.00	11.90
3200.00	11.89	3202.00	11.92	3204.00	11.95	3206.00	11.95	3208.00	11.95	3210.00	11.94	3212.00	11.94	3214.00	11.93
3216.00	11.92	3218.00	11.92	3220.00	11.91	3222.00	11.90	3224.00	11.90	3226.00	11.89	3228.00	11.88	3230.00	11.87
3232.00	11.86	3234.00	11.85	3236.00	11.84	3238.00	11.84	3240.00	11.84	3242.00	11.83	3244.00	11.82	3246.00	11.82
3248.00	11.81	3250.00	11.83	3252.00	11.83	3254.00	11.83	3256.00	11.84	3258.00	11.84	3260.00	11.84	3262.00	11.84
3264.00	11.82	3266.00	11.83	3268.00	11.82	3270.00	11.83	3272.00	11.83	3274.00	11.84	3276.00	11.84	3278.00	11.84
3280.00	11.85	3282.00	11.84	3284.00	11.84	3286.00	11.84	3288.00	11.85	3290.00	11.85	3292.00	11.85	3294.00	11.86
3296.00	11.86	3298.00	11.84	3300.00	11.84	3302.00	11.84	3304.00	11.84	3306.00	11.84	3308.00	11.84	3310.00	11.84
3312.00	11.84	3314.00	11.84	3316.00	11.84	3318.00	11.84	3320.00	11.84	3322.00	11.83	3324.00	11.83	3326.00	11.83
3328.00	11.82	3330.00	11.83	3332.00	11.83	3334.00	11.83	3336.00	11.82	3338.00	11.82	3340.00	11.83	3342.00	11.82
3344.00	11.83	3346.00	11.83	3348.00	11.84	3350.00	11.84	3352.00	11.83	3354.00	11.83	3356.00	11.83	3358.00	11.83
3360.00	11.83	3362.00	11.84	3364.00	11.84	3366.00	11.84	3368.00	11.85	3370.00	11.85	3372.00	11.85	3374.00	11.85
3376.00	11.84	3378.00	11.84	3380.00	11.85	3382.00	11.85	3384.00	11.86	3386.00	11.86	3388.00	11.87	3390.00	11.87
3392.00	11.87	3394.00	11.87	3396.00	11.87	3398.00	11.86	3400.00	11.87	3402.00	11.87	3404.00	11.88	3406.00	11.89
3408.00	11.89	3410.00	11.89	3412.00	11.91	3414.00	11.91	3416.00	11.92	3418.00	11.93	3420.00	11.95	3422.00	11.95
3424.00	11.96	3426.00	11.96	3428.00	11.96	3430.00	11.96	3432.00	11.95	3434.00	11.96	3436.00	11.96	3438.00	11.96
3440.00	11.96	3442.00	11.95	3444.00	11.95	3446.00	11.94	3448.00	11.96	3450.00	11.98	3452.00	11.99	3454.00	12.01
3456.00	12.03	3458.00	12.04	3460.00	12.05	3462.00	12.05	3464.00	12.05	3466.00	12.05	3468.00	12.05	3470.00	12.05
3472.00	12.04	3474.00	12.06	3476.00	12.06	3478.00	12.07	3480.00	12.07	3482.00	12.07	3484.00	12.07	3486.00	12.06
3488.00	12.07	3490.00	12.07	3492.00	12.08	3494.00	12.08	3496.00	12.08	3498.00	12.09	3500.00	12.09	3502.00	12.08
3504.00	12.08	3506.00	12.08	3508.00	12.08	3510.00	12.08	3512.00	12.09	3514.00	12.10	3516.00	12.10	3518.00	12.10
3520.00	12.10	3522.00	12.10	3524.00	12.11	3526.00	12.11	3528.00	12.12	3530.00	12.13	3532.00	12.13	3534.00	12.13
3536.00	12.13	3538.00	12.14	3540.00	12.14	3542.00	12.13	3544.00	12.13	3546.00	12.13	3548.00	12.11	3550.00	12.10
3552.00	12.07	3554.00	12.06	3556.00	12.07	3558.00	12.08	3560.00	12.09	3562.00	12.10	3564.00	12.11	3566.00	12.11
3568.00	12.12	3570.00	12.06	3572.00	12.01	3574.00	12.03	3576.00	12.04	3578.00	12.05	3580.00	12.05	3582.00	12.06
3584.00	12.06	3586.00	12.05	3588.00	12.04	3590.00	12.03	3592.00	12.02	3594.00	12.02	3596.00	12.02	3598.00	12.02
3600.00	12.01	3602.00	11.99	3604.00	11.98	3606.00	11.94	3608.00	11.94	3610.00	11.93	3612.00	11.93	3614.00	11.92
3616.00	11.91	3618.00	11.90	3620.00	11.90	3622.00	11.90	3624.00	11.90	3626.00	11.90	3628.00	11.91	3630.00	11.90
3632.00	11.88	3634.00	11.87	3636.00	11.87	3638.00	11.86	3640.00	11.86	3642.00	11.85	3644.00	11.86	3646.00	11.86
3648.00	11.85	3650.0													

3712.00	11.95	3714.00	11.96	3716.00	11.95	3718.00	11.95	3720.00	11.96	3722.00	11.97	3724.00	11.98	3726.00	11.98
3728.00	11.99	3730.00	12.00	3732.00	12.00	3734.00	11.99	3736.00	11.99	3738.00	11.99	3740.00	12.00	3742.00	12.00
3744.00	12.01	3746.00	12.02	3748.00	12.02	3750.00	12.03	3752.00	12.04	3754.00	12.05	3756.00	12.06	3758.00	12.06
3760.00	12.06	3762.00	12.06	3764.00	12.06	3766.00	12.06	3768.00	12.06	3770.00	12.06	3772.00	12.07	3774.00	12.08
3776.00	12.09	3778.00	12.10	3780.00	12.09	3782.00	12.12	3784.00	12.13	3786.00	12.14	3788.00	12.13	3790.00	12.14
3792.00	12.14	3794.00	12.14	3796.00	12.15	3798.00	12.15	3800.00	12.16	3802.00	12.16	3804.00	12.17	3806.00	12.17
3808.00	12.17	3810.00	12.15	3812.00	12.14	3814.00	12.13	3816.00	12.12	3818.00	12.11	3820.00	12.10	3822.00	12.09
3824.00	12.09	3826.00	12.09	3828.00	12.08	3830.00	12.07	3832.00	12.07	3834.00	12.06	3836.00	12.05	3838.00	12.03
3840.00	12.03	3842.00	12.02	3844.00	12.01	3846.00	12.02	3848.00	12.01	3850.00	12.01	3852.00	12.01	3854.00	12.01
3856.00	12.02	3858.00	12.02	3860.00	12.01	3862.00	12.00	3864.00	12.00	3866.00	11.98	3868.00	11.97	3870.00	11.97
3872.00	11.96	3874.00	11.96	3876.00	11.96	3878.00	11.96	3880.00	11.95						

*The National Aeronautics and Space Administration (NASA) Report CR-119 identifies an elevation of 10.97 feet at 1620 feet. This is considered a topographical error and has been corrected in Table 1. The elevation is 10.87 feet.

TABLE 2

SF28R SEVERE BUMP MODIFICATIONS
PER ICAO ANNEX 14, SPECIFICATION 9.4.15

Distance	Original Elevation (ft)	Modified Elevation (ft)
1530	11.18	11.10
1532	11.17	11.11
1534	11.14	11.11
1536	11.14	11.07
1538	11.12	11.04

PART 2

**Revoke ACJ 25.493(c)
ACJ 25.493**

The following may be considered as an acceptable approach for performing dynamic response calculations and for substantiating a drag load lower than 0.8 times the vertical load per JAR 25.493(e):

In seeking a reduced drag reaction, the most likely considerations would be limitations in brake energy absorption capability or limitations in tyre friction capability.

It would be acceptable to substantiate the brake energy absorption by dynamometer testing in which brake systems characteristics are included. Alternatively, maximum brake torque force could be substantiated by (aeroplane) ground tests performed under maximum effort braking conditions on dry runways. The maximum recorded brake torque force will be established from ground test covering all practical ranges of brake operating conditions likely to be encountered. In particular, the ranges of speed, temperature and operating pressure as well as manufacturing variability of the braking system should be considered. In addition, testing should be conducted with sufficient brake wear so as to maximise braking capability.

A tyre coefficient of friction lower than 0.8 may be used if it can be shown that, under application of maximum brake torque, the resulting drag load is less than 80% of the vertical load. The effects of tyre inflation pressure, tyre wear, runway characteristics, and manufacturing variability of the tyre should be assessed.

The coefficients of friction for JAR 25.493(b)(1) and (c) should include the low speed range where the anti-skid system (if installed) will not operate. Where sufficient brake torque exists to skid the tyres, the maximum coefficient of friction should be based upon the tyre maximum coefficient of friction for ground speeds approaching zero.

The JAR 25.493 (b)(2) conditions are most likely attainable at rotation speed during a take-off roll or immediately after touchdown during a landing run. Therefore, the coefficient of friction may be derived from tyre data generated at nominal rotation speed or nominal landing speed. In addition, anti-skid system effectiveness may be considered in developing the resulting loads.

The following may be used as guidance for determining the brake rise time and shape for compliance with JAR 25.493(c):

When performing dynamic response calculations, representative shock absorber and tyre characteristics should be included. No aerodynamic relief resulting from aeroplane pitch motion should be assumed.

Braking should be determined by application of the torque at the wheel axles according to the appropriate torque rise time history. (Alternatively, brake drag force may be modelled as tyre-to-ground friction coefficient multiplied by the instantaneous vertical ground reaction of the main gear.) It would be acceptable to conservatively substantiate the rise time and shape by dynamometer testing in which brake systems characteristics are included. Alternatively, maximum brake torque force, rise time and rise shape could be substantiated by (aeroplane) ground tests performed under maximum effort braking conditions on dry runways. In lieu of a more rational approach, the applied brake torque (or friction coefficient) should linearly rise to its maximum value in a rise time of 0.2 seconds, and then maintained constant.

PART 3

Proposed revisions to existing ACJ 25.723(a)

2. RELATED JAR SECTIONS. JAR 25.723 “Shock absorption tests,” and JAR 25.473 “Landing load assumptions,” JAR 25.480 “Symmetric landing load conditions,” and JAR 25.483 “One-gear landing conditions.”
3. SHOCK ABSORPTION TESTS.
 - a. Validation of the landing gear characteristics. Shock absorption tests are necessary to validate the analytical representation of the dynamic characteristics of the landing gear unit that will be used to determine the landing loads. A range of tests should be conducted to ensure that the analytical model is valid for all design conditions. The drop test attitude of the landing gear unit and the application of appropriate drag loads during the test must simulate the airplane landing conditions in a manner consistent with the development of rational or conservative limit loads. In addition, consideration should be given to ensuring that the range of test configurations is sufficient for justifying the use of the analytical model for foreseeable future growth versions of the airplane.
 - b. Recommended test conditions for new landing gear units.

All the conditions from Section 25.480 and Section 25.483(b), if applicable, should be considered when selecting suitable configurations for the energy absorption tests. Where the manufacturer has supporting data from previous experience in validating the analytical model using landing gear units of similar design concept, it may be sufficient to conduct tests of the new landing gear at only the condition associated with maximum energy. The landing gear used to provide the supporting data may be from another model aircraft but should be of approximately the same size with similar components. For all test conditions, both the sink rate at initial tire contact and the total energy absorbed by the landing gear shall not be less than that corresponding to the conditions selected from Section 25.480 and Section 25.483(b), if applicable.
4. EFFECTIVE DROP WEIGHTS.

If airplane lift is simulated by air cylinders or by other mechanical means, the weight used for the drop may not be less than W_e as defined below. The drop test lift should normally be

equal to the airplane lift, however, if this is not possible, the drop weight must be adjusted according to the equations below.

For free drop tests, the test lift is set to zero in these equations:

(a) For main landing gear units for airplanes with only two main landing gear units:

$$W_e = W_M + (L_T - L_A) d / (h + d)$$

(b) For main landing gear units for airplanes with more than two main landing gear units:

$$W_e = E_A / h, \quad \text{for test lift equal to test weight}$$

$$W_e = (E_A + L_T d) / (h + d), \quad \text{for test lift not equal to test weight}$$

(c) For nose gear units, the greater of (1) or (2) below:

$$(1) \quad W_e = E_A / h, \quad \text{for test lift equal to test weight}$$

$$W_e = (E_A + L_T d) / (h + d), \quad \text{for test lift not equal to test weight}$$

$$(2) \quad W_e = W_N, \quad \text{for test lift equal to test weight}$$

$$W_e = W_N + (L_T - W_N) d / (h + d), \quad \text{for test lift not equal to test weight}$$

(d) For tail gear units:

$$W_e = W_T, \quad \text{for test lift equal to test weight}$$

$$W_e = W_T + (L_T - W_T) d / (h + d), \quad \text{for test lift not equal to test weight}$$

(e) Where:

- W_e = the effective weight to be used in the drop test ;
- h = the theoretical free drop height corresponding to the required kinetic energy at the moment of touchdown, equal to: $V^2 / 2g$, where V is the sink rate, and g is the gravitational constant ;
- d = maximum distance of drop weight vertical travel after tire contact with the platform; (this value may not exceed the value actually obtained in the drop test);
- W_M = the static weight on that main gear unit with the airplane in the level attitude (with the nose wheel clear in the case of nose wheel type airplanes), typically one half of the weight of the airplane;
- W_T = the static weight on the tail unit with the airplane in the tail-down attitude;
- W_N = the vertical component of the static reaction that would exist at the nose gear, assuming that the mass of the airplane acts at the center of gravity and exerts a force of 1.0 g downward and 0.25 g forward;
- L_A = assumed airplane lift per gear, however, total airplane lift may not be greater than airplane weight;
- L_T = average drop test lift per gear during energy absorption phase of the drop test; (for free drop tests, L_T equals zero); and, E_A = maximum total energy absorbed by the landing gear unit obtained in the dynamic loads analysis in compliance with Section 25.480 or Section 25.483(b).

Delete Paragraph 5 Reserve energy Free Drop Tests

– END –

SPECIAL CONDITION:	C-04 SC: Undercarriage lateral turning loads
APPLICABILITY:	A380
REQUIREMENTS:	JAR 25.495
ADVISORY MATERIAL:	N/A

BACKGROUND

The current JAR 25.495 bookcase is inappropriate to address landing gear loading on a multiple leg aircraft in ground turn conditions.

Evidence exists to support the view that the overall lateral load factor of JAR 25.495, while valid for the majority of existing fleet, is overly severe when applied to very large aircraft. In addition, the A380 has key characteristics, such as the size and the landing gear configuration, that limit the maximum load factor that can be reached.

A Special Condition is therefore justified for this aircraft, introducing a rational loading condition for the ground turning case and defining an appropriate limit lateral load factor.

SPECIAL CONDITION

Replace the current 25.495 requirement by the following:

- (a) The aeroplane is assumed to execute a steady turn by steering of any steerable gear or by application of any differential power. The limit vertical load factor must be 1.0 and, in the absence of a more rational analysis, the limit aircraft lateral load factor must be 0.5.
- (b) The aeroplane is assumed to be in static balance, the lateral load factor being reacted by friction forces applied at the ground contact point of each tyre. The lateral load must be shared between each individual tyre in a rational or conservative manner. The distribution of the load on the tyre must account at least for the effects of the factors specified in the subparagraph (c)(2).
- (c) At max ramp weight, a limit value of lateral cg inertia factor lower than specified in subparagraph (a), but not less than 0.45g (wing axis) may be used if it can be shown by a rational analysis that this lower value cannot be exceeded. The rational analysis must consider at least the following:
 - (1) The maximum lateral load factor that can be reached during the full range of likely ground operations at maximum ramp weight including ground turning, “fishtailing” and high-speed runway exit. In each case, the full dynamic manoeuvre must be considered.
 - (2) The rational analysis must include at least the following parameters:
 - (i) Landing gear spring curves and landing gear kinematics
 - (ii) Reliable tyre friction characteristics
 - (iii) Airframe and landing gear flexibility when significant
 - (iv) Aircraft rigid body motion
 - (v) The worst combination of tyre diameter, tyre pressure and runway shapes specified in JAR 25.511(b)(2), 25.511(b)(3) and 25.511(b)(4).
- (d) The limit lateral load factor at MLW is 0.5. Details of the analysis and any assumptions used must be agreed with the Authority. Any limitation must be based on the intrinsic characteristics of the aircraft and must be independent of airfield geometry. Other influences that cannot be controlled by the aircraft design must be conservatively assessed.

– END –

SPECIAL CONDITION	C-05 SC: Jacking by Landing Gear
APPLICABILITY:	A380
REQUIREMENTS:	JAR 25.519(b)(1)
ADVISORY MATERIAL:	N/A

BACKGROUND

The A380 landing gear will include either a two or three legged body gear in addition to the conventional wing and nose gears.

Jacking, as defined by the landing gear bookcase (lifting of the whole aeroplane), is not adapted to complex multiple gear system operation.

In lieu of compliance with JAR 25.519(b)(1) (as modified by SC C-3), for jacking by the landing gear at the maximum ramp weight of the aeroplane, the aeroplane structure may be designed to withstand the maximum limit loads arising from the following conditions:

SPECIAL CONDITION

- (a) The loads arising from jacking by the landing gear may be derived from a rational analysis under the following conditions in combination;
 - (i) A ramp crown defined by a 1.5% gradient, the crest of the gradient to be in the most adverse position for the loading of the undercarriage unit in question.
The maximum allowable steady wind for jacking operations from any horizontal direction.
The most adverse combination of oleo leg pressures within service tolerances.
Jack(s) at the maximum possible overshoot.
 - (ii) A ramp crown defined by a 1.5% gradient, the crest of the gradient to be in the most adverse position for the loading of the undercarriage unit in question.
Twice the maximum allowable steady wind for jacking operations from any horizontal direction.
An nominal distribution of oleo leg pressures.
Jacking performed in accordance with recommended procedures.
- (b) The limit horizontal load at the jacking point undercarriage unit may not be less than the higher of that derived from the above rational analysis or 0.33 times the limit static vertical reaction found with the undercarriage unit in question supported at the jacking points with the aircraft in the unjacked position. This load must be applied in combination with the vertical loads arising from the analysis of (a) above.
- (c) Jacking systems for use in this operation must be to an Airbus defined specification that is consistent with the conditions of this analysis; jacking instructions must define which jacking systems are suitable for this operation. The maintenance crews must be informed of the need to strictly follow Airbus jacking instructions, and to use jacking systems acceptable for this operation, by means of placards conspicuously located near the jacking points, or other suitable means to be proposed by Airbus.

– END –

SPECIAL CONDITION:	C-06 SC: Dynamic Braking
APPLICABILITY:	A380
REQUIREMENTS:	JAR 25.493(d)(e)
ADVISORY MATERIAL:	N/A

BACKGROUND

The A380 landing gear will include either a two or three legged body gear in addition to the conventional wing and nose gears. This landing gear group may also result in more complex dynamic characteristics than found in conventional gears.

Due to the potential complexities of the A380 gear a rational analysis of the braked roll conditions of 25.493(d) is necessary.

SPECIAL CONDITION

“Loads arising from the sudden application of maximum braking effort must be defined taking into account the behaviour of the braking system. Failure conditions of the braking system must be analysed in accordance with the principles of Special Condition C-11 (NPA 25C-199), “Interaction of Systems and Structures”.”

– END –

SPECIAL CONDITION:	C-11 SC: Interaction of Systems and Structure
APPLICABILITY:	A380
REQUIREMENTS:	JAR 25 Subpart C and D
ADVISORY MATERIAL:	N/A

BACKGROUND

The A380 is equipped with systems which directly or as a result of failure or malfunction affect its structural performance. Certification loads for the aircraft must consider these effects of systems on structural performance. This must include normal operation and failure conditions with strength levels related to probability of occurrence.

There is a need to develop a special condition to account for these new features, in accordance with JAR 21.16(a)(1).

The draft NPRM - Interaction of Systems and Structures - dated 24 June 1999, has been accepted by the JAA / FAA Loads Harmonisation Working Group.

This draft NPRM is an evolution of the latest version of NPA 25C-199 (issue December 1996) and is considered to be technically more mature.

SPECIAL CONDITION

1. **Add a new paragraph § 25.302 to read as follows :**
§ 25.302 Interaction of systems and structures.

For aeroplanes equipped with systems that affect structural performance, either directly or as a result of a failure or malfunction, the influence of these systems and their failure conditions must be taken into account when showing compliance with the requirements of Subparts C and D. Appendix L must be used to evaluate the structural performance of aeroplanes equipped with these systems.

2. **JAR 25.305 is revised by adding sub-paragraphs (f) as follows:**

- (f) Unless shown to be extremely improbable, the aeroplane must be designed to withstand any forced structural vibration resulting from any failure, malfunction or adverse condition in the flight control system. These loads must be treated in accordance with the requirements of § 25.302.

3. **Add a new appendix L to read as follows :**
Appendix L to JAR-25 - Interaction of Systems and Structure

L25.1. General.

The following criteria must be used for showing compliance with § 25.302 and § 25.629 for aeroplanes equipped with flight control systems, autopilots, stability augmentation systems, load alleviation systems, flutter control systems, and fuel management systems. If this appendix is used for other systems, it may be necessary to adapt the criteria to the specific system.

- (a) The criteria defined herein only address the direct structural consequences of the system responses and performances and cannot be considered in isolation but should be included in the overall safety evaluation of the aeroplane. These criteria may in some instances duplicate standards already established for this evaluation. These criteria are only applicable to structure whose failure could prevent continued safe flight and landing. Specific criteria that define acceptable limits on handling characteristics or stability

requirements when operating in the system degraded or inoperative mode are not provided in this appendix.

- (b) Depending upon the specific characteristics of the aeroplane, additional studies may be required that go beyond the criteria provided in this appendix in order to demonstrate the capability of the aeroplane to meet other realistic conditions such as alternative gust or manoeuvre descriptions for an aeroplane equipped with a load alleviation system.
- (c) The following definitions are applicable to this appendix.

Structural performance: Capability of the aeroplane to meet the structural requirements of JAR 25.

Flight limitations: Limitations that can be applied to the aeroplane flight conditions following an in-flight occurrence and that are included in the flight manual (e.g., speed limitations, avoidance of severe weather conditions, etc.).

Operational limitations: Limitations, including flight limitations, that can be applied to the aeroplane operating conditions before dispatch (e.g., fuel, payload and Master Minimum Equipment List limitations).

Probabilistic terms: The probabilistic terms (probable, improbable, extremely improbable) used in this appendix are the same as those used in § 25.1309.

Failure condition: The term failure condition is the same as that used in § 25.1309, however this appendix applies only to system failure conditions that affect the structural performance of the aeroplane (e.g., system failure conditions that induce loads, change the response of the aeroplane to inputs such as gusts or pilot actions, or lower flutter margins).

L25.2. Effects of Systems on Structures.

- (a) **General.** The following criteria will be used in determining the influence of a system and its failure conditions on the aeroplane structure.
- (b) **System fully operative.** With the system fully operative, the following apply:
 - (1) Limit loads must be derived in all normal operating configurations of the system from all the limit conditions specified in Subpart C, taking into account any special behaviour of such a system or associated functions or any effect on the structural performance of the aeroplane that may occur up to the limit loads. In particular, any significant nonlinearity (rate of displacement of control surface, thresholds or any other system nonlinearities) must be accounted for in a realistic or conservative way when deriving limit loads from limit conditions.
 - (2) The aeroplane must meet the strength requirements of JAR 25 (Static strength, residual strength), using the specified factors to derive ultimate loads from the limit loads defined above.
The effect of non linearities must be investigated beyond limit conditions to ensure the behaviour of the system presents no anomaly compared to the behaviour below limit conditions. However, conditions beyond limit conditions need not be considered when it can be shown that the aeroplane has design features that will not allow it to exceed those limit conditions.
 - (3) The aeroplane must meet the aeroelastic stability requirements of § 25.629.
- (c) **System in the failure condition.** For any system failure condition not shown to be extremely improbable, the following apply:
 - (1) At the time of occurrence. Starting from 1-g level flight conditions, a realistic scenario, including pilot corrective actions, must be established to determine the loads occurring at the time of failure and immediately after failure.

- i. For static strength substantiation, these loads multiplied by an appropriate factor of safety that is related to the probability of occurrence of the failure are ultimate loads to be considered for design. The factor of safety (F.S.) is defined in Figure 1.

Figure 1

Factor of safety at the time of occurrence

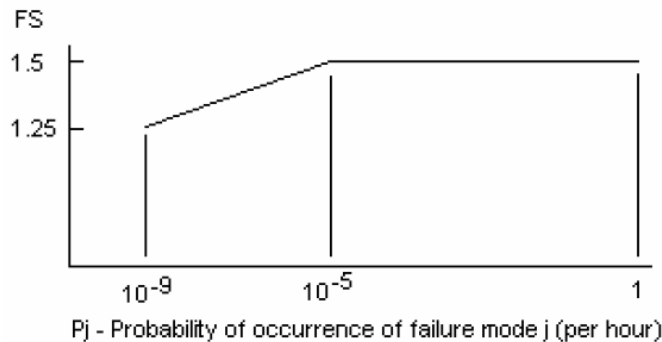

- ii. For residual strength substantiation, the aeroplane must be able to withstand two thirds of the ultimate loads defined in subparagraph (c)(1)(i). For pressurised cabins, these loads must be combined with the normal operating differential pressure.
- iii. Freedom from aeroelastic instability must be shown up to the speeds defined in § 25.629(b)(2). For failure conditions that result in speed increases beyond V_C/M_C , freedom from aeroelastic instability must be shown to increased speeds, so that the margins intended by § 25.629(b)(2) are maintained.
- iv. Failures of the system that result in forced structural vibrations (oscillatory failures) must not produce loads that could result in detrimental deformation of primary structure.
- (2) For the continuation of the flight. For the aeroplane, in the system failed state and considering any appropriate reconfiguration and flight limitations, the following apply:
- (i) The loads derived from the following conditions at speeds up to V_C/M_C , or the speed limitation prescribed for the remainder of the flight must be determined:
- the limit symmetrical manoeuvring conditions specified in § 25.331 and in § 25.345.
 - the limit gust and turbulence conditions specified in § 25.341 and in § 25.345.
 - the limit rolling conditions specified in § 25.349 and the limit unsymmetrical conditions specified in § 25.367 and § 25.427(b) and (c).
 - the limit yaw manoeuvring conditions specified in § 25.351.
 - the limit ground loading conditions specified in § 25.473 and § 25.491.
- (ii) For static strength substantiation, each part of the structure must be able to withstand the loads in subparagraph (2)(i) of this paragraph multiplied by a factor of safety depending on the probability of being in this failure state. The factor of safety is defined in Figure 2.

Figure 2

Factor of safety for continuation of flight

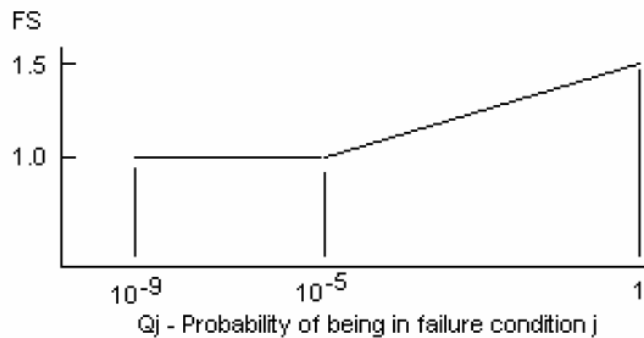

- $Q_j = (T_j)(P_j)$ where:
- T_j = Average time spent in failure condition j (in hours)
- P_j = Probability of occurrence of failure mode j (per hour)

Note: If P_j is greater than 10^{-3} , per flight hour then a 1.5 factor of safety must be applied to all limit load conditions specified in Subpart C.

- (iii) For residual strength substantiation, the aeroplane must be able to withstand two thirds of the ultimate loads defined in subparagraph (c) (2) (ii). For pressurised cabins, these loads must be combined with the normal operating differential pressure.
- (iv) If the loads induced by the failure condition have a significant effect on fatigue or damage tolerance then their effects must be taken into account.
- (v) Freedom from aeroelastic instability must be shown up to a speed determined from Figure 3. Flutter clearance speeds V' and V'' may be based on the speed limitation specified for the remainder of the flight using the margins defined by § 25.629(b).

Figure 3

Clearance speed

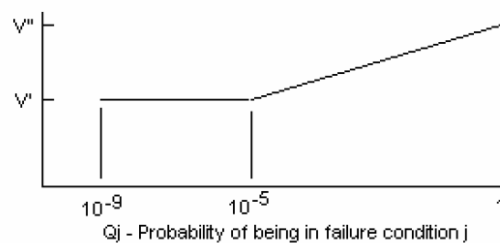

- V' = Clearance speed as defined by § 25.629(b)(2).
- V'' = Clearance speed as defined by § 25.629(b)(1).
- $Q_j = (T_j)(P_j)$ where:
- T_j = Average time spent in failure condition j (in hours)
- P_j = Probability of occurrence of failure mode j (per hour)

Note: If P_j is greater than 10^{-3} per flight hour, then the flutter clearance speed must not be less than V'' .

- (vi) Freedom from aeroelastic instability must also be shown up to V' in Figure 3 above, for any probable system failure condition combined with any damage required or selected for investigation by § 25.571(b).
- (3) Consideration of certain failure conditions may be required by other Sections of this Part regardless of calculated system reliability. Where analysis shows the probability of these failure conditions to be less than 10^{-9} , criteria other than those specified in this paragraph may be used for structural substantiation to show continued safe flight and landing.
- (d) **Failure indications.** For system failure detection and indication, the following apply:
- (1). The system must be checked for failure conditions, not extremely improbable, that degrade the structural capability below the level required by part 25 or significantly reduce the reliability of the remaining system. As far as reasonably practicable, the flight crew must be made aware of these failures before flight. Certain elements of the control system, such as mechanical and hydraulic components, may use special periodic inspections, and electronic components may use daily checks, in lieu of detection and indication systems to achieve the objective of this requirement. These certification maintenance requirements must be limited to components that are not readily detectable by normal detection and indication systems and where service history shows that inspections will provide an adequate level of safety.
- (2). The existence of any failure condition, not extremely improbable, during flight that could significantly affect the structural capability of the aeroplane and for which the associated reduction in airworthiness can be minimised by suitable flight limitations, must be signalled to the flightcrew.
- For example, failure conditions that result in a factor of safety between the aeroplane strength and the loads of Subpart C below 1.25, or flutter margins below V'' , must be signalled to the crew during flight.
- (e) **Dispatch with known failure conditions.** If the aeroplane is to be dispatched in a known system failure condition that affects structural performance, or affects the reliability of the remaining system to maintain structural performance, then the provisions of 25.302 must be met for the dispatched condition and for subsequent failures. Flight limitations and expected operational limitations may be taken into account in establishing Q_j as the combined probability of being in the dispatched failure condition and the subsequent failure condition for the safety margins in Figures 2 and 3. These limitations must be such that the probability of being in this combined failure state and then subsequently encountering limit load conditions is extremely improbable. No reduction in these safety margins is allowed if the subsequent system failure rate is greater than $1E-3$ per flight hour.

– END –

EQUIVALENT SAFETY FINDING and IM	C-12 ESF & IM: Vibration, Buffet and Aeroelastic Stability Requirements
APPLICABILITY:	A380
REQUIREMENTS:	JAR 25.251, 25.305, 25.629
ADVISORY MATERIAL:	N/A

BACKGROUND

The Vibration, buffet and aeroelastic stability requirements of NPA 25BCD-236 significantly differ from JAR 25 at Change 15.

In particular, NPA 25BCD-236 decreases the margin to be taken on the V_D/M_D versus altitude envelope which is to be shown to be free from aeroelastic instability in normal conditions, from 20 % to 15 %, compared to JAR 25 Change 15. On the other hand, NPA 25BCD-236 provides a more comprehensive set of requirements related to failures and malfunctions which could affect the aeroelastic stability.

The NPA 25BCD-236 has the intent of harmonising the JAR vibration, buffet and aeroelastic stability requirements with those of the FAR and ensures an equivalent level of safety to direct compliance to applicable JAR 25 change 15 requirements.

EQUIVALENT SAFETY FINDING

1. JAR 25.251 (a) and (b) are revised to read as follows:

JAR 25.251 Vibrating and buffeting.

- (a) The aeroplane must be demonstrated in flight to be free from any vibration and buffeting that would prevent continued safe flight in any likely operating condition.
- (b) Each part of the aeroplane must be demonstrated in flight to be free from excessive vibration under any appropriate speed and power conditions up to V_{DF}/M_{DF} . The maximum speeds shown must be used in establishing the operating limitations of the aeroplane in accordance with JAR 25.1505.

2. JAR 25.305 is revised by adding sub-paragraph (e) as follows :

- (e) The aeroplane must be designed to withstand any vibration and buffeting that might occur in any likely operating condition up to V_D/M_D , including stall and probable inadvertent excursions beyond the boundaries of the buffet onset envelope. This must be shown by analysis, flight tests, or other tests found necessary by the Authority.

3. JAR 25.427 is revised by adding a new sub-paragraph (d) as follows :

- (d) Unsymmetrical loading on the empennage arising from buffet conditions of JAR 25.305 (e) above must be taken into account.

4. JAR 25.629 is revised to read as follows:

JAR 25.629 Aeroelastic stability requirements.

- (a) *General.* The aeroelastic stability evaluations required under this paragraph include flutter, divergence, control reversal and any undue loss of stability and control as a result of structural deformation. The aeroelastic evaluation must include whirl modes associated with any propeller or rotating device that contributes significant dynamic forces. Compliance with this paragraph must be shown by analyses, tests, or some combination thereof as found necessary by the Authority (see ACJ 25.629).

- (b) *Aeroelastic stability envelopes.* The aeroplane must be designed to be free from aeroelastic instability for all configurations and design conditions within the aeroelastic stability envelopes as follows:
- (1) For normal conditions without failures, malfunctions, or adverse conditions, all combinations of altitudes and speeds encompassed by the V_D/M_D versus altitude envelope enlarged at all points by an increase of 15 percent in equivalent airspeed at constant Mach number and constant altitude. In addition, a proper margin of stability must exist at all speeds up to V_D/M_D and, there must be no large and rapid reduction in stability as V_D/M_D is approached. The enlarged envelope may be limited to Mach 1.0 when M_D is less than 1.0 at all design altitudes; and
 - (2) For the conditions described in JAR 25.629(d) below, for all approved altitudes, any airspeed up to the greater airspeed defined by:
 - (i) The V_D/M_D envelope determined by JAR 25.335(b); or,
 - (ii) An altitude-airspeed envelope defined by a 15 percent increase in equivalent airspeed above V_C at constant altitude, from sea level to the altitude of the intersection of $1.15 V_C$ with the extension of the constant cruise Mach number line, M_C , then a linear variation in equivalent airspeed to $M_C + 0.05$ at the altitude of the lowest V_C/M_C intersection; then, at higher altitudes, up to the maximum flight altitude, the boundary defined by a 0.05 Mach increase in M_C at constant altitude; and
 - (iii) Failure conditions of certain systems must be treated in accordance with JAR 25.302.
- (c) *Balance weights.* If balance weights are used, their effectiveness and strength, including supporting structure, must be substantiated.
- (d) *Failures, malfunctions, and adverse conditions.* The failures, malfunctions, and adverse conditions which must be considered in showing compliance with this paragraph are:
- (1) Any critical fuel loading conditions, not shown to be extremely improbable, which may result from mismanagement of fuel.
 - (2) Any failure in any flutter control system not shown to be extremely improbable.
 - (3) For aeroplanes not approved for operation in icing conditions, the maximum likely ice accumulation expected as a result of an inadvertent encounter.
 - (4) Failure of any single element of the structure supporting any engine, independently mounted propeller shaft, large auxiliary power unit, or large externally mounted aerodynamic body (such as an external fuel tank).
 - (5) For aeroplanes with engines that have propellers or large rotating devices capable of significant dynamic forces, any single failure of the engine structure that would reduce the rigidity of the rotational axis.
 - (6) The absence of aerodynamic or gyroscopic forces resulting from the most adverse combination of feathered propellers or other rotating devices capable of significant dynamic forces. In addition, the effect of a single feathered propeller or rotating device must be coupled with the failures of sub-paragraphs (d)(4) and (d)(5) of this paragraph.
 - (7) Any single propeller or rotating device capable of significant dynamic forces rotating at the highest likely overspeed.
 - (8) Any damage or failure condition, required or selected for investigation by JAR 25.571. The single structural failures described in sub-paragraphs (d)(4) and (d)(5) of this paragraph need not be considered in showing compliance with this paragraph if:
 - (i) The structural element could not fail due to discrete source damage resulting from the conditions described in JAR 25.571(e) and 25.903(d); and
 - (ii) A damage tolerance investigation in accordance with JAR 25.571(b) shows that the maximum extent of damage assumed for the purpose of residual strength evaluation does not involve complete failure of the structural element.

- (9) Any damage, failure or malfunction, considered under JAR 25.631, 25.671, 25.672, and 25.1309.
- (10) Any other combination of failures, malfunctions, or adverse conditions not shown to be extremely improbable.

(e) *Flight flutter testing.* Full scale flight flutter tests at speeds up to V_{DF}/M_{DF} must be conducted for new type designs and for modifications to a type design unless the modifications have been shown to have an insignificant effect on the aeroelastic stability. These tests must demonstrate that the aeroplane has a proper margin of damping at all speeds up to V_{DF}/M_{DF} , and that there is no large and rapid reduction in damping as V_{DF}/M_{DF} is approached. If a failure, malfunction, or adverse condition is simulated during flight test in showing compliance with sub-paragraph (d) of this paragraph, the maximum speed investigated need not exceed V_{FC}/M_{FC} if it is shown, by correlation of the flight test data with other test data or analyses, that the aeroplane is free from any aeroelastic instability at all speeds within the altitude-airspeed envelope described in sub-paragraph (b)(2) of this paragraph.

INTERPRETATIVE MATERIAL

The following ACJ is inserted :

ACJ 25.629

Aeroelastic stability requirements - Acceptable means of compliance

See JAR 25.629

1. *General.* The general requirement for demonstrating freedom from aeroelastic instability is contained in JAR 25.629, which also sets forth specific requirements for the investigation of these aeroelastic phenomena for various aeroplane configurations and flight conditions. Additionally, there are other conditions defined by the JAR paragraphs listed below to be investigated for aeroelastic stability to assure safe flight. Many of the conditions contained in this ACJ pertain only to the current version of JAR 25. Type design changes to aeroplanes certified to an earlier JAR 25 change must meet the certification basis established for the modified aeroplane.

JAR 25.251 - Vibration and buffeting

JAR 25.305 - Strength and deformation

JAR 25.335 - Design airspeeds

JAR 25.343 - Design fuel and oil loads

JAR 25.571 - Damage-tolerance and fatigue evaluation of structure

JAR 25.629 - Aeroelastic stability requirements

JAR 25.631 - Bird strike damage

JAR 25.671 - General (Control systems)

JAR 25.672 - Stability augmentation and automatic and power operated systems

JAR 25.1309 - Equipment, systems and installations

JAR 25.1329 - Automatic pilot system

JAR 25.1419 - Ice protection

2. *Aeroelastic Stability Envelope*

- 2.1. For nominal conditions without failures, malfunctions, or adverse conditions, freedom from aeroelastic instability is required to be shown for all combinations of airspeed and altitude encompassed by the design dive speed (V_D) and design dive Mach number (M_D) versus altitude envelope enlarged at all points by an increase of 15 percent in equivalent airspeed at both constant Mach number and constant altitude. Figure 1A represents a typical design envelope expanded to the required aeroelastic stability envelope. Note that

some required Mach number and airspeed combinations correspond to altitudes below standard sea level.

- 2.2. The aeroelastic stability envelope may be limited to a maximum Mach number of 1.0 when M_D is less than 1.0 and there is no large and rapid reduction in damping as M_D is approached.
- 2.3. Some configurations and conditions that are required to be investigated by JAR 25.629 and other JAR 25 regulations consist of failures, malfunctions or adverse conditions. Aeroelastic stability investigations of these conditions need to be carried out only within the design airspeed versus altitude envelope defined by:
- (i) the V_D/M_D envelope determined by JAR 25.335(b); or,
 - (ii) an altitude-airspeed envelope defined by a 15 percent increase in equivalent airspeed above V_C at constant altitude, from sea level up to the altitude of the intersection of $1.15 V_C$ with the extension of the constant cruise Mach number line, M_C , then a linear variation in equivalent airspeed to $M_C + .05$ at the altitude of the lowest V_C/M_C intersection; then at higher altitudes, up to the maximum flight altitude, the boundary defined by a .05 Mach increase in M_C at constant altitude.

Figure 1B shows the minimum aeroelastic stability envelope for fail-safe conditions, which is a composite of the highest speed at each altitude from either the V_D envelope or the constructed altitude airspeed envelope based on the defined V_C and M_C .

Fail-safe design speeds, other than the ones defined above, may be used for certain system failure conditions when specifically authorised by other rules or special conditions prescribed in the certification basis of the aeroplane.

FIGURE 1A. MINIMUM REQUIRED AEROELASTIC STABILITY MARGIN

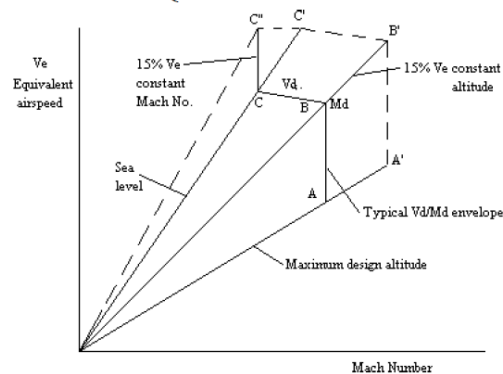
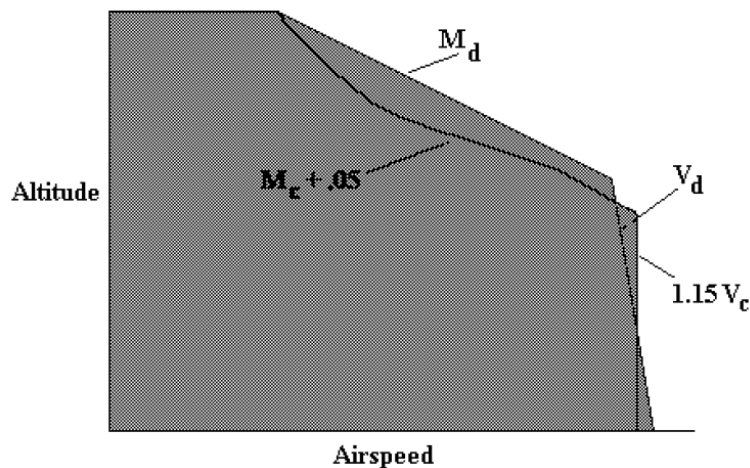

FIGURE 1B MINIMUM FAIL-SAFE CLEARANCE ENVELOPE



3. *Configurations and Conditions.* The following paragraphs provide a summary of the configurations and conditions to be investigated in demonstrating compliance with JAR 25. Specific design configurations may warrant additional considerations not discussed in this ACJ.

3.1. *Nominal Configurations and Conditions.* Nominal configurations and conditions of the aeroplane are those that are likely to exist in normal operation. Freedom from aeroelastic instability should be shown throughout the expanded clearance envelope described in paragraph 2.1 above for:

3.1.1. The range of fuel and payload combinations, including zero fuel in the wing, for which certification is requested.

3.1.2. Configurations with any likely ice mass accumulations on unprotected surfaces for aeroplanes approved for operation in icing conditions.

3.1.3. All normal combinations of autopilot, yaw damper, or other automatic flight control systems.

3.1.4. All possible engine settings and combinations of settings from idle power to maximum available thrust including the conditions of one engine stopped and windmilling, in order to address the influence of gyroscopic loads and thrust on aeroelastic stability.

3.2. *Failures, Malfunctions, and Adverse Conditions.* The following conditions should be investigated for aeroelastic instability within the fail-safe envelope defined in paragraph 2.3 above.

3.2.1. Any critical fuel loading conditions, not shown to be extremely improbable, which may result from mismanagement of fuel.

3.2.2. Any single failure in any flutter control system.

3.2.3. For aeroplanes not approved for operation in icing conditions, any likely ice accumulation expected as a result of an inadvertent encounter. For aeroplanes approved for operation in icing conditions, any likely ice accumulation expected as the result of any single failure in the de-icing system, or any combination of failures not shown to be extremely improbable.

3.2.4. Failure of any single element of the structure supporting any engine, independently mounted propeller shaft, large auxiliary power unit, or large externally mounted aerodynamic body (such as an external fuel tank).

3.2.5. For aeroplanes with engines that have propellers or large rotating devices capable of significant dynamic forces, any single failure of the engine structure that would reduce the rigidity of the rotational axis.

3.2.6. The absence of aerodynamic or gyroscopic forces resulting from the most adverse combination of feathered propellers or other rotating devices capable of significant dynamic forces. In addition, the effect of a single feathered propeller or rotating device must be coupled with the failures of paragraphs 3.2.4 and 3.2.5 above.

3.2.7. Any single propeller or rotating device capable of significant dynamic forces rotating at the highest likely overspeed.

3.2.8. Any damage or failure condition, required or selected for investigation by JAR 25.571. The single structural failures described in paragraphs 3.2.4 and 3.2.5 above need not be considered in showing compliance with this paragraph if;

- (A) The structural element could not fail due to discrete source damage resulting from the conditions described in JAR 25.571(e) and JAR 25.903(d); and
- (B) A damage tolerance investigation in accordance with JAR 25.571(b) shows that the maximum extent of damage assumed for the purpose of residual strength evaluation does not involve complete failure of the structural element.

3.2.9. Any damage, failure or malfunction, considered under JAR 25.631, 25.671, 25.672, and 25.1309. This includes the condition of two or more engines stopped or windmilling for the design range of fuel and payload combinations, including zero fuel.

3.2.10 Any other combination of failures, malfunctions, or adverse conditions not shown to be extremely improbable.

4. *Detail Design Requirements.*

4.1. Main surfaces, such as wings and stabilisers, should be designed to meet the aeroelastic stability criteria for nominal conditions and should be investigated for meeting fail-safe criteria by considering stiffness changes due to discrete damage or by reasonable parametric variations of design values.

4.2. Control surfaces, including tabs, should be investigated for nominal conditions and for failure modes that include single structural failures (such as actuator disconnects, hinge failures, or, in the case of aerodynamic balance panels, failed seals), single and dual hydraulic system failures and any other combination of failures not shown to be extremely improbable. Where other structural components contribute to the aeroelastic stability of the system, failures of those components should be considered for possible adverse effects.

4.3. Where aeroelastic stability relies on control system stiffness and/or damping, additional conditions should be considered. The actuation system should continuously provide, at least, the minimum stiffness or damping required for showing aeroelastic stability without regard to probability of occurrence for:

- (i) more than one engine stopped or windmilling,
- (ii) any discrete single failure resulting in a change of the structural modes of vibration (for example; a disconnect or failure of a mechanical element, or a structural failure of a hydraulic element, such as a hydraulic line, an actuator, a spool housing or a valve);
- (iii) any damage or failure conditions considered under JAR 25.571, 25.631 and 25.671.

The actuation system minimum requirements should also be continuously met after any combination of failures not shown to be extremely improbable (occurrence less than 10^{-9} per flight hour). However, certain combinations of failures, such as dual electric or dual hydraulic system failures, or any single failure in combination with any probable electric or hydraulic system failure (JAR 25.671), are not normally considered extremely improbable regardless of probability calculations. The reliability assessment should be part of the substantiation documentation. In practice, meeting the above conditions may involve design concepts such as the use of check valves and accumulators,

computerised pre-flight system checks and shortened inspection intervals to protect against undetected failures.

- 4.4. Consideration of free play may be incorporated as a variation in stiffness to assure adequate limits are established for wear of components such as control surface actuators, hinge bearings, and engine mounts in order to maintain aeroelastic stability margins.
 - 4.5. If balance weights are used on control surfaces, their effectiveness and strength, including that of their support structure, should be substantiated.
 - 4.6. The automatic flight control system should not interact with the airframe to produce aeroelastic instability. When analyses indicate possible adverse coupling, tests should be performed to determine the dynamic characteristics of actuation systems such as servo-boost, fully powered servo control systems, closed-loop aeroplane flight control systems, stability augmentation systems, and other related powered-control systems.
5. *Compliance.* Demonstration of compliance with aeroelastic stability requirements for an aircraft configuration may be shown by analyses, tests, or some combination thereof. In most instances, analyses are required to determine aeroelastic stability margins for normal operations, as well as for possible failure conditions. Wind tunnel flutter model tests, where applicable, may be used to supplement flutter analyses. Ground testing may be used to collect stiffness or modal data for the aircraft or components. Flight testing may be used to demonstrate compliance of the aircraft design throughout the design speed envelope.
- 5.1. Analytical Investigations. Analyses should normally be used to investigate the aeroelastic stability of the aircraft throughout its design flight envelope and as expanded by the required speed margins. Analyses are used to evaluate aeroelastic stability sensitive parameters such as aerodynamic coefficients, stiffness and mass distributions, control surface balance requirements, fuel management schedules, engine/store locations, and control system characteristics. The sensitivity of most critical parameters may be determined analytically by varying the parameters from nominal. These investigations are an effective way to account for the operating conditions and possible failure modes which may have an effect on aeroelastic stability margins, and to account for uncertainties in the values of parameters and expected variations due to in-service wear or failure conditions.
 - 5.1.1. Analytical Modelling. The following paragraphs discuss acceptable, but not the only, methods and forms of modelling aircraft configurations and/or components for purposes of aeroelastic stability analysis. The types of investigations generally encountered in the course of aircraft aeroelastic stability substantiation are also discussed. The basic elements to be modelled in aeroelastic stability analyses are the elastic, inertial, and aerodynamic characteristics of the system. The degree of complexity required in the modelling, and the degree to which other characteristics need to be included in the modelling, depend upon the system complexity.
 - 5.1.1.1. *Structural Modelling.* Most forms of structural modelling can be classified into two main categories: (1) modelling using a lumped mass beam, and (2) finite element modelling. Regardless of the approach taken for structural modelling, a minimum acceptable level of sophistication, consistent with configuration complexity, is necessary to satisfactorily represent the critical modes of deformation of the primary structure and control surfaces. The model should reflect the support structure for the attachment of control surface actuators, flutter dampers, and any other elements for which stiffness is important in prevention of aeroelastic instability. Wing-pylon

mounted engines are often significant to aeroelastic stability and warrant particular attention in the modelling of the pylon, and pylon-engine and pylon-wing interfaces. The model should include the effects of cut-outs, doors, and other structural features which may tend to affect the resulting structural effectiveness. Reduced stiffness should be considered in the modelling of aircraft structural components which may exhibit some change in stiffness under limit design flight conditions. Structural models include mass distributions as well as representations of stiffness and possibly damping characteristics. Results from the models should be compared to test data, such as that obtained from ground vibration tests, in order to determine the accuracy of the model and its applicability to the aeroelastic stability investigation.

5.1.1.2. *Aerodynamic Modelling.*

- (a) Aerodynamic modelling for aeroelastic stability requires the use of unsteady, two-dimensional strip or three-dimensional panel theory methods for incompressible or compressible flow. The choice of the appropriate technique depends on the complexity of the dynamic structural motion of the surfaces under investigation and the flight speed envelope of the aircraft. Aerodynamic modelling should be supported by tests or previous experience with applications to similar configurations.
- (b) Main and control surface aerodynamic data are commonly adjusted by weighting factors in the aeroelastic stability solutions. The weighting factors for steady flow ($k=0$) are usually obtained by comparing wind tunnel test results with theoretical data. Special attention should be given to control surface aerodynamics because viscous and other effects may require more extensive adjustments to theoretical coefficients. Main surface aerodynamic loading due to control surface deflection should be considered.*

5.1.2. *Types of Analyses.*

5.1.2.1. Oscillatory (flutter) and non-oscillatory (divergence and control reversal) aeroelastic instabilities should be analysed to show compliance with JAR 25.629

5.1.2.2. The flutter analysis methods most extensively used involve modal analysis with unsteady aerodynamic forces derived from various two- and three-dimensional theories. These methods are generally for linear systems. Analyses involving control system characteristics should include equations describing system control laws in addition to the equations describing the structural modes.

5.1.2.3. Aeroplane lifting surface divergence analyses should include all appropriate rigid body mode degrees-of-freedom since divergence may occur for a structural mode or the short period mode.

5.1.2.4. Loss of control effectiveness (control reversal) due to the effects of elastic deformations should be investigated. Analyses should include the inertial, elastic, and aerodynamic forces resulting from a control surface deflection.

5.1.3 *Damping Requirements.*

5.1.3.1. There is no intent in this ACJ to define a flight test level of acceptable minimum damping.

5.1.3.2. Flutter analyses results are usually presented graphically in the form of frequency versus velocity (V-f, Figure 2) and damping versus velocity (V-g, Figures 3 and 4) curves for each root of the flutter solution.

5.1.3.3. Figure 3 details one common method for showing compliance with the requirement for a proper margin of damping. It is based on the assumption that the structural damping available is 0.03 (1.5% critical viscous damping) and is the same for all modes as depicted by the V-g curves shown in Figure 3. No significant mode, such as curves (2) or (4), should cross the $g=0$ line below V_D or the $g=0.03$ line below $1.15 V_D$. An exception may be a mode exhibiting damping characteristics similar to curve (1) in Figure 3, which is not critical for flutter. A divergence mode, as illustrated by curve (3) where the frequency approaches zero, should have a divergence velocity not less than $1.15 V_D$.

5.1.3.4. Figure 4 shows another common method of presenting the flutter analysis results and defining the structural damping requirements. An appropriate amount of structural damping for each mode is entered into the analysis prior to the flutter solution. The amount of structural damping used should be supported by measurements taken during full scale tests. This results in modes offset from the $g=0$ line at zero airspeed and, in some cases, flutter solutions different from those obtained with no structural damping. The similarity in the curves of Figures 3 and 4 are only for simplifying this example. The minimum acceptable damping line applied to the analytical results as shown in Figure 4 corresponds to 0.03 or the modal damping available at zero airspeed for the particular mode of interest, whichever is less, but in no case less than 0.02. No significant mode should cross this line below V_D or the $g=0$ line below $1.15 V_D$.

5.1.3.5. For analysis of failures, malfunctions or adverse conditions being investigated, the minimum acceptable damping level obtained analytically would be determined by use of either method above, but with a substitution of V_C for V_D and the fail-safe envelope speed at the analysis altitude as determined by paragraph 2.3 above.

FIGURE 2. FREQUENCY VERSUS VELOCITY

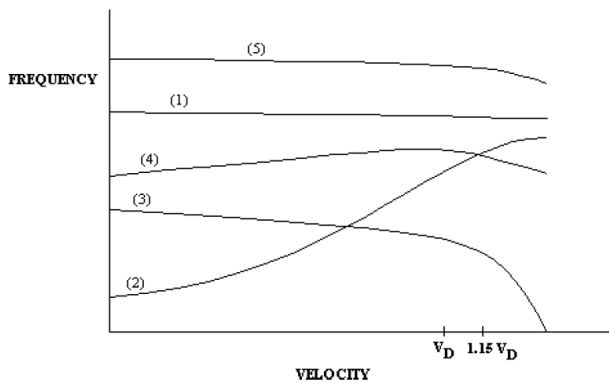

FIGURE 3. DAMPING VERSUS VELOCITY - Method 1

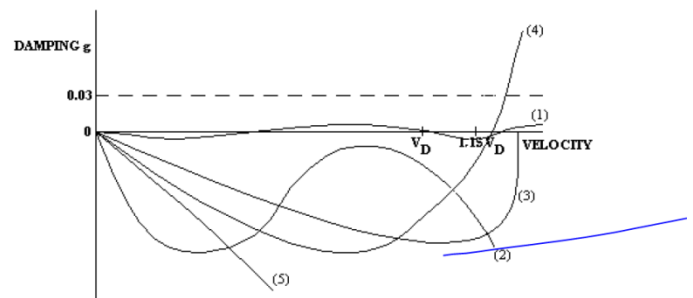
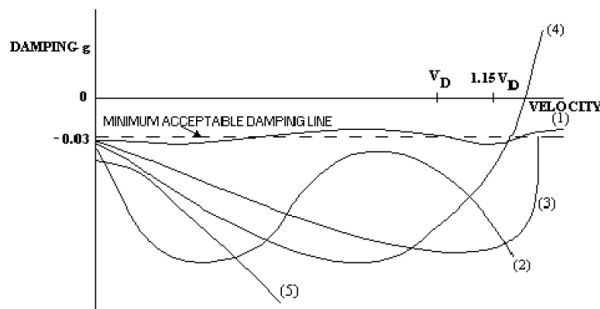

FIGURE 4. DAMPING VERSUS VELOCITY - Method 2



5.1.4. *Analysis Considerations* Airframe aeroelastic stability analyses may be used to verify the design with respect to the structural stiffness, mass, fuel (including in-flight fuel management), automatic flight control system characteristics, and altitude and Mach number variations within the design flight envelope. The complete aeroplane should be considered as composed of lifting surfaces and bodies, including all primary control surfaces which can interact with the lifting surfaces to affect flutter stability. Control surface flutter can occur in any speed regime and has historically been the most common form of flutter. Lifting surface flutter is more likely to occur at high dynamic pressure and at high subsonic and transonic Mach numbers. Analyses are necessary to establish the mass balance and/or stiffness and redundancy requirements for the control surfaces and supporting structure and to determine the basic surface flutter trends. The analyses may be used to determine the sensitivity of the nominal aircraft design to aerodynamic, mass, and stiffness variations. Sources of stiffness variation may include the effects of skin buckling at limit load factor, air entrapment in hydraulic actuators, expected levels of in-service free play, and control system components which may include elements with non-linear stiffness. Mass variations include the effects of fuel density and distribution, control surface repairs and painting, and water and ice accumulation.

5.1.4.1. *Control Surfaces* Control surface aeroelastic stability analyses should include control surface rotation, tab rotation (if applicable), significant modes of the aeroplane, control surface torsional degrees-of-freedom, and control surface bending (if applicable). Analyses of aeroplanes with tabs should include tab rotation that is both independent and related to the parent control surface. Control surface rotation frequencies should be varied about nominal values as appropriate for the condition. The control surfaces should be analysed as completely free in rotation unless it can be shown that this condition is extremely improbable. All conditions between stick-free and stick-fixed should be investigated. Freeplay effects should be incorporated to account for any influence of in-service wear on flutter margins. The aerodynamic coefficients of the control surface and tab used in the aeroelastic stability analysis should be adjusted to match experimental values at zero frequency. Once the analysis has been conducted with the nominal, experimentally adjusted values of hinge moment coefficients, the analysis should be conducted with parametric variations of these coefficients and other parameters subject to variability. If aeroelastic stability margins are found to be sensitive to these parameters, then additional verification in the form of model or flight tests may be required.

5.1.4.2. *Mass Balance*

(a) The magnitude and spanwise location of control surface balance weights may be evaluated by analysis and/or wind tunnel flutter model tests. If the control surface torsional degrees of freedom are not included in the analysis, then adequate separation must be maintained between the frequency of the control surface first torsion mode and the flutter mode.

(b) Control surface unbalance tolerances should be specified to provide for repair and painting. The accumulation of water, ice, and/or dirt in or near the trailing edge of a control surface should be avoided. Free play between the balance weight, the support arm, and the control surface must not be allowed. Control surface mass properties (weight and static unbalance) should be confirmed by measurement before ground vibration testing.

(c) The balance weights and their supporting structure should be substantiated for the extreme load factors expected throughout the design flight envelope. If the absence of a rational investigation, the following limit accelerations, applied through the balance weight centre of gravity should be used.

100g normal to the plane of the surface
30g parallel to the hinge line
30g in the plane of the surface and perpendicular to the hinge line

5.1.4.3. *Passive Flutter Dampers* Control surface passive flutter dampers may be used to prevent flutter in the event of failure of some element of the control surface actuation system or to prevent control surface buzz. Flutter analyses and/or flutter model wind tunnel tests may be used to verify adequate damping. Damper support structure flexibility should be included in the determination of adequacy of damping at the flutter frequencies. Any single damper failure should be considered.

Combinations of multiple damper failures should be examined when not shown to be extremely improbable. The combined free play of the damper and supporting elements between the control surface and fixed surfaces should be considered. Provisions for in-service checks of damper integrity should be considered. Refer to paragraph 4.3 above for conditions to consider where a control surface actuator is switched to the role of an active or passive damping element of the flight control system.

5.1.4.4. *Intersecting Lifting Surfaces* Intersecting lifting surface aeroelastic stability characteristics are more difficult to predict accurately than the characteristics of planar surfaces such as wings. This is due to difficulties both in correctly predicting vibration modal characteristics and in assessing those aerodynamic effects which may be of second order importance on planar surfaces, but are significant for intersecting surfaces. Proper representation of modal deflections and unsteady aerodynamic coupling terms between surfaces is essential in assessing the aeroelastic stability characteristics. The in-plane forces and motions of one or the other of the intersecting surfaces may have a strong effect on aeroelastic stability; therefore, the analysis should include the effects of steady flight forces and elastic deformations on the in-plane effects.

5.1.4.5. *Ice Accumulation* Aeroelastic stability analysis should use the mass distributions derived from any likely ice accumulations. The ice accumulation determination can take account of the ability to detect the ice and the time required to leave the icing condition. The analyses need not consider the aerodynamic effects of ice shapes.

5.1.4.6. *Whirl Flutter*

(a) The evaluation of the aeroelastic stability should include investigations of any significant elastic, inertial, and aerodynamic forces, including those associated with rotations and displacements in the plane of any turbofan or propeller, including propeller or fan blade aerodynamics, powerplant flexibilities, powerplant mounting characteristics, and gyroscopic coupling.

(b) Failure conditions are usually significant for whirl instabilities. Engine mount, engine gear box support, or shaft failures which result in a node line shift for propeller hub pitching or yawing motion are especially significant.

(c) A wind tunnel test with a component flutter model, representing the engine/propeller system and its support system along with correlative vibration and flutter analyses of the flutter model, may be used to demonstrate adequate stability of the nominal design and failed conditions.

5.1.4.7. *Automatic Control Systems* Aeroelastic stability analyses of the basic configuration should include simulation of any control system for which interaction may exist between the sensing elements and the structural modes. Where structural/control system feedback is a potential problem the effects of servo-actuator

characteristics and the effects of local deformation of the servo mount on the feedback sensor output should be included in the analysis. The effect of control system failures on the aeroplane aeroelastic stability characteristics should be investigated. Failures which significantly affect the system gain and/or phase and are not shown to be extremely improbable should be analysed.

5.2. Testing the aeroelastic stability certification test programme may consist of ground tests, flutter model tests, and flight flutter tests. Ground tests may be used for assessment of component stiffness and for determining the vibration modal characteristics of aircraft components and the complete airframe. Flutter model testing may be used to establish flutter trends and validate aeroelastic stability boundaries in areas where unsteady aerodynamic calculations require confirmation. Full scale flight flutter testing provides final verification of aeroelastic stability. The results of any of these tests may be used to provide substantiation data, to verify and improve analytical modelling procedures and data, and to identify potential or previously undefined problem areas.

5.2.1. *Structural Component Tests.* Stiffness tests or ground vibration tests of structural components are desirable to confirm analytically predicted characteristics and are necessary where stiffness calculations cannot accurately predict these characteristics. Components should be mounted so that the mounting characteristics are well defined or readily measurable.

5.2.2. *Control System Component Tests* When reliance is placed on stiffness or damping to prevent aeroelastic instability, the following control system tests should be conducted. If the tests are performed off the aeroplane the test fixtures should reflect local attachment flexibility.

- (i) Actuators for primary flight control surfaces and flutter dampers should be tested with their supporting structure. These tests are to determine the actuator/support structure stiffness for nominal design and failure conditions considered in the fail-safe analysis.
- (ii) Flutter damper tests should be conducted to verify the impedance of damper and support structure. Satisfactory installed damper effectiveness at the potential flutter frequencies should, however, be assured. The results of these tests can be used to determine a suitable, inservice maintenance schedule and replacement life of the damper. The effects of allowable inservice free play should be measured.

5.2.3. *Ground vibration Tests*

5.2.3.1. Ground vibration tests (GVT) or modal response tests are normally conducted on the complete conforming aeroplane. A GVT may be used to check the mathematical structural model. Alternatively, the use of measured modal data alone in aeroelastic stability analyses, instead of analytical modal data modified to match test data, may be acceptable provided the accuracy and completeness of the measured modal data is established. Whenever structural modifications or inertia changes are made to a previously certified design or a GVT validated model of the basic aeroplane, a GVT may not be necessary if these changes are shown not to affect the aeroelastic stability characteristics.

5.2.3.2. The aeroplane is best supported such that the suspended aeroplane rigid body modes are effectively uncoupled from the elastic modes of the aeroplane. Alternatively, a suspension method may be used that couples with the elastic aeroplane provided that the suspension can be analytically decoupled from the aeroplane structure in the vibration analysis. The former suspension criterion is

preferred for all ground vibration tests and is necessary in the absence of vibration analysis.

5.2.3.3. The excitation method needs to have sufficient force output and frequency range to adequately excite all significant resonant modes. The effective mass and stiffness of the exciter and attachment hardware should not distort modal response. More than one exciter or exciter location may be necessary to insure that all significant modes are identified. Multiple exciter input may be necessary on structures with significant internal damping to avoid low response levels and phase shifts at points on the structure distant from the point of excitation. Excitation may be sinusoidal, random, pseudorandom, transient, or other short duration, non stationary means. For small surfaces the effect of test sensor mass on response frequency should be taken into consideration when analysing the test results.

5.2.3.4. The minimum modal response measurement should consist of acceleration (or velocity) measurements and relative phasing at a sufficient number of points on the aeroplane structure to accurately describe the response or mode shapes of all significant structural modes. In addition, the structural damping of each mode should be determined.

5.2.4. *Flutter Model Tests.*

5.2.4.1. Dynamically similar flutter models may be tested in the wind tunnel to augment the flutter analysis. Flutter model testing can substantiate the flutter margins directly or indirectly by validating analysis data or methods. Some aspects of flutter analysis may require more extensive validation than others, for example control surface aerodynamics, T-tails and other configurations with aerodynamic interaction and compressibility effects. Flutter testing may additionally be useful to test configurations that are impractical to verify in flight test., such as fail-safe conditions or extensive store configurations.

In any such testing, the mounting of the model and the associated analysis should be appropriate and consistent with the study being performed.

5.2.4.2. Direct substantiation of the flutter margin (clearance testing) implies a high degree of dynamic similitude. Such a test may be used to augment an analysis and show a configuration flutter free throughout the expanded design envelope. All the physical parameters which have been determined to be significant for flutter response should be appropriately scaled. These will include elastic and inertia properties, geometric properties and dynamic pressure. If transonic effects are important, the Mach number should be maintained.

5.2.4.3. Validation of analysis methods is another appropriate use of wind tunnel flutter testing. When the validity of a method is uncertain, correlation of wind tunnel flutter testing results with a corresponding analysis may increase confidence in the use of the analytical tool for certification analysis. A methods validation test should simulate conditions, scaling and geometry appropriate for the intended use of the analytical method.

5.2.4.4. Trend studies are an important use of wind tunnel flutter testing. Parametric studies can be used to establish trends for control system balance and stiffness, fuel and payload variations, structural compliances and configuration variations. The set of physical parameters requiring similitude may not be as extensive to study parametric trends as is required for clearance testing. For example, an exact match of the Mach number may not be required to track the effects of payload variations on a transonic aeroplane.

5.2.5. Flight Flutter Tests

5.2.5.1 Full scale flight flutter testing of an aeroplane configuration to V_{DF}/M_{DF} is a necessary part of the flutter substantiation. An exception may be made when aerodynamic, mass, or stiffness changes to a certified aeroplane are minor, and analysis or ground tests show a negligible effect on flutter or vibration characteristics. If a failure, malfunction, or adverse condition is simulated during a flight test, the maximum speed investigated need not exceed V_{FC}/M_{FC} if it is shown, by correlation of the flight test data with other test data or analyses, that the requirements of JAR 25.629(b)(2) are met.

5.2.5.2. Aeroplane configurations and control system configurations should be selected for flight test based on analyses and, when available, model test results. Sufficient test conditions should be performed to demonstrate aeroelastic stability throughout the entire flight envelope for the selected configurations.

5.2.5.3. Flight flutter testing requires excitation sufficient to excite the modes shown by analysis to be the most likely to couple for flutter. Excitation methods may include control surface motions or internal moving mass or external aerodynamic exciters or flight turbulence. The method of excitation must be appropriate for the modal response frequency being investigated. The effect of the excitation system itself on the aeroplane flutter characteristics should be determined prior to flight testing.

5.2.5.4. Measurement of the response at selected locations on the structure should be made in order to determine the response amplitude, damping and frequency in the critical modes at each test airspeed. It is desirable to monitor the response amplitude, frequency and damping change as V_{DF}/M_{DF} is approached. In demonstrating that there is no large and rapid damping reduction as V_{DF}/M_{DF} is approached, an endeavour should be made to identify a clear trend of damping versus speed. If this is not possible, then sufficient test points should be undertaken to achieve a satisfactory level of confidence that there is no evidence of an adverse trend.

5.2.5.5. An evaluation of phenomena not presently amenable to analyses, such as shock effects, buffet response levels, vibration levels, and control surface buzz, should also be made during flight testing.

– END –

SPECIAL CONDITION and IM:	C-13 SC & IM: Design Manoeuvre requirement
APPLICABILITY:	A380
REQUIREMENTS:	25.331(c), 25.349 (a), 25.351
ADVISORY MATERIAL:	N/A

BACKGROUND

Existing requirements for design manoeuvres need to be modified because they are not adequate for an aircraft with electronic flight controls.

This A380 CRI establishes a Special Condition to adjust the current JAR 25 manoeuvre requirements (25.349 (a), 25.351) so as to take into account an aircraft with electronic flight controls. This is similar to the situation found on previous Airbus aircraft, except for the compliance with JAR 25.331 (c) requirement which is adequately covered by the paragraph 25.331 (c) (2) (iv) from the A380 Equivalent Safety Finding “Checked Pitching Manoeuvre Loads” (refer to the A380 CRI C-19).

The following Special Condition, also existing on Airbus SA and LR family, allow adapt JAR 25 requirements to technology used on Airbus aircraft.

SPECIAL CONDITION

1. Modify JAR 25.349 (a) to read:

- a) Manoeuvring: the following conditions, speeds and cockpit roll control motions (except as the motions may be limited by pilot effort) must be considered in combination with an aeroplane load factor of zero and the two-thirds of limit positive manoeuvring load factor. In determining the resulting control surface deflections the torsional flexibility of the wing must be considered in accordance with JAR 25.301 (b) :
 - (1) Conditions corresponding to maximum steady rolling velocities and conditions corresponding to maximum angular accelerations must be investigated. For the angular acceleration conditions zero rolling velocity may be assumed in the absence of a rational time history investigation of the manoeuvre.
 - (2) At V_A , movement of the cockpit roll control up to the limit is assumed. The position of the cockpit roll control must be maintained until a steady roll rate is achieved and then must be returned suddenly to the neutral position.
 - (3) At V_C , the cockpit roll control must be moved suddenly and maintained so as to achieve a roll rate not less than that obtained in sub-paragraph (2) of this paragraph.
 - (4) At V_D , the cockpit roll control must be moved suddenly and maintained so as to achieve a roll rate not less than one third of that obtained in sub-paragraph (2) of this paragraph (a).
 - (5) It must be established that manoeuvre loads induced by the system itself (i.e. abrupt changes in orders made possible by electrical rather than mechanical combination of different inputs) are acceptably accounted for.

2. Add a new subparagraph (e) to JAR 25.351 as follows:

JAR 25.351 (e)

It must be established that manoeuvre loads induced by the system itself (i.e. abrupt changes in orders made possible by electrical rather than mechanical combination of different inputs) are acceptably accounted for.

INTERPRETATIVE MATERIAL

The rolling manoeuvre of JAR 25.349 will be considered in the following manner:

- The aircraft is considered to be initially in a wings level attitude corresponding to a symmetrical pull-up or push over, over the range of normal acceleration from zero to two-thirds of the positive limit manoeuvring load factor.

(2) At V_A a sudden movement of the cockpit roll control up to the limits is assumed. The cockpit roll control shall be maintained until steady roll rate is achieved and then be returned suddenly to the neutral position.

(3) At V_C the cockpit control shall be moved suddenly and maintained so that a roll rate not less than that achieved in subparagraph (2) is achieved. The return of cockpit control is initiated suddenly when steady roll rate is reached.

(4) At V_D the cockpit control shall be moved suddenly and maintained so that a roll rate not less than one third of that in subparagraph (2) is achieved.

This is considered with:

- yaw control held steady
- corrective yaw control action to reduce sideslip as far as possible.

In addition the physical limitations of the aircraft, such as control stops position, maximum power and displacement rate of the servo controls, control law limiters, may be taken into account.

– END –

EQUIVALENT SAFETY FINDING and IM	C-14 ESF & IM: Proof of structure
APPLICABILITY:	A380
REQUIREMENTS:	JAR 25.307(a)
ADVISORY MATERIAL:	ACJ 25.307

BACKGROUND

Airbus has requested an Equivalent Safety Finding to JAR 25.307 as interpreted with current ACJ 25.307 at change 15 and proposes to show compliance to JAR 25.307 using the harmonised position between JAA and FAA as established within the ARAC Loads and Dynamics Harmonisation Working Group.

The list of materials is contained in P-NPA 25C-290 - Proof of structure, which is based on a text accepted by the JAA / FAA General Structure Harmonisation Working Group, in their March 1998 meeting.

The background justification for the equivalent safety finding is contained in the preamble of draft PNPA 25C-290 issue 1 dated 11 December 1997 already applied for A340-500/-600 certification and is intended to achieve common requirements and language between the proof of structure requirements of JAR-25 and FAR 25.

EQUIVALENT SAFETY FINDING

Amend JAR 25.307 as follows:

JAR 25.307 Proof of structure (See ACJ 25.307)

- (a) Compliance with the strength and deformation requirements of this Subpart must be shown for each critical loading condition. Structural analysis may be used only if the structure conforms to that for which experience has shown this method to be reliable. In other cases, substantiating tests must be made that are sufficient to verify structural behaviour up to the load levels required by JAR 25.305. Where it is justified, these test load levels may be reduced.
- (b) ***
- (c) ***
- (d) ***

INTERPRETATIVE MATERIAL

The following are acceptable means of compliance associated to ESF C-14.

Amend ACJ 25.307 as follows:

ACJ 25.307

Proof of Structure (Interpretative Material)

See JAR 25.307

1. Purpose

This ACJ establishes methods of compliance with JAR 25.307, which specifies the requirements for Proof of Structure. Other compliance methods may be used if approved by the Authority.

2. Definitions

- 2.1. Detail. A structural element of a more complex structural member (e.g. joints, splices, stringers, stringer run-outs, or access holes).
- 2.2. Sub Component. A major three-dimensional structure which can provide complete structural representation of a section of the full structure (e.g., stub-box, section of a spar, wing panel, wing rib, body panel, or frames).
- 2.3. Component. A major section of the airframe structure (e.g., wing, body, fin, horizontal stabiliser) which can be tested as a complete unit to qualify the structure.
- 2.4. Full Scale. Dimensions of test article are the same as design; fully representative test specimen (not necessarily complete airframe).
- 2.5. New Structure. Structure for which behaviour is not adequately predicted by analysis supported by previous test evidence. Structure that utilises significantly different structural design concepts such as details, geometry, structural arrangements, and load paths or materials from previously tested designs.
- 2.6. Similar New Structure. Structure that utilises similar or comparable structural design concepts such as details, geometry, structural arrangements, and load paths concepts and materials to an existing tested design.
- 2.7. Derivative/Similar Structure. Structure that uses structural design concepts such as details, geometry, structural arrangements, and load paths, stress levels and materials that are nearly identical to those on which the analytical methods have been validated.

3. Introduction

As required by subparagraph (a) of JAR 25.307, the structure must be shown to comply with the strength and deformation requirements of Subpart C of JAR-25. This means that the structure must :

- (a) be able to support limit loads without detrimental permanent deformation, and:
- (b) be able to support ultimate loads without failure.

This implies the need of a comprehensive assessment of the external loads (addressed by JAR 25.301), the resulting internal strains and stresses, and the structural allowables.

JAR 25.307 requires compliance for each critical loading condition. Compliance can be shown by analysis supported by previous test evidence, analysis supported by new test evidence or by test only. As compliance by test only is impractical in most cases, a large portion of the substantiating data will be based on analysis.

There are a number of standard engineering methods and formulas which are known to produce acceptable, often conservative results especially for structures where load paths are well defined. Those standard methods and formulas, applied with a good understanding of their limitations, are considered reliable analyses when showing compliance with JAR 25.307. Conservative assumptions may be considered in assessing whether or not an analysis may be accepted without test substantiation.

The application of methods such as Finite Element Method or engineering formulas to complex structures in modern aircraft is considered reliable only when validated by full scale tests (ground and/or flight tests). The applicant's experience in the utilisation of such methods should be considered.

4. Classification of structure

(a) The applicant should classify the structure into one of the following three categories:

- New Structure
- Similar New Structure
- Derivative/Similar Structure

(b) The applicant should provide justification for classifications other than New Structure.

Elements that should be considered are :

- (i) The accuracy/conservatism of the analytical methods, and
- (ii) Comparison of the structure under investigation with previously tested structure.

Considerations should include, but are not limited to the following:

- external loads (bending moment, shear, torque , etc.);
- internal loads (strains, stresses, etc.);
- structural design concepts such as details, geometry, structural arrangements,
- load paths ;
- materials ;
- test experience (load levels achieved, lessons learned);
- deflections ;
- deformations ;
- extent of extrapolation from test stress levels.

5. Need and Extent of Testing

The following factors should be considered in deciding the need for and the extent of testing including the load levels to be achieved:

- (a) The classification of the structure;
- (b) The consequence of failure of the structure in terms of the overall integrity of the aeroplane.

The confidence that can be attached to the applicant's overall experience in analysing, designing, and testing certain types of aeroplanes should be considered in deciding the extent of testing. Relevant service experience may be included in this evaluation.

6. Certification Approaches

The following certification approaches may be selected:

(a) *Analysis, supported by new strength testing of the structure to limit and ultimate load.*

This is typically the case for New Structure.

Substantiation of the strength and deformation requirements up to limit and ultimate loads normally requires testing of sub-components, full scale components or full scale tests of assembled components (such as a nearly complete airframe). The entire test program should be considered in detail to assure the requirements for strength and deformation can be met up to limit load levels as well as ultimate load levels.

Sufficient limit load test conditions should be performed to verify that the structure meets the deformation requirements of JAR 25.305(a) and to provide validation of internal load distribution and analysis predictions for all critical loading conditions.

Because ultimate load tests often result in significant permanent deformation, choices will have to be made with respect to the load conditions applied. This is usually based on the number of test specimens available, the analytical static strength margins of safety of the structure and the range of supporting detail or sub-component tests. An envelope approach may be taken, where a combination of different load cases is applied, each one critical for a different section of the structure.

These limit and ultimate load tests may be supported by detail and sub-component tests that verify the design allowables (tension, shear, compression) of the structure and often provide some degree of validation for ultimate strength.

- (b) *Analysis validated by previous test evidence and supported with additional limited testing.* This is typically the case for Similar New Structure.

The extent of additional limited testing (number of specimens, load levels, etc.) will depend upon the degree of change, relative to the elements of 4(b)(i) and (ii).

For example, if the changes to an existing design and analysis necessitate extensive changes to an existing test-validated finite element model (e.g. different rib spacing) additional testing may be needed. Previous test can be relied upon whenever practical.

These additional limited tests may be further supported by detail and sub-component tests that verify the design allowables (tension, shear, compression) of the structure and often provide some degree of validation for ultimate strength.

- (c) *Analysis, supported by previous test evidence.* This is typically the case for Derivative/Similar Structure.

The applicant should provide justification for this approach by demonstrating how the previous static test evidence validates the analysis and supports showing compliance for the structure under investigation. Elements that need to be considered are those defined in 4(b)(i) and (ii).

For example if the changes to the existing design and test-validated analysis are evaluated to assure they are relatively minor and the effects of the changes are well understood the original tests may provide sufficient validation of the analysis and further testing may not be necessary. For example, if a weight increase results in higher loads along with a corresponding increase in some of the element thickness and fastener sizes, and materials and geometry (overall configuration, spacing of structural members, etc.) remain generally the same, the revised analysis could be considered reliable based on the previous validation.

- (d) *Test only.*

Sometimes no reliable analytical method exists, and testing must be used to show compliance with the strength and deformation requirements. In other cases an applicant may elect to show compliance solely by tests even if there are acceptable analytical methods. In either case, testing by itself can be used to show compliance with the strength and deformation requirements of Subpart C. In such cases, the test load conditions should be selected to assure all critical design loads are encompassed.

If tests only are used to show compliance with the strength and deformation requirements for single load path structure which carries flight loads (including pressurisation loads), the test loads must be increased to account for variability in material properties, as required by JAR 25.307(d). In lieu of a rational analysis, for metallic materials, a factor of 1.15 applied to the limit and ultimate flight loads may be used. If the structure has multiple load paths, no material correction factor is required.

7. *Interpretation of Data*

The interpretation of the substantiation analysis and test data requires an extensive review of:

- the representativeness of the loading ;
- the instrumentation data ;
- comparisons with analytical methods ;
- representativeness of the test article(s) ;
- test set-up (fixture, load introductions) ;
- load levels and conditions tested ;
- test results.

Testing is used to validate analytical methods except when showing compliance by test only. If the test results do not correlate with the analysis, the reasons should be identified and appropriate action taken. This should be accomplished whether or not a test article fails below ultimate load.

Should a failure occur below ultimate load, an investigation by the applicant should be conducted to reveal the cause of this failure. This investigation should include a review of the test specimen and loads, analytical loads, and the structural analysis. This may lead to adjustment in analysis/modelling techniques and/or part redesign and may result in the need for additional testing. The need for additional testing to ensure ultimate load capability, depends on the degree to which the failure is understood and the analysis can be validated by the test.

– END –

SPECIAL CONDITION and IM	C-15 SC & IM: Design Dive Speed V_d
APPLICABILITY:	A380
REQUIREMENTS:	JAR 25.335 (b)(1) and (b) (2)
ADVISORY MATERIAL:	ACJ 25.335 (b) (2)

BACKGROUND

1) The A380 is equipped with a high speed protection system which limits nose down pilot authority at speeds above V_C/M_C , and prevent the aircraft from performing the manoeuvre required under 25.335(b)(1) . The requirement of JAR 25.335 (b) (1) must therefore be adapted.

JAR 25 has not yet been amended to consider aircraft with high speed protection systems. Therefore, in accordance with JAR 21.16(a) (1), a special condition should be issued to amend the requirements of JAR 25.335 (b) (1).

2) Regarding ACJ 25.335 (b) (2), a harmonised material for atmospheric variation aspects is in the draft AC 25.335-1 and has been accepted by the JAA / FAA LDHWG Group, in their February 2000 meeting.

The following Special Condition, also existing on Airbus SA and LR family, allow adapt JAR 25 requirements to technology used on Airbus aircraft.

SPECIAL CONDITION

Modify JAR 335(b)(1) to read:

(1) The speed increase above V_C/M_C resulting from the following manoeuvres:

- (i) From an initial condition of stabilised flight at V_C/M_C , the aeroplane is upset so as to take up a new flight path 7.5° below the initial path. Control application, up to full authority, is made to try and maintain this new flight path. Twenty seconds after initiating the upset manual recovery is made at a load factor of 1.5 g (0.5 g acceleration increment), or such greater load factor that is automatically applied by the system with the pilot's pitch control neutral. The speed increase occurring in this manoeuvre may be calculated, if reliable or conservative aerodynamic data is used. Power as specified in JAR 25.175 (b)(1)(iv) is assumed until recovery is made, at which time power reduction and the use of pilot controlled drag devices may be assumed.
- (ii) From a speed below V_C/M_C , with power to maintain stabilised level flight at this speed the aeroplane is upset so as to accelerate through V_C/M_C at a flight path 15° below the initial path (or at the steepest nose down attitude that the system will permit with full control authority if less than 15°).

Note: Pilots controls may be in neutral position after reaching V_C/M_C and before recovery is initiated.

Recovery may be initiated 3 seconds after operation of high speed, attitude or other alerting system by application of a load factors of 1.5 g (0.5 g acceleration increment), or such greater load factor that is automatically applied by the system with the pilot's pitch control neutral. Power may be reduced simultaneously.

All other means of decelerating the aeroplane, the use of which is authorised up to the highest speed reached in the manoeuvre, may be used. The interval between successive pilot actions must not be less than one second.

INTERPRETATIVE MATERIAL**I) REVISION TO ACJ 25.335 (b) (2) / AC 25.335-1**

1. **PURPOSE.** This advisory circular (AC) sets forth an acceptable means, but not the only means, of demonstrating compliance with the airworthiness standards for transport category airplanes related to the minimum speed margin between design cruise speed and design dive speed. Like all AC's, it is not regulatory but provides guidance for applicants in demonstrating compliance with the objective safety standards set forth in the rule.
2. **CANCELATION.** Advisory Circular 25.335-1, Design Dive Speed, dated 10/20/97, is canceled.
3. **RELATED FAR SECTIONS.** Part 25, Section 25.335 "Design airspeeds."
4. **BACKGROUND.** Section 25.335(b) requires the design dive speed, V_D , of the airplane to be established so that the design cruise speed is no greater than 0.8 times the design dive speed, or that it be based on an upset criterion initiated at the design cruise speed, V_C . At altitudes where the cruise speed is limited by compressibility effects, § 25.335(b)(2) requires the margin to be not less than 0.05 Mach. Furthermore, at any altitude, the margin must be great enough to provide for atmospheric variations (such as horizontal gusts and the penetration of jet streams), instrument errors, and production variations. This AC provides a rational method for considering the atmospheric variations.
5. **DESIGN DIVE SPEED MARGIN DUE TO ATMOSPHERIC VARIATIONS.**
 - a. In the absence of evidence supporting alternative criteria, compliance with § 25.335(b)(2) may be shown by providing a margin between V_C/M_C and V_D/M_D sufficient to provide for the following atmospheric conditions:
 - (1) **Encounter with a Horizontal Gust.** The effect of encounters with a substantially head-on gust, assumed to act at the most adverse angle between 30 degrees above and 30 degrees below the flight path, should be considered. The gust velocity should be 50 fps in equivalent airspeed (EAS) at altitudes up to 20,000 feet. At altitudes above 20,000 feet the gust velocity may be reduced linearly from 50 fps in EAS at 20,000 feet to 25 fps in EAS at 50,000 feet, above which the gust velocity is considered to be constant. The gust velocity should be assumed to build up in not more than 2 seconds and last for 30 seconds.
 - (2) **Entry into Jetstreams or Regions of High Windshear.**
 - (i) Conditions of horizontal and vertical windshear should be investigated taking into account the windshear data of this paragraph which are world-wide extreme values.
 - (ii) Horizontal windshear is the rate of change of horizontal wind speed with horizontal distance. Encounters with horizontal windshear change the airplane apparent head wind in level flight as the airplane traverses into regions of changing wind speed. The horizontal windshear region is assumed to have no significant vertical gradient of wind speed.
 - (iii) Vertical windshear is the rate of change of horizontal wind speed with altitude. Encounters with windshear change the airplane apparent head wind as the airplane climbs or descends into regions of changing wind speed. The vertical windshear region changes slowly so that temporal or spatial changes in the vertical windshear gradient are assumed to have no significant effect on an airplane in level flight.

(iv) With the airplane at VC/MC within normal rates of climb and descent, the most extreme condition of windshear that it might encounter, according to available meteorological data, can be expressed as follows:

- (A) **Horizontal Windshear.** The jet stream is assumed to consist of a linear shear of 3.6 KTAS/NM over a distance of 25 NM or of 2.52 KTAS/NM over a distance of 50 NM or of 1.8 KTAS/NM over a distance of 100 NM, whichever is most severe.
- (B) **Vertical Windshear.** The windshear region is assumed to have the most severe of the following characteristics and design values for windshear intensity and height band. As shown in Figure 1, the total vertical thickness of the windshear region is twice the height band so that the windshear intensity specified in Table 1 applies to a vertical distance equal to the height band above and below the reference altitude. The variation of horizontal wind speed with altitude in the windshear region is linear through the height band from zero at the edge of the region to strength at the reference altitude determined by the windshear intensity multiplied by the height band. Windshear intensity varies linearly between the reference altitudes in Table 1.

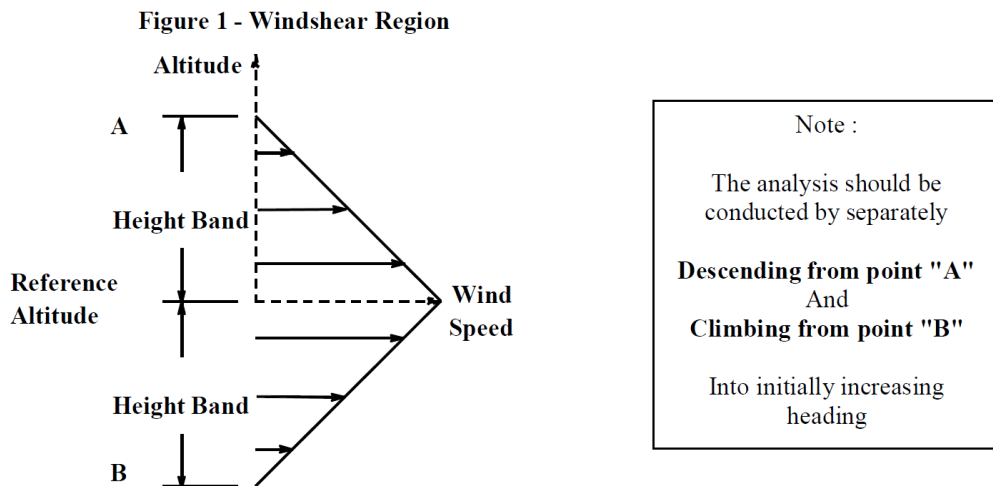

Table 1 - Vertical Windshear Intensity Characteristics

	Height Band - Ft.			
	1000	3000	5000	7000
Reference Altitude - Ft.	Vertical Windshear Units: ft./sec. per foot of height (KTAS per 1000 feet of height)			
0	0.095 (56.3)	0.05 (29.6)	0.035 (20.7)	0.03 (17.8)
40,000	0.145 (85.9)	0.075 (44.4)	0.055 (32.6)	0.04 (23.7)
45,000	0.265 (157.0)	0.135 (80.0)	0.10 (59.2)	0.075 (44.4)
Above 45,000	0.265 (157.0)	0.135 (80.0)	0.10 (59.2)	0.075 (44.4)
Windshear intensity varies linearly between specified altitudes.				

- (v) The entry of the airplane into horizontal and vertical windshear should be treated as separate cases. Because the penetration of these large scale phenomena is fairly slow, recovery action by the pilot is usually possible. In the case of manual flight (i.e., when flight is being controlled by inputs made by the pilot), the airplane is assumed to maintain constant attitude until at least 3 seconds after the operation of the overspeed warning device, at which time recovery action may be started by using the primary aerodynamic controls and thrust at a normal acceleration of 1.5g, or the maximum available, whichever is lower.
- b. At altitudes where speed is limited by Mach number, a speed margin of .07 Mach between MC and MD is considered sufficient without further investigation.

II) FAILURE OF THE OVERSPEED PROTECTION

In any failure condition affecting the High speed protection function, the above defined interpretations still remain applicable.

It implies that a specific value, which may be different from the V_D/M_D value in normal configuration, has to be associated with this failure condition for the definition of loads related to V_D as well as for the justification to JAR 25.629. However, the strength and speed margin required will depend on the probability of this failure condition, according to the criteria of SC C-11.

– END –

SPECIAL CONDITION	C-16 SC: Limit Pilot Forces
APPLICABILITY:	A380
REQUIREMENTS:	JAR 25.397(c)
ADVISORY MATERIAL:	N/A

BACKGROUND

The A380 is equipped with a side stick instead of a conventional control stick. The requirement of JAR 25.397(c) which defines limit pilot forces and torques applies to conventional wheel or stick control and is therefore not adequate. In accordance with JAR 21.16 (a)(1), a special condition must be issued to adapt 25.397(c) to side stick controls.

The following Special Condition, also existing on Airbus SA and LR family, allow adapt JAR 25 requirements to technology used on Airbus aircraft.

SPECIAL CONDITION

For the A380 equipped with stick controls designed for forces to be applied by one wrist and not arms, the limit pilot forces are as follows:

- 1) For all components between and including the handle and its control stops.

PITCH	ROLL
Nose up 200 lb f.	Nose left 100 lb f.
Nose down 200 lb f.	Nose right 100 lb f.

- 2) For all other components of the Side stick control assembly, but excluding the internal components of the electrical sensor assemblies, to avoid damage as a result of an in-flight JAM.

PITCH	ROLL
Nose up 125 lb f.	Nose left 50 lb f.
Nose down 125 lb f.	Nose right 50 lb f.

– END –

EQUIVALENT SAFETY FINDING	C-19 ESF: Checked Pitching Manoeuvre loads
APPLICABILITY:	A380
REQUIREMENTS:	JAR 25.331 (c)(2)
ADVISORY MATERIAL:	ACJ 25.331 (c)(2)

BACKGROUND

JAR 25.331 (c)(2) at Change 15 states that "*Checked Manoeuvre between VA and VD. A checked manoeuvre, based on a rational pitching control motion versus time profile must be established in which the design limit load factor specified in JAR 25.337 will not be exceeded (see also ACJ 25.331 (c)(2))*".

For A380, Airbus has elected to comply to P-NPA 25C-308 Checked Pitching Manoeuvre and requested an Equivalent Safety Finding to JAR 25.331 (c)(2) at change 15.

The background justification for the Equivalent Safety Finding is contained in P-NPA 25C-308 dated 29/02/2000 and the main technical issues are :

- (a) Introduction of sinusoidal cockpit pitch control command in the rule (previously contained in ACJ);
- (b) Introduction of extended sinusoidal input (in rule) to account for advanced flight control systems;
- (c) Introduction of considerations on effect of stick pusher/shaker.

The proposed rule and advisory material are an improvement compared to the current rule and advisory material on this subject.

EQUIVALENT SAFETY FINDING

1. Amend JAR 25.331(c)(2) to read as follows:

JAR 25.331 Symmetric manoeuvring conditions.

(c) Manoeuvring pitching conditions. The following conditions must be investigated:

(1) * * * * *

(2) Checked manoeuvre between V_A and V_D . Nose up checked pitching manoeuvres must be analysed in which the positive limit load factor prescribed in JAR 25.337 is achieved.

As a separate condition, nose down checked pitching manoeuvres must be analysed in which a limit load factor of 0g is achieved. In defining the aeroplane loads the cockpit pitch control motions described in sub-paragraphs (i), (ii), (iii) and (iv) of this paragraph must be used:

(i) The aeroplane is assumed to be flying in steady level flight at any speed between V_A and V_D and the cockpit pitch control is moved in accordance with the following formula:

$$\delta(t) = \delta_1 \sin(\omega t) \text{ for } 0 \leq \omega t \leq t_{\max}$$

where:

- δ_1 = the maximum available displacement of the cockpit pitch control in the initial direction, as limited by the control system stops, control surface stops, or by pilot effort in accordance with JAR 25.397(b);
- $\delta(t)$ = the displacement of the cockpit pitch control as a function of time. In the initial direction $\delta(t)$ is limited to δ_1 . In the reverse direction, $\delta(t)$ may be truncated at the maximum

available displacement of the cockpit pitch control as limited by the control system stops, control surface stops, or by pilot effort in accordance with JAR 25.397(b);

- $t_{max} = 3\pi/2\omega$
- $\omega =$ the circular frequency (radians/second) of the control deflection taken equal to the undamped natural frequency of the short period rigid mode of the aeroplane, with active control system effects included where appropriate; but not less than:

$$\omega = \frac{\pi * V}{2V_A} \text{ radians per second;}$$

where:

- $V =$ the speed of the aeroplane at entry to the manoeuvre.
- $V_A =$ the design manoeuvring speed prescribed in JAR 25.335(c)

(ii) For nose-up pitching manoeuvres the complete cockpit pitch control displacement history may be scaled down in amplitude to the extent just necessary to ensure that the positive limit load factor prescribed in JAR 25.337 is not exceeded. For nose-down pitching manoeuvres the complete cockpit control displacement history may be scaled down in amplitude to the extent just necessary to ensure that the normal acceleration at the e.g. does not go below 0g.

(iii) In addition, for cases where the aeroplane response to the specified cockpit pitch control motion does not achieve the prescribed limit load factors then the following cockpit pitch control motion must be used:

$$\begin{aligned} \delta(t) &= \delta_1 \sin(\omega t) && \text{for } 0 \leq t \leq t_1 \\ \delta(t) &= \delta_1 && \text{for } t_1 \leq t \leq t_2 \\ \delta(t) &= \delta_1 \sin(\omega[t + t_1 + t_2]) && \text{for } t_2 \leq t \leq t_{max} \end{aligned}$$

where:

- $t_1 = \pi/2\omega$
- $t_2 = t_1 + \Delta t$
- $t_{max} = t_2 + \pi/\omega$
- $\Delta t =$ the minimum period of time necessary to allow the prescribed limit load factor to be achieved in the initial direction, but it need not exceed five seconds (see figure below).

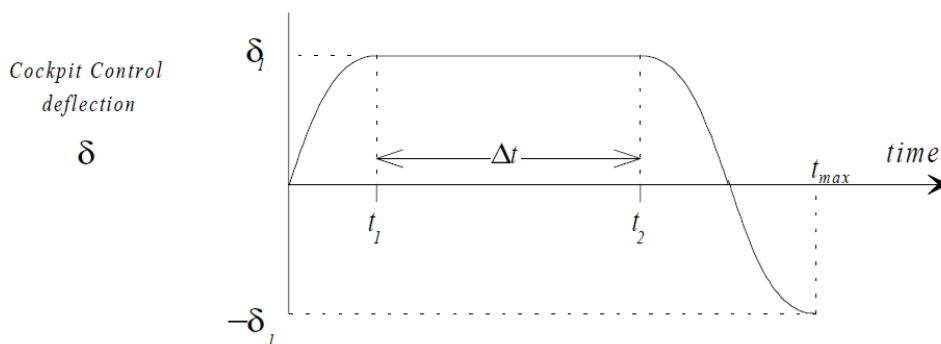

(iv) In cases where the

cockpit pitch control motion may be affected by inputs from systems (for example, by a stick pusher that can operate at high load factor as well as at 1g) then the effects of those systems shall be taken into account.

(v) Aeroplane loads that occur beyond the following times need not be considered:

- (1) For the nose-up pitching manoeuvre, the time at which the normal acceleration at the e.g. goes below 0g;
- (2) For the nose-down pitching manoeuvre, the time at which the normal acceleration at the e.g. goes above the positive limit load factor prescribed in JAR 25.337;
- (3) t_{max} .

2. Delete ACJ 25.331(c)(2).

– END –

EQUIVALENT SAFETY FINDING and IM	C-20 ESF & IM: Engine failure loads
APPLICABILITY:	A380
REQUIREMENTS:	JAR 25.361 (b)(c) and (d)
ADVISORY MATERIAL:	N/A

BACKGROUND

JAR 25.361 (b) at change 15 requires that "*For turbine engines and auxiliary power unit installations, the limit torque load imposed by sudden stoppage due to a malfunction or structural failure (such as compressor jamming) must be considered in the design of engine and auxiliary power unit mounts and supporting structure. In the absence of better information a sudden stoppage must be assumed to occur in 3 seconds*".

For A380, Airbus has elected to comply to the P-NPA 25C-305 Engine and Auxiliary Power Unit Load Conditions dated 8/03/2000, which has been accepted by the JAA / FAA Loads Harmonisation Working Group, in their September 1999 meeting.

Airbus has therefore requested an Equivalent Safety Finding to JAR 25.361 (b) (c) and (d) at change 15 and proposes to show compliance to JAR 25. 361 (b) (c) and (d) using the harmonised position between JAA and FAA as established within the ARAC Loads and Dynamics Harmonisation Working Group.

EQUIVALENT SAFETY FINDING

1. Amend JAR 25.361 to read as follows:

JAR 25.361 Engine and auxiliary power unit torque

- (a) Each engine mount and its supporting structure must be designed for the effects of:
 - (1) a limit engine torque corresponding to take-off power and propeller speed acting simultaneously with 75 percent of the limit loads from flight condition A of JAR 25.333(b);
 - (2) a limit torque corresponding to the maximum continuous power and propeller speed, acting simultaneously with the limit loads from flight condition A of JAR 25.333(b); and
 - (3) for turbo-propeller installations, in addition to the conditions specified in subparagraphs (a)(1) and (a)(2), a limit engine torque corresponding to take-off power and propeller speed, multiplied by a factor accounting for propeller control system malfunction, including quick feathering, acting simultaneously with 1g level flight loads. In the absence of a rational analysis, a factor of 1.6 must be used.
- (b) The limit engine torque to be considered under subparagraph (a) must be obtained by multiplying mean torque for the specified power and speed by a factor of:
 - (1) 1.25 for turbo-propeller installations;
 - (2) 1.33 for reciprocating engines.
- (c) For turbine engine installations, the engine mounts, pylons, and adjacent supporting airframe structure must be designed to withstand 1g level flight loads acting simultaneously with the maximum limit torque loads imposed by each of the following:
 - 1) sudden engine deceleration due to a malfunction which could result in a temporary loss of power or thrust; and
 - 2) the maximum acceleration of the engine.

- (d) For auxiliary power unit installations, the power unit mounts and adjacent supporting airframe structure must be designed to withstand 1g level flight loads acting simultaneously with the maximum limit torque loads imposed by each of the following:
- (1) sudden auxiliary power unit deceleration due to malfunction or structural failure; and
 - (2) the maximum acceleration of the power unit.

2. Add a new JAR 25.362 to read as follows:

JAR 25.362 Engine failure loads

- (a) For engine supporting structure, an ultimate loading condition must be considered that combines 1g flight loads with the transient dynamic loads resulting from:
- (1) the loss of any fan, compressor, or turbine blade; and
 - (2) separately, where applicable to a specific engine design, any other engine structural failure that results in higher loads.
- (b) The ultimate loads developed from the conditions specified in paragraph (a) are to be:
- (1) multiplied by a factor of 1.0 when applied to engine mounts and pylons; and
 - (2) multiplied by a factor of 1.25 when applied to adjacent supporting airframe structure.

INTERPRETATIVE MATERIAL

Add a new ACJ 25.362 to read as follows:

ACJ 25.362

Engine Failure Loads (Interpretative Material and Acceptable Means of Compliance)

See JAR 25.362

1. **PURPOSE.** This ACJ describes an acceptable means for showing compliance with the requirements of JAR 25.362 “Engine failure loads”. These means are intended to provide guidance to supplement the engineering and operational judgement that must form the basis of any compliance findings relative to the design of engine mounts and their supporting structures for loads developed from the engine failure conditions described in JAR 25.362.
2. **RELATED JAR PARAGRAPHS.**
 - a. **JAR-25:**
JAR 25.361 “Engine failure loads”
JAR 25.901 “Powerplant installation”
 - b. **JAR-E:**
JAR-E 810 “Compressor and turbine blade failure”
3. **DEFINITIONS.** Some new terms have been defined for the transient engine failure conditions in order to present criteria in a precise and consistent manner in the following pages.
In addition, some terms are employed from other fields and may not necessarily be in general use. For the purposes of this ACJ, the following definitions should be used.
 - a. **Adjacent supporting airframe structure:** Those parts of the primary airframe that are directly affected by loads arising within the engine.
 - b. **Blade loss:** The loss of the most critical fan, compressor, or turbine blade.
 - c. **Ground Vibration Test:** Ground resonance tests of the aeroplane normally conducted for compliance with JAR 25.629, “Aeroelastic stability requirements.”

- d. Transient failure loads: Those loads occurring from the time of the engine structural failure, up to the time at which the engine stops rotating or achieves a steady windmilling rotational speed.
- e. Windmilling engine rotational speed: The speed at which the rotating shaft systems of an unpowered engine will rotate due to the flow of air into the engine as a result of the forward motion of the aeroplane.

4. **BACKGROUND.**

- a. Requirements. JAR 25.362 (“Engine failure loads”) requires that the engine mounts, pylons, and adjacent supporting airframe structure be designed to withstand 1g flight loads combined with transient dynamic loads resulting from each engine structural failure condition.
- b. Engine failure loads. Turbine engines have experienced failure conditions that have resulted in sudden engine deceleration and, in some cases, seizures. These failure conditions are usually caused by internal structural failures or ingestion of foreign objects, such as birds or ice. Whatever the source, these conditions may produce significant structural loads on the engine, engine mounts, pylon, and adjacent supporting airframe structure. With the development of larger high-bypass ratio turbine engines, it became apparent that engine seizure torque loads alone did not adequately define the full loading imposed on the engine mounts, pylons, and their adjacent supporting airframe structure. The progression to high-bypass ratio turbine engines of larger diameter and fewer blades with larger chords has increased the magnitude of the transient loads that can be produced during and following engine failures. Consequently, for engine failure events, it is considered necessary that the applicant perform dynamic analysis that considers all load components.

A dynamic model of the aircraft and engine configuration must be sufficiently detailed to characterise the transient loads for the engine mounts, pylons, and adjacent supporting airframe structure during the failure event and subsequent run down.

- c. Engine structural failure conditions. Of all the applicable engine structural failure conditions, design and test experience have shown that the loss of a blade is likely to produce the most severe loads on the engine and airframe. Therefore, JAR 25.362 requires that the transient dynamic loads from these blade failure conditions be considered when evaluating structural integrity. However, service history shows examples of other severe engine structural failures where the engine thrust-producing capability was lost, and the engine experienced extensive internal damage. For each specific engine design, the applicant should consider whether these types of failures are applicable, and if they present a more critical load condition than blade loss. Examples of other engine structural failure conditions that should be considered in this respect are:
 - failure of a shaft, or
 - failure or loss of any shaft support bearing.

5. **EVALUATION OF TRANSIENT FAILURE CONDITIONS**

- a. Objective. The applicant should show, by a combination of tests and analyses, that the aeroplane is capable of continued safe flight and landing after loss of a blade, including ensuing damage to other parts of the engine.

The primary failure condition is expected to be blade release (refer to JAR-E 810 “Compressor and Turbine Blade Failure”). However, other structural failures may need to be considered as well, depending upon the engine configuration.

The applicant also should consider the transient loads from the time of the engine structural failure, up to the time at which the engine stops rotating or achieves a steady

Windmilling rotational speed. (Note: The effects of continued rotation (windmilling) are described in ACJ 25.901(c).)

- b. Evaluation. The applicant's evaluation should show that, from the moment of engine structural failure and during spool-down to the time of windmilling engine rotational speed, the engine-induced loads and vibrations will not cause failure of the engine mounts, pylon, and adjacent supporting airframe structure.

Major engine structural failure events are considered as ultimate load conditions, since they occur at a sufficiently infrequent rate. For design of the engine mounts and pylon, the ultimate loads may be taken without any additional multiplying factors. At the same time, protection of the basic airframe is assured by using a multiplying factor of 1.25 on those ultimate loads for the design of the adjacent supporting airframe structure.

- c. Blade loss condition. The applicant should determine loads on the engine mounts, pylon, and adjacent supporting airframe structure by dynamic analysis. The analysis should take into account all significant structural degrees of freedom. The transient engine loads should be determined for the fan blade failure condition and rotor speed, as specified in JAR-E 810, and over the full range of blade release angles to allow determination of the critical loads for all affected components. The amount of engine damage that develops during the failure event and, consequently, the loads produced, depends on material properties and temperature. Therefore, the analysis of transient engine loads should consider the effects of variations in engine material properties and temperature. This step in the analysis may be satisfied by analysing:

- the engine stiffness characteristics at typical flight temperatures, and
- the engine strength and deflection characteristics at maximum design temperatures.

The forcing function to be applied to the pylon and airframe is normally generated and validated by the engine manufacturer, including those changes needed to represent the critical flight conditions.

The analysis of incremental transient airframe loads should consider:

- the effects of the engine mounting station on the aeroplane (i.e., right side, left side, inboard position, etc.); and
- the most critical aeroplane mass distribution (i.e., fuel loading for wingmounted engines and payload distribution for fuselage-mounted engines).

For calculation of the combined ultimate airframe loads, the 1g component may be associated with typical flight conditions.

- d. Other failure conditions. If any other engine structural failure conditions, applicable to the specific engine design, are identified that present a more critical load condition than the blade loss condition, they should be evaluated by dynamic analysis to a similar standard and using similar assumptions to those described in paragraph 5.c., above.

6. ANALYSIS METHODOLOGY.

- a. Objective of the methodology. The objective of the analysis methodology is to develop acceptable analytical tools for conducting investigations of dynamic engine structural failure events. The goal of the analysis is to produce loads and accelerations suitable for evaluations of structural integrity. However, where required for compliance with JAR 25.901 ("Powerplant installation"), loads and accelerations may also need to be produced for evaluating the continued function of systems related to the engine installation that are essential for immediate flight safety (for example, fire bottles and fuel shut off valves).
- b. Scope of the analysis. The analysis of the aircraft and engine configuration should be sufficiently detailed to determine the transient and steady-state loads for the engine

mounts, pylon, and adjacent supporting airframe structure during the engine failure event and subsequent run-down.

7. MATHEMATICAL MODELING AND VALIDATION.

a. Components of the integrated dynamic model. The applicant should calculate airframe dynamic responses with an integrated model of the engine, pylon, and airframe structure. The integrated dynamic model used for engine structural failure analyses should be representative of the aeroplane to the highest frequency needed to accurately represent the transient response. The integrated dynamic model consists of the following components that may be validated independently:

- Airframe structural model.
- Engine structural model.

b. Airframe Structural Model and Validation.

(1) An analytical model of the airframe is necessary in order to calculate the airframe responses due to the transient forces produced by the engine failure event. The airframe manufacturers currently use reduced lumped mass finite element analytical models of the airframe for certification of aeroelastic stability (flutter) and dynamic loads. A typical model consists of relatively few lumped masses connected by weightless beams. A full aeroplane model is not usually necessary for the engine failure analysis, and it is normally not necessary to consider the whole aircraft response, the effects of automatic flight control systems, or unsteady aerodynamics.

(2) A lumped mass beam model of the airframe, similar to that normally used for flutter analysis, is acceptable for frequency response analyses due to engine structural failure conditions. However, additional detail may be needed to ensure adequate fidelity for the engine structural failure frequency range. In particular, the engine structural failure analysis requires calculating the response of the airframe at higher frequencies than are usually needed to obtain accurate results for the other loads analyses, such as dynamic gust and landing impact. The applicant should use finite element models as necessary. As far as possible, the ground vibration tests normally conducted for compliance with JAR 25.629 (“Aeroelastic stability requirements”) should be used to validate the analytical model.

(3) Structural dynamic models include damping properties, as well as representations of mass and stiffness distributions. In the absence of better information, it will normally be acceptable to assume a value of 0.03 (i.e., 1.5% equivalent critical viscous damping) for all flexible modes. Structural damping may be increased over the 0.03 value to be consistent with the high structural response levels caused by extreme failure loads, provided it is justified.

c. Engine Structural Model and Validation.

(1) Engine manufacturers construct various types of dynamic models to determine loads and to perform dynamic analyses on the engine rotating components, static structures, mounts, and nacelle components. Dynamic engine models can range from a centreline two-dimensional (2D) model, to a centreline model with appropriate three-dimensional (3D) features, such as mount and pylon, up to a full 3D finite element model.

(2) Detailed finite element models typically include all major components of the propulsion system, such as:

- the nacelle intake,
- fan cowl doors,
- thrust reverser,
- common nozzle assembly,
- all structural casings,

- frames,
- bearing housings,
- rotors,
- gearbox, and
- a representative pylon.

Gyroscopic effects are included. The finite element models provide for representative connections at the engine-to-eylon interfaces, as well as all interfaces between components (e.g., inlet-to-engine and engine-to-thrust reverser).

- (3) Features modelled specifically for blade loss analysis typically include:
- fan imbalance,
 - component failure,
 - rubs (blade-to-casing, and intershaft),
 - resulting stiffness changes, and
 - aerodynamic effects, such as thrust loss and engine surge.

Manufacturers whose engines fail the rotor support structure by design during the blade loss event should also evaluate the effect of the loss of support on engine structural response.

- (4) The model should be validated based on vibration tests and results of the blade loss test required for compliance with JAR-E 810, giving due allowance for the effects of the test mount structure. The model should be capable of accurately predicting the transient loads from blade release through run-down to steady state. In cases where compliance with JAR-E 810 is granted by similarity instead of test, the model should be correlated to prior experience. For compliance with JAR 25.362, the engine model, once validated, should be modified to include the influence of representative adjacent supporting airframe structure.
- (5) Validation of the engine model static structure including the pylon is achieved by a combination of engine and component tests, which include structural tests on major load path components. The adequacy of the engine model to predict rotor critical speeds and forced response behaviour is verified by measuring engine vibratory response when imbalances are added to the fan and other rotors. Vibration data are routinely monitored on a number of engines during the engine development cycle, thereby providing a solid basis for model correlation.
- (6) Correlation of the model against the JAR-E 810 blade loss engine test is a demonstration for which the model accurately predicts:
- initial blade release event loads,
 - any rundown resonant response behaviour,
 - frequencies,
 - potential structural failure sequences, and
 - general engine movements and displacements.
- To enable this correlation to be performed, instrumentation of the blade loss engine test should be used (e.g., use of high-speed cinema and video cameras, accelerometers, strain gauges, continuity wires, and shaft speed tachometers). This instrumentation should be capable of measuring loads on the engine attachment structure.
- (7) The airframe and engine manufacturers should mutually agree upon the definition of the model, based on test and experience.

– END –

EQUIVALENT SAFETY FINDING and IM	C-21 ESF & IM: Continuous turbulence loads
APPLICABILITY:	A380
REQUIREMENTS:	JAR 25.341, 25.343, 25.345, 25.371, 25.373, 25.391, 25.1517
ADVISORY MATERIAL:	ACJ 25.341 (b)

BACKGROUND

Current JAR 25.341 (b) requires that "*The dynamic response to symmetrical vertical and lateral continuous turbulence must be taken into account (See ACJ 25.341 (b))*". ACJ 25.341 (b) provides acceptable criteria for assessing the effects of dynamic response to continuous turbulence.

Airbus has requested an Equivalent Safety Finding to JAR 25.341(b) at change 15 and proposes to show compliance to JAR 25. 341(b) using P-NPA 25C-309 issue March 2000 "Revised Requirements for Gust and Continuous Turbulence Design Loads" ; this P-NPA contains the harmonised position between JAA and FAA as established within the ARAC Loads and Dynamics Harmonisation Working Group.

The main technical issues of the P-NPA 25C-309 are :

- (a) Revision of continuous turbulence intensities (to match database for gust velocities) in rule ;
- (b) Deletion of mission analysis in AC(J):
- (c) Introduction of multi axis discrete gust for wing mounted engines in rule;
- (d) definition of gust velocities extended from 50,000 ft to 60,000 ft in rule ;
- (e) addressing non-linear systems in rule and AC (J) ;
- (f) redefinition of Vra/Mra in rule.

EQUIVALENT SAFETY FINDING

1. To amend JAR 25.341 by revising subparagraph 25.341(a)(5)(i) to read as follows:

(a) * * * * *

(5) The following reference gust velocities apply:

(i) At aeroplane speeds between V_B and V_C :

Positive and negative gusts with reference gust velocities of 56.0 ft/sec EAS must be considered at sea level. The reference gust velocity may be reduced linearly from 56.0 ft/sec EAS at sea level to 44.0 ft/sec EAS at 15 000 feet. The reference gust velocity may be further reduced linearly from 44.0 ft/sec EAS at 15 000 feet to 20.86 ft/sec EAS at 60 000 feet.

* * * * *

2. To amend JAR 25.341 by revising subparagraph 25.341(b) and subparagraph 25.341(c) to read as follows:

(b) *Continuous Turbulence Design Criteria.* The dynamic response of the aeroplane to vertical and lateral continuous turbulence must be taken into account. The dynamic analysis must take into account unsteady aerodynamic characteristics and all significant structural degrees of freedom including rigid body motions. The limit loads must be determined for all critical altitudes, weights, and weight distributions as specified in JAR 25.321(b), and all critical speeds within the ranges indicated in subparagraph (b)(3).

(1) Except as provided in subparagraphs (b)(4) and (b)(5) of this paragraph, the following equation must be used:

$$P_L = P_{L-1g} \pm U_{\sigma} \bar{A}$$

Where:

- P_L = limit load;
- P_{L-1g} = steady 1-g load for the condition;
- \bar{A} = ratio of root-mean-square incremental load for the condition to root-mean-square turbulence velocity; and
- U_σ = limit turbulence intensity in true airspeed, specified in subparagraph (b)(3) of this paragraph.

(2) Values of A must be determined according to the following formula:

$$\bar{A} = \sqrt{\int_0^\infty |H(\Omega)|^2 \Phi(\Omega) d\Omega}$$

Where:

- $H(\Omega)$ = the frequency response function, determined by dynamic analysis, that relates the loads in the aircraft structure to the atmospheric turbulence; and
- $\Phi(\Omega)$ = normalised power spectral density of atmospheric turbulence given by:

$$\phi(\Omega) = \frac{L}{\pi} \frac{1 + \frac{8}{3}(1.339\Omega L)^2}{[1 + (1.339\Omega L)^2]^{11/6}}$$

Where:

- Ω = reduced frequency, radians per foot; and
- L = scale of turbulence = 2,500 ft.

(3) The limit turbulence intensities, U_σ , in feet per second true airspeed required for compliance with this paragraph are:

(i) At aeroplane speeds between V_B and V_C :

$$U_\sigma = U_{\sigma ref} F_g$$

Where:

- $U_{\sigma ref}$ is the reference turbulence intensity that varies linearly with altitude from 90 fps (TAS) at sea level to 79 fps (TAS) at 24000 feet and is then constant at 79 fps (TAS) up to the altitude of 60000 feet; and
- F_g is the flight profile alleviation factor defined in subparagraph (a)(6) of this paragraph;

(ii) At speed V_D : U_σ is equal to 1/2 the values obtained under subparagraph (3)(i) of this paragraph.

(iii) At speeds between V_C and V_D : U_σ is equal to a value obtained by linear interpolation.

(iv) At all speeds both positive and negative continuous turbulence must be considered.

(4) When an automatic system affecting the dynamic response of the aeroplane is included in the analysis, the effects of system non-linearities on loads at the limit load level must be taken into account in a realistic or conservative manner.

(5) If necessary for the assessment of loads on aeroplanes with significant nonlinearities, it must be assumed that the turbulence field has a root-mean-square velocity equal to 40 percent of the U_σ values specified in subparagraph (3). The value of limit load is that load with the same probability of exceedance in the turbulence field as $\bar{A}U_\sigma$ of the same load quantity in a linear approximated model.

(c) *Supplementary gust conditions for wing mounted engines.* For aeroplanes equipped with wing mounted engines, the engine mounts, pylons, and wing supporting structure must be designed for the maximum response at the nacelle centre of gravity derived from the following dynamic gust conditions applied to the aeroplane:

- (1) A discrete gust determined in accordance with JAR 25.341(a) at each angle normal to the flight path, and separately,
- (2) A pair of discrete gusts, one vertical and one lateral. The length of each of these gusts must be independently tuned to the maximum response in accordance with JAR 25.341(a). The penetration of the aeroplane in the combined gust field and the phasing of the vertical and lateral component gusts must be established to develop the maximum response to the gust pair. In the absence of a more rational analysis, the following formula must be used for each of the maximum engine loads in all six degrees of freedom:

$$P_L = P_{L-1g} + 0.85 \sqrt{L_V^2 + L_L^2}$$

Where:

- P_L = limit load;
- P_{L-1g} = steady 1-g load for the condition;
- L_V = peak incremental response load due to a vertical gust according to JAR 25.341(a); and
- L_L = peak incremental response load due to a lateral gust according to JAR 25.341(a).

3. To amend JAR 25.343 by revising subparagraph 25.343(b)(1)(ii) to read as follows:

(b) * * * * *

(1) * * * * *

- (ii) The gust and turbulence conditions of JAR 25.341, but assuming 85% of the gust velocities prescribed in JAR 25.341(a)(4) and 85% of the turbulence intensities prescribed in JAR 25.341(b)(3).

4. To amend JAR 25.345 by revising subparagraph 25.345(c)(2) to read as follows:

(c) * * * * *

- (2) The vertical gust and turbulence conditions prescribed in JAR 25.341.

5. To amend JAR 25.371 to read as follows:

JAR 25.371 Gyroscopic loads.

The structure supporting any engine or auxiliary power unit must be designed for the loads, including gyroscopic loads, arising from the conditions specified in JAR 25.331, JAR 25.341, JAR 25.349, JAR 25.351, JAR 25.473, JAR 25.479, and JAR 25.481, with the engine or auxiliary power unit at the maximum rpm appropriate to the condition. For the purposes of compliance with this paragraph, the pitch manoeuvre in JAR 25.331(c)(1) must be carried out until the positive limit manoeuvring load factor (point A2 in JAR 25.333(b)) is reached.

6. To amend JAR 25.373 by revising subparagraph 25.373(a) to read as follows:

- (a) The aeroplane must be designed for the symmetrical manoeuvres and gusts prescribed in JAR 25.333, JAR 25.337, the yawing manoeuvres in JAR 25.351, and the vertical and lateral gust and turbulence conditions prescribed in JAR 25.341(a) and (b) at each setting and the maximum speed associated with that setting; and;

* * * * *

7. To amend JAR 25.391 to read as follows:

JAR 25.391 Control surface loads: general

The control surfaces must be designed for the limit loads resulting from the flight conditions in JAR 25.331, JAR 25.341(a) and (b), JAR 25.349 and JAR 25.351 and the ground gust conditions in JAR 25.415, considering the requirements for---

* * * * *

8. To amend JAR 25.1517 to read as follows:

JAR 25.1517 Rough air speed VRA

- (a) A rough air speed V_{ra}, for use as the recommended turbulence penetration air speed, and a rough air Mach number M_{ra}, for use as the recommended turbulence penetration Mach

number, must be established to ensure that likely speed variation during rough air encounters will not cause the overspeed warning to operate too frequently.

- (b) At altitudes where V_{mo} is not limited by Mach number, in the absence of a rational investigation substantiating the use of other values, V_{ra} must be less than $V_{mo} - 35$ KTAS.
- (c) At altitudes where V_{mo} is limited by Mach number, M_{ra} may be chosen to provide an optimum margin between low and high speed buffet boundaries.

INTERPRETATIVE MATERIAL

The following are acceptable means of compliance with ESF C-21.

Amend ACJ 25.341(b) to read as follows:

ACJ 25.341(b)

Continuous Turbulence Design Criteria (Interpretative Material)

See JAR 25.341(b)

1. PURPOSE. This ACJ sets forth an acceptable means of compliance with the provisions of JAR-25 dealing with discrete gust and continuous turbulence dynamic loads.
2. RELATED JAR PARAGRAPHS. The contents of this ACJ are considered by the Authority in determining compliance with the discrete gust and continuous turbulence criteria defined in JAR 25.341. Related paragraphs are:
 - JAR 25.343 Design fuel and oil loads
 - JAR 25.345 High lift devices
 - JAR 25.349 Rolling conditions
 - JAR 25.371 Gyroscopic loads
 - JAR 25.373 Speed control devices
 - JAR 25.391 Control surface loads
 - JAR 25.427 Unsymmetrical loads
 - JAR 25 445 Auxiliary aerodynamic surfaces
 - JAR 25.571 Damage-tolerance and fatigue evaluation of structure

Reference should also be made to the following JAR paragraphs: 25.301, 25.302, 25.303, 25.305, 25.321, 25.335, 25.1517.

3. OVERVIEW. This ACJ addresses both discrete gust and continuous turbulence (or continuous gust) requirements of JAR-25. It provides some of the acceptable methods of modelling aeroplanes, aeroplane components, and configurations, and the validation of those modelling methods for the purpose of determining the response of the aeroplane to encounters with gusts.

How the various aeroplane modelling parameters are treated in the dynamic analysis can have a large influence on design load levels. The basic elements to be modelled in the analysis are the elastic, inertial, aerodynamic and control system characteristics of the complete, coupled aeroplane (Figure 1). The degree of sophistication and detail required in the modelling depends on the complexity of the aeroplane and its systems.

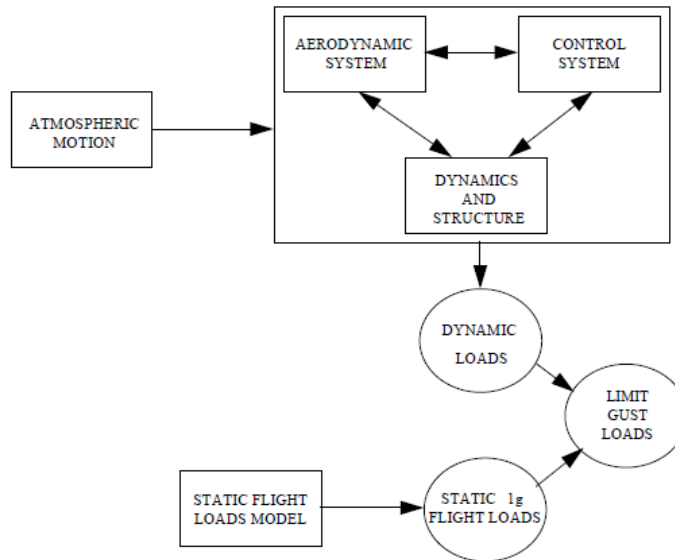

Figure 1 Basic Elements of the Gust Response Analysis

Design loads for encounters with gusts are a combination of the steady level 1-g flight loads, and the gust incremental loads including the dynamic response of the aeroplane. The steady 1-g flight loads can be realistically defined by the basic external parameters such as speed, altitude, weight and fuel load. They can be determined using static aeroelastic methods.

The gust incremental loads result from the interaction of atmospheric turbulence and aeroplane rigid body and elastic motions. They may be calculated using linear analysis methods when the aeroplane and its flight control systems are reasonably or conservatively approximated by linear analysis models.

Non-linear solution methods are necessary for aeroplane and flight control systems that are not reasonably or conservatively represented by linear analysis models. Non-linear features generally raise the level of complexity, particularly for the continuous turbulence analysis, because they often require that the solutions be carried out in the time domain.

The modelling parameters discussed in the following sections include:

- Design conditions and associated steady, level 1-g flight conditions.
- The discrete and continuous gust models of atmospheric turbulence.
- Detailed representation of the aeroplane system including structural dynamics, aerodynamics, and control system modelling.
- Solution of the equations of motion and the extraction of response loads.
- Considerations for non-linear aeroplane systems.
- Analytical model validation techniques.

4. DESIGN CONDITIONS.

- a. General. Analyses should be conducted to determine gust response loads for the aeroplane throughout its design envelope, where the design envelope is taken to include, for example, all appropriate combinations of aeroplane configuration, weight, and centre of gravity, payload, fuel load, thrust, speed, and altitude.

- b. Steady Level 1-g Flight Loads. The total design load is made up of static and dynamic load components. In calculating the static component, the aeroplane is assumed to be in trimmed steady level flight, either as the initial condition for the discrete gust evaluation or as the mean flight condition for the continuous turbulence evaluation. Static aeroelastic effects should be taken into account if significant.

To ensure that the maximum total load on each part of the aeroplane is obtained, the associated steady-state conditions should be chosen in such a way as to reasonably envelope the range of possible steady-state conditions that could be achieved in that flight condition.

Typically, this would include consideration of effects such as speed brakes, power settings between zero thrust and the maximum for the flight condition, etc.

- c. Dynamic Response Loads. The incremental loads from the dynamic gust solution are superimposed on the associated steady level flight 1-g loads. Load responses in both positive and negative senses should be assumed in calculating total gust response loads. Generally the effects of speed brakes, flaps, or other drag or high lift devices, while they should be included in the steady-state condition, may be neglected in the calculation of incremental loads.
- d. Damage Tolerance Conditions. Limit gust loads, treated as ultimate, need to be developed for the structural failure conditions considered under JAR 25.571(b). Generally, for redundant structures, significant changes in stiffness or geometry do not occur for the types of damage under consideration. As a result, the limit gust load values obtained for the undamaged aircraft may be used and applied to the failed structure. However, when structural failures of the types considered under JAR 25.571(b) cause significant changes in stiffness or geometry, or both, these changes should be taken into account when calculating limit gust loads for the damaged structure.

5. GUST MODEL CONSIDERATIONS.

- a. General. The gust criteria presented in JAR 25.341 consist of two models of atmospheric turbulence, a discrete model and a continuous turbulence model. It is beyond the scope of this ACJ to review the historical development of these models and their associated parameters. This ACJ focuses on the application of those gust criteria to establish design limit loads. The discrete gust model is used to represent single discrete extreme turbulence events.

The continuous turbulence model represents longer duration turbulence encounters which excite lightly damped modes. Dynamic loads for both atmospheric models must be considered in the structural design of the aeroplane.

- b. Discrete Gust Model

- (1) Atmosphere. The atmosphere is assumed to be one dimensional with the gust velocity acting normal (either vertically or laterally) to the direction of aeroplane travel. The one-dimensional assumption constrains the instantaneous vertical or lateral gust velocities to be the same at all points in planes normal to the direction of aeroplane travel. Design level discrete gusts are assumed to have 1-cosine velocity profiles. The maximum velocity for a discrete gust is calculated using a reference gust velocity, U_{REF} , a flight profile alleviation factor, F_g , and an expression which modifies the maximum velocity as a function of the gust gradient distance, H .

These parameters are discussed further below.

- (A) Reference Gust Velocity, U_{REF} - Derived effective gust velocities representing gusts occurring once in 70,000 flight hours are the basis for design gust velocities. These reference velocities are specified as a function of altitude in JAR 25.341(a)(5) and are

given in terms of feet per second equivalent airspeed for a gust gradient distance, H, of 350 feet.

- (B) Flight Profile Alleviation Factor, F_g - The reference gust velocity, U_{REF} , is a measure of turbulence intensity as a function of altitude. In defining the value of U_{ref} at each altitude, it is assumed that the aircraft is flown 100% of the time at that altitude. The factor F_g is then applied to account for the expected service experience in terms of the probability of the aeroplane flying at any given altitude within its certification altitude range. F_g is a minimum value at sea level, linearly increasing to 1.0 at the certified maximum altitude. The expression for F_g is given in JAR 25.341(a)(6).
- (C) Gust Gradient Distance, H - The gust gradient distance is that distance over which the gust velocity increases to a maximum value. Its value is specified as ranging from 30 to 350 ft. (It should be noted that if 12.5 times the mean geometric chord of the aeroplane’s wing exceeds 350 feet, consideration should be given to covering increased maximum gust gradient distances.)
- (D) Design Gust Velocity, U_{ds} - Maximum velocities for design gusts are proportional to the sixth root of the gust gradient distance, H. The maximum gust velocity for a given gust is then defined as:

$$U_{ds} = U_{REF} F_g (H/350)^{(1/6)}$$

The maximum design gust velocity envelope, U_{ds} , and example design gust velocity profiles are illustrated in Figure 2.

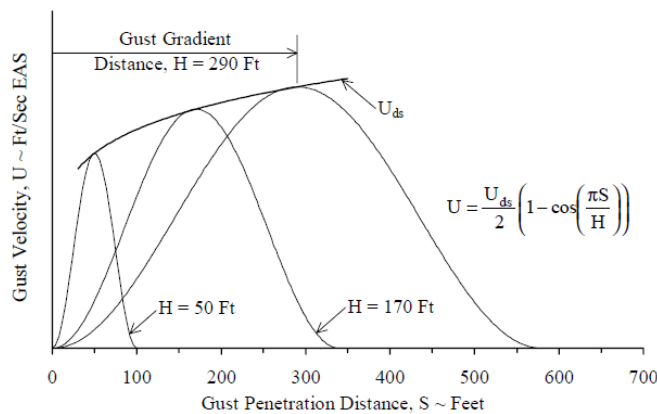

Figure-2 Typical (1-cosine) Design Gust Velocity Profiles

- (2) Discrete Gust Response. The solution for discrete gust response time histories can be achieved by a number of techniques. These include the explicit integration of the aeroplane equations of motion in the time domain, and frequency domain solutions utilising Fourier transform techniques. These are discussed further in Section 7.0 of this ACJ.

Maximum incremental loads, P_{ii} , are identified by the peak values selected from time histories arising from a series of separate, 1-cosine shaped gusts having gradient distances ranging from 30 to 350 feet. Input gust profiles should cover this gradient distance range in sufficiently small increments to determine peak loads and responses. Historically 10 to 20 gradient distances have been found to be acceptable. Both positive and negative gust velocities should be assumed in calculating total gust response loads. It should be noted that in some cases, the peak incremental loads can occur well after the prescribed gust velocity has returned to zero. In such cases, the gust response calculation should be run for sufficient additional time to ensure that the critical incremental loads are achieved.

The design limit load, P_{Li} , corresponding to the maximum incremental load, P_{li} for a given load quantity is then defined as:

$$P_{Li} = P_{(1-g)i} \pm P_{li}$$

Where $P_{(1-g)i}$ is the 1-g steady load for the load quantity under consideration. The set of time correlated design loads, P_{Lj} , corresponding to the peak value of the load quantity, P_{Lj} , are calculated for the same instant in time using the expression:

$$P_{Lj} = P_{(1-g)j} \pm P_{lj}$$

Note that in the case of a non-linear aircraft, maximum positive incremental loads may differ from maximum negative incremental loads.

When calculating stresses which depend on a combination of external loads it may be necessary to consider time correlated load sets at time instants other than those which result in peaks for individual external load quantities.

- (3) Round-The-Clock Gust. When the effect of combined vertical and lateral gusts on aeroplane components is significant, then round-the-clock analysis should be conducted on these components and supporting structures. The vertical and lateral components of the gust are assumed to have the same gust gradient distance, H and to start at the same time.

Components that should be considered include horizontal tail surfaces having appreciable dihedral or anhedral (i.e., greater than 10°), or components supported by other lifting surfaces, for example T-tails, outboard fins and winglets. Whilst the round-the-clock load assessment may be limited to just the components under consideration, the loads themselves should be calculated from a whole aeroplane dynamic analysis.

The round-the-clock gust model assumes that discrete gusts may act at any angle normal to the flight path of the aeroplane. Lateral and vertical gust components are correlated since the round-the-clock gust is a single discrete event. For a linear aeroplane system, the loads due to a gust applied from a direction intermediate to the vertical and lateral directions - the round-the-clock gust loads - can be obtained using a linear combination of the load time histories induced from pure vertical and pure lateral gusts. The resultant incremental design value for a particular load of interest is obtained by determining the round-the-clock gust angle and gust length giving the largest (tuned) response value for that load. The design limit load is then obtained using the expression for PL given above in section 5.b.2.

- (4) Supplementary Gust Conditions for Wing Mounted Engines.

- (A) Atmosphere - For aircraft equipped with wing mounted engines, JAR 25.341(c) requires that engine mounts, pylons and wing supporting structure be designed to meet a round-the-clock discrete gust requirement and a multi-axis discrete gust requirement.

The model of the atmosphere and the method for calculating response loads for the round-the-clock gust requirement is the same as that described in Section 5(b)(3) of this ACJ.

For the multi-axis gust requirement, the model of the atmosphere consists of two independent discrete gust components, one vertical and one lateral, having amplitudes such that the overall probability of the combined gust pair is the same as that of a single discrete gust as defined by JAR 25.341(a) as described in Section 5(b)(1) of this ACJ. To achieve this equal-probability condition, in addition to the reductions in gust amplitudes that would be applicable if the input were a multi-axis Gaussian process, a further factor of 0.85 is incorporated into the gust amplitudes to account for non-Gaussian properties of severe discrete gusts. This factor was derived from severe gust data obtained by a research aircraft specially instrumented to

measure vertical and lateral gust components. This information is contained in Stirling Dynamics Laboratories Report No SDL –571-TR-2 dated May 1999.

- (B) Multi-Axis Gust Response - For a particular aircraft flight condition, the calculation of a specific response load requires that the amplitudes, and the time phasing, of the two gust components be chosen, subject to the condition on overall probability specified in (A) above, such that the resulting combined load is maximised. For loads calculated using a linear aircraft model, the response load may be based upon the separately tuned vertical and lateral discrete gust responses for that load, each calculated as described in Section 5(b)(2) of this ACJ. In general, the vertical and lateral tuned gust lengths and the times to maximum response (measured from the onset of each gust) will not be the same.

Denote the independently tuned vertical and lateral incremental responses for a particular aircraft flight condition and load quantity i by L_{Vi} and L_{Li} , respectively. The associated multi-axis gust input is obtained by multiplying the amplitudes of the independently-tuned vertical and lateral discrete gusts, obtained as described in the previous paragraph, by $0.85 \cdot L_{Vi} / \sqrt{(L_{Vi}^2 + L_{Li}^2)}$ and $0.85 \cdot L_{Li} / \sqrt{(L_{Vi}^2 + L_{Li}^2)}$ respectively. The time-phasing of the two scaled gust components is such that their associated peak loads occur at the same instant.

The combined incremental response load is given by:

$$P_{ii} = 0.85 \sqrt{(L_{Vi}^2 + L_{Li}^2)}$$

and the design limit load, P_{Li} , corresponding to the maximum incremental load, P_{ii} , for the given load quantity is then given by:

$$P_{Li} = P_{(1-g)i} \pm P_{ii}$$

where $P_{(1-g)i}$ is the 1-g steady load for the load quantity under consideration.

The incremental, time correlated loads corresponding to the specific flight condition under consideration are obtained from the independently-tuned vertical and lateral gust inputs for load quantity i . The vertical and lateral gust amplitudes are factored by $0.85 \cdot L_{Vi} / \sqrt{(L_{Vi}^2 + L_{Li}^2)}$ and $0.85 \cdot L_{Li} / \sqrt{(L_{Vi}^2 + L_{Li}^2)}$ respectively. Loads L_{Vj} and L_{Lj} resulting from these reduced vertical and lateral gust inputs, at the time when the amplitude of load quantity i is at a maximum value, are added to yield the multi-axis incremental time-correlated value P_{ij} for load quantity j .

The set of time correlated design loads, P_{Lj} , corresponding to the peak value of the load quantity, P_{Li} , are obtained using the expression:

$$P_{Lj} = P_{(1-g)j} \pm P_{ij}$$

Note that with significant non-linearities, maximum positive incremental loads may differ from maximum negative incremental loads.

c. Continuous Turbulence Model.

(1) Atmosphere. The atmosphere for the determination of continuous gust responses is assumed to be one dimensional with the gust velocity acting normal (either vertically or laterally) to the direction of aeroplane travel. The one-dimensional assumption constrains the instantaneous vertical or lateral gust velocities to be the same at all points in planes normal to the direction of aeroplane travel.

The random atmosphere is assumed to have a Gaussian distribution of gust velocity intensities and a von Karman power spectral density with a scale of turbulence, L , equal to 2500 feet. The expression for the von Karman spectrum for unit, root-mean-square (RMS) gust intensity, $F_i(\Omega)$, is given below. In this expression $\Omega = w/V$ where, w is the circular frequency in radians per second, and V is the aeroplane velocity in feet per second true airspeed.

$$\Phi_1(\Omega) = \frac{L}{\pi} \frac{1 + \frac{8}{3}(1.339\Omega L)^2}{[1 + (1.339\Omega L)^2]^{1/6}}$$

The von Karman power spectrum for unit RMS gust intensity is illustrated in Figure 3.

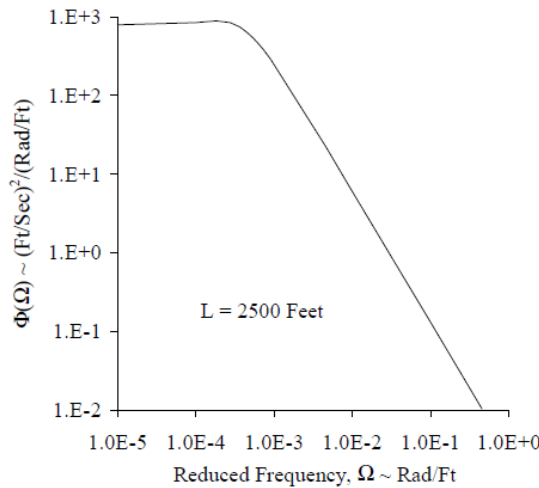

Figure-3 The von Karman Power Spectral Density Function, $F_1(W)$

The design gust velocity, U_σ , applied in the analysis is given by the product of the reference gust velocity, $U_{\sigma REF}$, and the profile alleviation factor, F_g , as follows:

$$U_\sigma = U_{\sigma REF} F_g$$

where values for $U_{\sigma REF}$, are specified in JAR 25.341(b)(3) in feet per second true airspeed and F_g is defined in JAR 25.341(a)(6). The value of F_g is based on aeroplane design parameters and is a minimum value at sea level, linearly increasing to 1.0 at the certified maximum design altitude. It is identical to that used in the discrete gust analysis.

As for the discrete gust analysis, the reference continuous turbulence gust intensity, $U_{\sigma REF}$, defines the design value of the associated gust field at each altitude. In defining the value of $U_{\sigma REF}$ at each altitude, it is assumed that the aeroplane is flown 100% of the time at that altitude. The factor F_g is then applied to account for the probability of the aeroplane flying at any given altitude during its service lifetime.

It should be noted that the reference gust velocity is comprised of two components, a root-mean-square (RMS) gust intensity and a peak to RMS ratio. The separation of these components is not defined and is not required for the linear aeroplane analysis. Guidance is provided in Section 8.d. of this AC for generating a RMS gust intensity for a non-linear simulation.

(2) Continuous Turbulence Response. For linear aeroplane systems, the solution for the response to continuous turbulence may be performed entirely in the frequency domain, using the RMS response. A is defined in JAR 25.341(b)(2) and is repeated here in modified notation for load quantity i , where:

$$\bar{A}_i = \left[\int_0^{\infty} |h_i(\Omega)|^2 \phi_I(\Omega) d\Omega \right]^{1/2}$$

or

$$\bar{A}_i = \left[\int_0^{\infty} \phi_I(\Omega) h_i(i\Omega) h_i^*(i\Omega) d\Omega \right]^{1/2}$$

In the above expression $\phi_I(\Omega)$ is the input von Karman power spectrum of the turbulence and is defined in Section 5.c. of this ACJ, $h_i(i\Omega)$ is the transfer function relating the output load quantity, i , to a unit, harmonically oscillating, one-dimensional gust field, and the asterisk superscript denotes the complex conjugate. When evaluating \bar{A}_i , the integration should be continued until a converged value is achieved since, realistically, the integration to infinity may be impractical. The design limit load, P_{Li} , is then defined as:

$$\begin{aligned} P_{Li} &= P_{(1-g)i} \pm P_{Li} \\ &= P_{(1-g)i} \pm U_{\sigma} \bar{A}_i \end{aligned}$$

where U_{σ} is defined in Section 5.c. of this ACJ, and $P_{(1-g)i}$ is the 1-g steady state value for the load quantity, i , under consideration. As indicated by the formula, both positive and negative load responses should be considered when calculating limit loads.

Correlated (or equiprobable) loads can be developed using cross-correlation coefficients, ρ_{ij} , computed as follows:

$$\rho_{ij} = \frac{\int_0^{\infty} \phi_I(\Omega) \text{real}[h_i(i\Omega) h_j^*(i\Omega)] d\Omega}{\bar{A}_i \bar{A}_j}$$

where, 'real[...]' denotes the real part of the complex function contained within the brackets. In this equation, the lowercase subscripts, i and j , denote the responses being correlated. A set of design loads, P_{Lj} , correlated to the design limit load P_{Li} , are then calculated as follows:

$$P_{Lj} = P_{(1-g)j} \pm U_{\sigma} \rho_{ij} \bar{A}_j$$

The correlated load sets calculated in the foregoing manner provide balanced load distributions corresponding to the maximum value of the response for each external load quantity, i , calculated.

When calculating stresses, the foregoing load distributions may not yield critical design values because critical stress values may depend on a combination of external loads. In these cases, a more general application of the correlation coefficient method is required. For example, when the value of stress depends on two externally applied loads, such as torsion and shear, the equiprobable relationship between the two parameters forms an ellipse as illustrated in Figure 4.

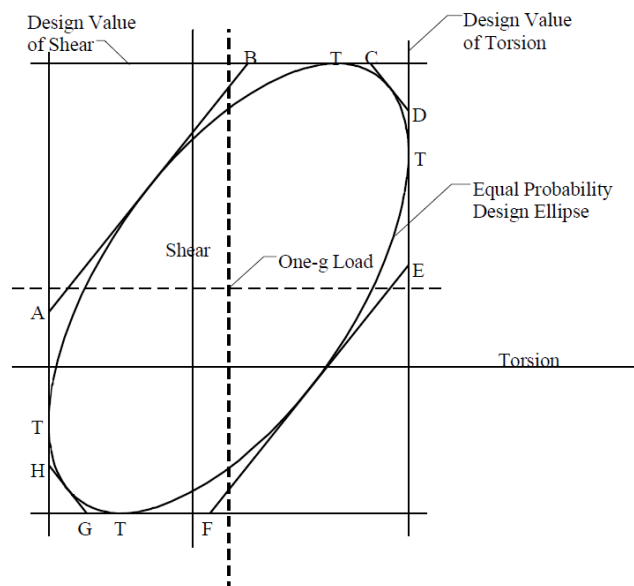

Figure-4 Equal Probability Design Ellipse

In this figure, the points of tangency, T, correspond to the expressions for correlated load pairs given by the foregoing expressions. A practical additional set of equiprobable load pairs that should be considered to establish critical design stresses are given by the points of tangency to the ellipse by lines AB, CD, EF and GH. These additional load pairs are given by the following expressions (where i = torsion and j = shear):

For tangents to lines AB and EF

$$P_{Li} = P_{(1-g)i} \pm \bar{A}_i U_\sigma [(1 - \rho_{ij})/2]^{1/2}$$

and

$$P_{Lj} = P_{(1-g)j} \mp \bar{A}_j U_\sigma [(1 - \rho_{ij})/2]^{1/2}$$

For tangents to lines CD and GH

$$P_{Li} = P_{(1-g)i} \pm \bar{A}_i U_\sigma [(1 + \rho_{ij})/2]^{1/2}$$

and

$$P_{Lj} = P_{(1-g)j} \pm \bar{A}_j U_\sigma [(1 + \rho_{ij})/2]^{1/2}$$

All correlated or equiprobable loads developed using correlation coefficients will provide balanced load distributions.

A more comprehensive approach for calculating critical design stresses that depend on a combination of external load quantities is to evaluate directly the transfer function for the stress quantity of interest from which can be calculated the gust response function, the value for RMS response, \bar{A} , and the design stress values $P_{(1-g)} \pm U_\sigma \bar{A}$.

6. AIRPLANE MODELING CONSIDERATIONS

- a. General. The procedures presented in this section generally apply for aeroplanes having aerodynamic and structural properties and flight control systems that may be reasonably or conservatively approximated using linear analysis methods for calculating limit load. Additional guidance material is presented in Section 8 of this ACJ for aeroplanes having properties and/or systems not reasonably or conservatively approximated by linear analysis methods.

- b. Structural Dynamic Model. The model should include both rigid body and flexible aeroplane degrees of freedom. If a modal approach is used, the structural dynamic model should include a sufficient number of flexible aeroplane modes to ensure both convergence of the modal superposition procedure and that responses from high frequency excitations are properly represented.

Most forms of structural modelling can be classified into two main categories: (1) the so-called “stick model” characterised by beams with lumped masses distributed along their lengths, and (2) finite element models in which all major structural components (frames, ribs, stringers, skins) are represented with mass properties defined at grid points. Regardless of the approach taken for the structural modelling, a minimum acceptable level of sophistication, consistent with configuration complexity, is necessary to represent satisfactorily the critical modes of deformation of the primary structure and control surfaces. Results from the models should be compared to test data as outlined in Section 9.b. of this ACJ in order to validate the accuracy of the model.

- c. Structural Damping. Structural dynamic models may include damping properties in addition to representations of mass and stiffness distributions. In the absence of better information it will normally be acceptable to assume 0.03 (i.e. 1.5% equivalent critical viscous damping) for all flexible modes. Structural damping may be increased over the 0.03 value to be consistent with the high structural response levels caused by extreme gust intensity, provided justification is given.
- d. Gust and Motion Response Aerodynamic Modelling. Aerodynamic forces included in the analysis are produced by both the gust velocity directly, and by the aeroplane response.

Aerodynamic modelling for dynamic gust response analyses requires the use of unsteady two-dimensional or three-dimensional panel theory methods for incompressible or compressible flow. The choice of the appropriate technique depends on the complexity of the aerodynamic configuration, the dynamic motion of the surfaces under investigation and the flight speed envelope of the aeroplane. Generally, three-dimensional panel methods achieve better modelling of the aerodynamic interference between lifting surfaces. The model should have a sufficient number of aerodynamic degrees of freedom to properly represent the steady and unsteady aerodynamic distributions under consideration.

The build-up of unsteady aerodynamic forces should be represented. In twodimensional unsteady analysis this may be achieved in either the frequency domain or the time domain through the application of oscillatory or indicial lift functions, respectively. Where three-dimensional panel aerodynamic theories are to be applied in the time domain (e.g. for non-linear gust solutions), an approach such as the ‘rational function approximation’ method may be employed to transform frequency domain aerodynamics into the time domain.

Oscillatory lift functions due to gust velocity or aeroplane response depend on the reduced frequency parameter, k . The maximum reduced frequency used in the generation of the unsteady aerodynamics should include the highest frequency of gust excitation and the highest structural frequency under consideration. Time lags representing the effect of the gradual penetration of the gust field by the aeroplane should also be accounted for in the buildup of lift due to gust velocity.

The aerodynamic modelling should be supported by tests or previous experience as indicated in Section 9.d. of this ACJ. Primary lifting and control surface distributed aerodynamic data are commonly adjusted by weighting factors in the dynamic gust response analyses. The weighting factors for steady flow ($k = 0$) may be obtained by comparing wind tunnel test results with theoretical data. The correction of the aerodynamic forces should also ensure that the rigid body motion of the aeroplane is accurately

represented in order to provide satisfactory short period and Dutch roll frequencies and damping ratios. Corrections to primary surface aerodynamic loading due to control surface deflection should be considered. Special attention should also be given to control surface hinge moments and to fuselage and nacelle aerodynamics because viscous and other effects may require more extensive adjustments to the theoretical coefficients. Aerodynamic gust forces should reflect weighting factor adjustments performed on the steady or unsteady motion response aerodynamics.

- e. Gyroscopic Loads. As specified in JAR 25.371, the structure supporting the engines and the auxiliary power units should be designed for the gyroscopic loads induced by both discrete gusts and continuous turbulence. The gyroscopic loads for turbopropellers and turbofans may be calculated as an integral part of the solution process by including the gyroscopic terms in the equations of motion or the gyroscopic loads can be superimposed after the solution of the equations of motion. Propeller and fan gyroscopic coupling forces (due to rotational direction) between symmetric and antisymmetric modes need not be taken into account if the coupling forces are shown to be negligible.

The gyroscopic loads used in this analysis should be determined with the engine or auxiliary power units at maximum continuous rpm. The mass polar moment of inertia used in calculating gyroscopic inertia terms should include the mass polar moments of inertia of all significant rotating parts taking into account their respective rotational gearing ratios and directions of rotation.

- f. Control Systems. Gust analyses of the basic configuration should include simulation of any control system for which interaction may exist with the rigid body response, structural dynamic response or external loads. If possible, these control systems should be uncoupled such that the systems which affect “symmetric flight” are included in the vertical gust analysis and those which affect “antisymmetric flight” are included in the lateral gust analysis.

The control systems considered should include all relevant modes of operation. Failure conditions should also be analysed for any control system which influences the design loads in accordance with JAR 25.302 and Appendix K.

The control systems included in the gust analysis may be assumed to be linear if the impact of the non-linearity is negligible, or if it can be shown by analysis on a similar aeroplane/control system that a linear control law representation is conservative. If the control system is significantly non-linear, and a conservative linear approximation to the control system cannot be developed, then the effect of the control system on the aeroplane responses should be evaluated in accordance with Section 8.0 of this ACJ.

- g. Stability. Solutions of the equations of motion for either discrete gusts or continuous turbulence require the dynamic model be stable. This applies for all modes, except possibly for very low frequency modes which do not affect load responses, such as the phugoid mode. (Note that the short period and Dutch roll modes do affect load responses). A stability check should be performed for the dynamic model using conventional stability criteria appropriate for the linear or non-linear system in question, and adjustments should be made to the dynamic model, as required, to achieve appropriate frequency and damping characteristics.

If control system models are to be included in the gust analysis it is advisable to check that the following characteristics are acceptable and are representative of the aeroplane;

- static margin of the unaugmented aeroplane
- dynamic stability of the unaugmented aeroplane

- the static aeroelastic effectiveness of all control surfaces utilised by any feedback control system
- gain and phase margins of any feedback control system coupled with the aeroplane rigid body and flexible modes
- the aeroelastic flutter and divergence margins of the unaugmented aeroplane, and also for any feedback control system coupled with the aeroplane.

7. DYNAMIC LOADS

- a. General. This section describes methods for formulating and solving the aeroplane equations of motion and extracting dynamic loads from the aeroplane response. The aeroplane equations of motion are solved in either physical or modal co-ordinates and include all terms important in the loads calculation including stiffness, damping, mass, and aerodynamic forces due to both aeroplane motions and gust excitation. Generally the aircraft equations are solved in modal co-ordinates. For the purposes of describing the solution of these equations in the remainder of this ACJ, modal co-ordinates will be assumed. A sufficient number of modal co-ordinates should be included to ensure that the loads extracted provide converged values.
- b. Solution of the Equations of Motion. Solution of the equations of motion can be achieved through a number of techniques. For the continuous turbulence analysis, the equations of motion are generally solved in the frequency domain. Transfer functions which relate the output response quantity to an input harmonically oscillating gust field are generated and these transfer functions are used (in Section 5.c. of this ACJ) to generate the RMS value of the output response quantity.

There are two primary approaches used to generate the output time histories for the discrete gust analysis; (1) by explicit integration of the aeroplane equations of motion in the time domain, and (2) by frequency domain solutions which can utilise Fourier transform techniques.

- c. Extraction of Loads and Responses. The output quantities that may be extracted from a gust response analysis include displacements, velocities and accelerations at structural locations; load quantities such as shears, bending moments and torques on structural components; and stresses and shear flows in structural components. The calculation of the physical responses is given by a modal superposition of the displacements, velocities and accelerations of the rigid and elastic modes of vibration of the aeroplane structure. The number of modes carried in the summation should be sufficient to ensure converged results.

A variety of methods may be used to obtain physical structural loads from a solution of the modal equations of motion governing gust response. These include the Mode Displacement method, the Mode Acceleration method, and the Force Summation method. All three methods are capable of providing a balanced set of aeroplane loads. If an infinite number of modes can be considered in the analysis, the three will lead to essentially identical results.

The Mode Displacement method is the simplest. In this method, total dynamic loads are calculated from the structural deformations produced by the gust using modal superposition.

Specifically, the contribution of a given mode is equal to the product of the load associated with the normalised deformed shape of that mode and the value of the displacement response given by the associated modal co-ordinate. For converged results, the Mode Displacement method may need a significantly larger number of modal co-ordinates than the other two methods.

In the Mode Acceleration method, the dynamic load response is composed of a static part and a dynamic part. The static part is determined by conventional static analysis (including rigid body “inertia relief”), with the externally applied gust loads treated as static loads. The dynamic part is computed by the superposition of appropriate modal quantities, and is a function of the number of modes carried in the solution. The quantities to be superimposed involve both motion response forces and acceleration responses (thus giving this method its name). Since the static part is determined completely and independently of the number of normal modes carried, adequate accuracy may be achieved with fewer modes than would be needed in the Mode Displacement method.

The Force Summation method is the most laborious and the most intuitive. In this method, physical displacements, velocities and accelerations are first computed by superposition of the modal responses. These are then used to determine the physical inertia forces and other motion dependent forces. Finally, these forces are added to the externally applied forces to give the total dynamic loads acting on the structure.

If balanced aeroplane load distributions are needed from the discrete gust analysis, they may be determined using time correlated solution results. Similarly, as explained in Section 5.c of this ACJ, if balanced aeroplane load distributions are needed from the continuous turbulence analysis, they may be determined from equiprobable solution results obtained using cross-correlation coefficients.

8. NONLINEAR CONSIDERATIONS

- a. General. Any structural, aerodynamic or automatic control system characteristic which may cause aeroplane response to discrete gusts or continuous turbulence to become non-linear with respect to intensity or shape should be represented realistically or conservatively in the calculation of loads. While many minor non-linearities are amenable to a conservative linear solution, the effect of major non-linearities cannot usually be quantified without explicit calculation.

The effect of non-linearities should be investigated above limit conditions to assure that the system presents no anomaly compared to behaviour below limit conditions, in accordance with JAR 25.302 Appendix K(b)(2).

- b. Structural and Aerodynamic Non-linearity. A linear elastic structural model, and a linear (unstalled) aerodynamic model are normally recommended as conservative and acceptable for the unaugmented aeroplane elements of a loads calculation. Aerodynamic models may be refined to take account of minor non-linear variation of aerodynamic distributions, due to local separation etc., through simple linear piecewise solution. Local or complete stall of a lifting surface would constitute a major non-linearity and should not be represented without account being taken of the influence of rate of change of incidence, i.e., the so-called ‘dynamic stall’ in which the range of linear incremental aerodynamics may extend significantly beyond the static stall incidence.
- c. Automatic Control System Non-linearity. Automatic flight control systems, autopilots, stability control systems and load alleviation systems often constitute the primary source of non-linear response. For example,
- non-proportional feedback gains
 - rate and amplitude limiters
 - changes in the control laws, or control law switching
 - hysteresis
 - use of one-sided aerodynamic controls such as spoilers
 - hinge moment performance and saturation of aerodynamic control actuators

The resulting influences on response will be aeroplane design dependent, and the manner in which they are to be considered will normally have to be assessed for each design.

Minor influences such as occasional clipping of response due to rate or amplitude limitations, where it is symmetric about the stabilised 1-g condition, can often be represented through quasi-linear modelling techniques such as describing functions or use of a linear equivalent gain.

Major and unsymmetrical influences such as application of spoilers for load alleviation, normally require explicit simulation, and therefore adoption of an appropriate solution based in the time domain.

The influence of non-linearities on one load quantity often runs contrary to the influence on other load quantities. For example, an aileron used for load alleviation may simultaneously relieve wing bending moment whilst increasing wing torsion. Since it may not be possible to represent such features conservatively with a single aeroplane model, it may be conservatively acceptable to consider loads computed for two (possibly linear) representations which bound the realistic condition. Another example of this approach would be separate representation of continuous turbulence response for the two control law states to cover a situation where the aeroplane may occasionally switch from one state to another.

- d. Non-linear Solution Methodology. Where explicit simulation of non-linearities is required, the loads response may be calculated through time domain integration of the equations of motion.

For the tuned discrete gust conditions of JAR 25.341(a), limit loads should be identified by peak values in the non-linear time domain simulation response of the aeroplane model excited by the discrete gust model described in Section 5.b. of this ACJ.

For time domain solution of the continuous turbulence conditions of JAR 25.341(b), a variety of approaches may be taken for the specification of the turbulence input time history and the mechanism for identifying limit loads from the resulting responses.

It will normally be necessary to justify that the selected approach provides an equivalent level of safety as a conventional linear analysis and is appropriate to handle the types of non-linearity on the aircraft. This should include verification that the approach provides adequate statistical significance in the loads results.

A methodology based upon stochastic simulation has been found to be acceptable for load alleviation and flight control system non-linearities. In this simulation, the input is a long, Gaussian, pseudo-random turbulence stream conforming to a von Karman spectrum with a root-mean-square (RMS) amplitude of 0.4 times U_s (defined in Section 5.C.1 of this ACJ).

The value of limit load is that load with the same probability of exceedance as $\bar{A}U_\sigma$ of the same load quantity in a linear model. This is illustrated graphically in Figure 5. When using an analysis of this type, exceedance curves should be constructed using incremental load values up, or just beyond the limit load value.

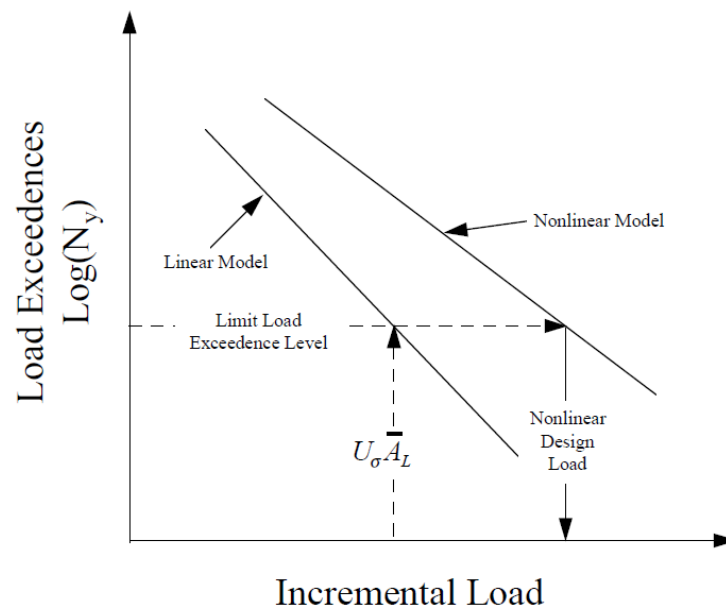

Figure-5 Establishing Limit Load for a Non-linear Aeroplane

The non-linear simulation may also be performed in the frequency domain if the frequency domain method is shown to produce conservative results. Frequency domain methods include, but are not limited to, Matched Filter Theory and Equivalent Linearization.

9. ANALYTICAL MODEL VALIDATION

- a. General. The intent of analytical model validation is to establish that the analytical model is adequate for the prediction of gust response loads. The following sections discuss acceptable but not the only methods of validating the analytical model. In general, it is not intended that specific testing be required to validate the dynamic gust loads model.
- b. Structural Dynamic Model Validation. The methods and test data used to validate the flutter analysis models presented in ACJ 25.629 should also be applied to validate the gust analysis models. These procedures are addressed in ACJ 25.629.
- c. Damping Model Validation. In the absence of better information it will normally be acceptable to assume 0.03 (i.e. 1.5% equivalent critical viscous damping) for all flexible modes. Structural damping may be increased over the 0.03 value to be consistent with the high structural response levels caused by extreme gust intensity, provided justification is given.
- d. Aerodynamic Model Validation. Aerodynamic modelling parameters fall into two categories:
 - (i) steady or quasisteady aerodynamics governing static aeroelastic and flight dynamic airload distributions
 - (ii) unsteady aerodynamics which interact with the flexible modes of the aeroplane.

Flight stability aerodynamic distributions and derivatives may be validated by wind tunnel tests, detailed aerodynamic modelling methods (such as CFD) or flight test data. If detailed analysis or testing reveals that flight dynamic characteristics of the aeroplane differ

significantly from those to which the gust response model have been matched, then the implications on gust loads should be investigated.

The analytical and experimental methods presented in ACJ 25.629 for flutter analyses provide acceptable means for establishing reliable unsteady aerodynamic characteristics both for motion response and gust excitation aerodynamic force distributions. The aeroelastic implications on aeroplane flight dynamic stability should also be assessed.

- e. Control System Validation. If the aeroplane mathematical model used for gust analysis contains a representation of any feedback control system, then this segment of the model should be validated. The level of validation that should be performed depends on the complexity of the system and the particular aeroplane response parameter being controlled. Systems which control elastic modes of the aeroplane may require more validation than those which control the aeroplane rigid body response. Validation of elements of the control system (sensors, actuators, anti-aliasing filters, control laws, etc.) which have a minimal effect on the output load and response quantities under consideration can be neglected.

It will normally be more convenient to substantiate elements of the control system independently, i.e. open loop, before undertaking the validation of the closed loop system.

- (1) System Rig or Aeroplane Ground Testing. Response of the system to artificial stimuli can be measured to verify the following:
- The transfer functions of the sensors and any pre-control system antialiasing or other filtering.
 - The sampling delays of acquiring data into the control system.
 - The behaviour of the control law itself.
 - Any control system output delay and filter transfer function.
 - The transfer functions of the actuators, and any features of actuation system performance characteristics that may influence the actuator response to the maximum demands that might arise in turbulence; e.g. maximum rate of deployment, actuator hinge moment capability, etc.

If this testing is performed, it is recommended that following any adaptation of the model to reflect this information, the complete feedback path be validated (open loop) against measurements taken from the rig or ground tests.

- (2) Flight Testing. The functionality and performance of any feedback control system can also be validated by direct comparison of the analytical model and measurement for input stimuli. If this testing is performed, input stimuli should be selected such that they exercise the features of the control system and the interaction with the aeroplane that are significant in the use of the mathematical model for gust load analysis. These might include:
- Aeroplane response to pitching and yawing manoeuvre demands.
 - Control system and aeroplane response to sudden artificially introduced demands such as pulses and steps.
 - Gain and phase margins determined using data acquired within the flutter test program. These gain and phase margins can be generated by passing known signals through the open loop system during flight test.

– END –

SPECIAL CONDITION	CCD-01 SC: Operational Suitability Data (OSD) - Cabin Crew Data (CCD)
APPLICABILITY:	A380
REQUIREMENTS:	Regulation (EU) 748/2012 of 03rd August 2012, as amended
ADVISORY MATERIAL:	Present Certification Review Item establishing the certification basis for the grandfathered A380-800 Cabin Crew Operational Suitability Data

BACKGROUND

In December 2001, Airbus applied for the type certification of their A380-800.

The A380-800 was type certificated by EASA in December 2006.

In September 2002, Airbus applied to JAA, for an Operational Evaluation Board process, including the operational evaluation of the Cabin Crew domain (A380-800 JOEB CC evaluation).

The Joint Aviation Authorities (JAA)/EASA completed the cabin crew operational evaluation of the A380-800 in August 2007.

A Joint Operational Evaluation Board (JOEB) report compiling the conclusions of the cabin crew evaluation, was published by EASA under the title: “Joint Operational Evaluation Board- A380-800 Cabin Crew Report, Issue 01, dated 22 August 2007”.

With the adoption of the Commission Regulation (EU) No. 69/2014 amending Regulation (EU) No. 748/2012 laying down implementing rules for the airworthiness and environmental certification of aircraft and related products, parts and appliances, as well as for the certification of design and production organisations, as per Article 7a, para. 3, “*Operational Evaluation Board reports... issued in accordance with JAA procedures or by the Agency before the entry into force of this Regulation shall be deemed to constitute the operational suitability data approved in accordance with point 21.A.21(e) of Annex I (Part 211) and shall be included in the relevant type-certificate. ...*”

In accordance with Part 21, 21.A.16A “*The Agency shall issue in accordance with Article 19 of Regulation (EC) No 216/2008 certification specifications, including certification specifications for operational suitability data, as standard means to demonstrate compliance of products, parts and appliances with the relevant essential requirements of Annex I, III and IV to Regulation (EC) No 216/2008. Such specifications shall be sufficiently detailed and specific to indicate to applicants the conditions under which certificates will be issued, amended or supplemented*”;

In accordance with Part 21, 21.A.17B(a) “*...The Agency shall notify to the applicant the operational suitability data certification basis. It shall consist of ... the applicable certification specifications for operational suitability data issued in accordance with point 21.A.16A that are effective on the date of application or application supplement ...*”

The purpose of this CRI is to establish the certification basis for the grandfathered A380 Cabin Crew Operational Suitability Data.

There were no applicable certification specifications for operational suitability data issued in accordance with point 21.A.16A, effective on the date of the Type Certificate application for the A380-800.

In accordance with Part 21, 21.A.17B(a), the operational suitability data certification basis needs to be defined for the A380-800 Cabin Crew Data transferred from the A380 JOEB Cabin Crew Report.

The purpose of the A380 JOEB CC evaluation, as requested by Airbus in September 2002, was to:

- establish that the A380-800 is a new aircraft type for cabin crew training and operations (as per JAR-OPS 1.1030- Operation on more than one type or variant);
- provide recommendations to support the establishment of cabin crew training programs by operators (as per JAR-OPS 1.1010 – Conversion and differences training).

SPECIAL CONDITION

Having regard of the applicable JAR-OPS requirements, and in accordance with "Part 3-Procedure Document for Joint Operational Evaluation Board (JOEB)-Cabin Crew, Version 4, dated 19 July 2006", which governed the A380-800 JOEB CC evaluation, the following aircraft type specific elements that would impact normal and/or emergency operations for cabin crew were assessed in order to support the evaluation outcome:

- aircraft configuration
 - number of aisles
 - number of passenger decks;
- doors and exits
 - exit arming/disarming
 - direction of movement of the operating handle
 - direction of exit opening
 - power assist mechanism

Note: In accordance with JAR-OPS 1.1030/EU-OPS 1.1030 and later on with ORO.CC.250, self-help exits, for example Type III and Type IV exits, need not to be included in the determination of new type or variant.

- assisting evacuation means;
- aircraft systems for cabin crew duties
 - emergency lighting system;
 - smoke detection system and smoke barrier;
 - built-in fire extinguishing system;
 - drop-down oxygen system;
 - communication and public address system;
 - control and indication panels.

The outcome of the A380 JOEB CC evaluation confirmed that the A380-800 is a new aircraft type for cabin crew, as documented by Airbus in their application, and that cabin crew type specific training would be required at the operator level, when transferring to and from the A380-800 (as per JAR-OPS 1.1010-Conversion and differences training, and later on, in accordance with EU-OPS 1.1010 and ORO CC.125).

In order to support the development by operators of the A380-800 cabin crew type specific training, the JAA Team provided training recommendations, as captured in the "Joint Operational Evaluation Board- A380-800 Cabin Crew Report, Issue 01, dated 22 August 2007", and addressing the following:

- Aircraft type specific elements identified during the cabin certification process:

- number and composition of cabin crew;
- senior cabin crew member;
- information identified during emergency evacuation demonstration (e.g. crowd control, use of stair);
- slide raft portability;
- cabin crew direct view and identification of cabin crew seats to be occupied;
- passenger briefing.

In addition to the transfer of the A380-800 OEB CC Report to A380-800 Cabin Crew Operational Suitability Data compliance documentation, and in response to the Commission Regulation No 69/2014, Airbus and EASA have agreed on the Airbus proposed division of the operational suitability data in mandatory data (**M**) and non-mandatory data (**AMC** = Acceptable Means of Compliance), as highlighted in the compliance documentation.

As per the Commission Regulation (EU) No 69/2014, Article 7a, para.3, the elements identified in accordance with the JAA/EASA procedures (described above), shall be included in the relevant type certificate and shall be deemed to constitute the A380 cabin crew operational suitability data, approved in accordance with this CRI.

– END –

SPECIAL CONDITION	D-03 SC: Emergency exit arrangement - outside viewing
APPLICABILITY:	A380
REQUIREMENTS:	JAR 25.809 (a)
ADVISORY MATERIAL:	N/A

BACKGROUND

Emergency evacuations may be associated to adverse conditions such as a fire outside the aeroplane. Because the hazard may pose an immediate threat to the occupants of the aeroplane, it is often necessary to avoid opening certain otherwise usable emergency exits, to prevent injury to the evacuees.

In this context, a viewing window or other means of assessing the outside conditions and determining whether an exit should be opened is extremely valuable. The Very Large Transport Aeroplane Conference (Noordwijkerhout, The Netherlands, 13-16 October 1998) specifically recommends that the issue of outside view for evacuation be taken into account for future VLTA design.

Special Condition D-3, based on a set of requirements proposed in NPRM 96-9 (FAA Docket N°28637), addresses the concerns raised by VLTA.

SPECIAL CONDITION

Revise 25.809(a) to read:

« (a) Each emergency exit, including a flight crew emergency exit, must be a movable door or hatch in the external walls of the fuselage, allowing unobstructed opening to the outside. In addition, each emergency exit must have means to permit viewing of the conditions outside the exit when the exit is closed. The viewing means may be on the exit, or adjacent to it provided no obstructions exist between the exit and the viewing means. Means must also be provided to permit viewing of the likely areas of evacuee ground contact. The likely areas of evacuee ground contact must be viewable with the landing gear extended as well as in all conditions of landing gear collapse.

Overwing exits may be exempted from this requirement provided there are viewing means allowing seeing whether the wing surface outside the exit is safe. »

– END –

SPECIAL CONDITION	D-04 SC: Crew Rest Compartments
APPLICABILITY:	A380
REQUIREMENTS:	JAR 21.16, 25.831, 25.812, 25.853, 25.858
ADVISORY MATERIAL:	N/A

BACKGROUND

Airbus offer in option the possibility to install Crew Rest Compartments (CRC) of different types and at different locations on the A380-800. Flight Crew Rest Compartments (FCRC) being occupied by flight crew members and Cabin Crew Rest Compartments (CCRC) being occupied by cabin crew members. Occupancy will be limited to crewmembers who are trained in the emergency procedures and in the use of emergency equipment and systems of the CRC.

The applicable airworthiness regulations do not contain adequate or appropriate safety standards for these design features. Special conditions are required for the certification of CRC to supplement JAR 25 at change 15.

SPECIAL CONDITION

- 1 CRC occupancy is not allowed during Taxi, Take-off and Landing (TT&L) phases except for the Flight Crew Rest Compartments where Special Condition 20 applies. During flight, occupancy of the CRC is limited to the total number of bunks and / or seats that are installed in the compartment.
 - (a) There must be appropriate placards, inside and outside each entrance to the CRC to indicate:
 - 1) *The maximum number of crewmembers allowed during flight and,*
 - 2) *That occupancy is restricted to operating crewmembers trained in the use of emergency equipment, emergency procedures and the systems of the CRC,*
 - 3) *That smoking is prohibited in the CRC,*
 - 4) *That the crew rest area is limited to the stowage of crew personal luggage and must not be used for the stowage of cargo or passenger baggage.*
 - (b) There must be at least one ashtray on the inside and outside of any entrance to the CRC.
 - (c) A limitation in the Airplane Flight Manual or other suitable means must be established to restrict occupancy to crewmembers and to specify the phases of flight occupancy that are allowed for each installed CRC.
 - (d) For each occupant permitted in the CRC, there must be an approved seat or berth that must be able to withstand the maximum flight loads when occupied.
- 2 For all doors installed, there must be a means to preclude anyone from being trapped inside the CRC. If a locking mechanism is installed, it must be capable of being unlocked from the outside without the aid of special tools. The lock must not prevent opening from the inside of the compartment at any time.
- 3 There must be at least two emergency evacuation routes, which could be used by each occupant of the CRC to rapidly evacuate to the passenger decks.
 - (a) The routes must be located with sufficient separation within the CRC, and between the evacuation routes, to minimize the possibility of an event, either inside or outside of the crew rest compartment, rendering both routes inoperative.

- (b) The routes must be designed to minimize the possibility of blockage, which might result from fire (inside or outside the CRC), mechanical or structural failure, or persons standing below or against crew rest exits doors or hatches. If there is low headroom at or near the evacuation route, provisions must be made to prevent or to protect occupants (of the CRC) from head injury. The use of evacuation routes must not be dependent on any powered device. If a crew rest exit route is in an area where there are passenger seats, a maximum of five passengers may be displaced from their seats temporarily during the evacuation process of an incapacitated person(s). If the evacuation procedure involves the evacuee stepping on seats, the seats must not be damaged to the extent that they would not be acceptable for occupancy during an emergency landing.
- (c) Emergency evacuation procedures, including the emergency evacuation of an incapacitated occupant from the CRC, must be established and demonstrated.
- (d) There must be a limitation in the Airplane Flight Manual or other suitable means requiring that crewmembers be trained in the use of evacuation routes.
- (e) There must be a means to prevent passengers on the passenger decks from entering the CRC in the event of an emergency, including an emergency evacuation, or when no flight attendant is present.
- (f) The means of opening CRC doors and hatches must be simple and obvious. In addition, the CRC doors and hatches must be able to be closed from outside.
- (g) It must be shown by actual demonstration that the maximum allowed number of CRC occupants can easily evacuate the CRC using the main access route. This demonstration must also be performed using the alternate evacuation route.

The secondary evacuation route is not required for CRC located at a passenger deck level and when:

- The CRC is a small room designed for only one occupant for short time duration, such as a changing area or lavatory or
- It can be shown that no one can be trapped in the CRC due to fire (inside or outside the CRC), mechanical or structural failure.

4 The evacuation of an incapacitated person (representative of a ninety-fifth percentile male in size, at the corresponding weight) must be demonstrated for all evacuation routes. The number of crewmembers, which may provide assistance in the evacuation from inside, are limited by the available space. Additional assistance may be provided by up to three persons in the passenger compartment.

5 The following signs and placards must be provided in the CRC:

- (a) At least one exit sign, located near each crew rest door or hatch, meeting the requirements of JAR 25.812(b)(1)(i),
- (b) An appropriate placard located conspicuously on or near each crew rest emergency exit door or hatch that defines the location and the operating instructions for each evacuation route.
- (c) Placards must be readable from a distance of 30 inches under emergency lighting conditions.
- (d) The door or hatch handles and evacuation path operating instruction placards must be illuminated to at least 160 microlamberts under emergency lighting conditions.

The above requirements may be subject to specific evaluation and possibly to a finding of equivalent level of safety.

- 6 There must be a means in the event of failure of the aircraft's main power system, or of the normal CRC lighting system, for emergency illumination to be automatically provided for the CRC.
 - (a) This emergency illumination must be independent of the main lighting system.
 - (b) The sources of general cabin illumination may be common to both the emergency and the main lighting systems if the power supply to the emergency lighting system is independent of the power supply to the main lighting system.
 - (c) The illumination level must be sufficient for the occupants of the CRC to locate and transfer to the passenger cabin by means of each evacuation route.
 - (d) The illumination level must be sufficient, with the privacy curtains in the closed position, for each occupant of the crew rest to locate a deployed oxygen mask.
- 7 There must be means for two-way voice communications between crewmembers on the flight deck and occupants of the CRC. There must also be two-way communications between the occupants of the CRC and each flight attendant station required to have a public address system microphone per JAR 25.1423(g) in the passenger cabin. In addition, the public address system must include provisions to provide only the relevant information to the crewmembers in the CRC (e.g., fire in flight, aircraft depressurization, etc.). That is, provisions must be provided so that occupants of the CRC will not be disturbed with normal, non-emergency announcements made to the passenger cabin.
- 8 There must be a means for manual activation of an aural emergency alarm system, audible during normal and emergency conditions, to enable crewmembers on the flight deck and at each pair of required floor level emergency exits to alert occupants of the CRC of an emergency situation. Use of a public address or crew interphone system will be acceptable, provided an adequate means of differentiating between normal and emergency communications is incorporated. The system must be powered in flight, after the shutdown or failure of all engines and auxiliary power units (APU), for a period of at least ten minutes.
- 9 There must be a means, readily detectable by seated or standing occupants of the CRC, which indicates when seat belts should be fastened. Seat belt type restraints must be provided for berths and must be compatible for the sleeping attitude during cruise conditions. There must be a placard on each berth requiring that these restraints be fastened when occupied. If compliance with any of the other requirements of these special conditions is predicated on specific head location, there must be a placard identifying the head position.
- 10 Means must be provided to cover turbulence. If the seat backs do not provide a firm handhold, or if there is no seat installed, there must be a handgrip or rail to enable persons to steady themselves while in the CRC, in moderately rough air.
- 11 The following safety equipment must also be provided in the CRC:
 - (a) At least one approved hand-held fire extinguisher appropriate for the kinds of fires likely to occur,
 - (b) One Portable Protective Breathing Equipment (PBE) devices approved to European Technical Standard Order (ETSO)-C116 or equivalent and meeting JAR 25.1439, closed to each hand-held fire extinguisher
 - (c) One flashlight

- 12 A smoke or fire detection system (or systems) must be provided that monitors each occupiable area within the CRC, including those areas partitioned by curtains. Each system (or systems) must provide:
 - (a) A visual indication to the flight crew within one minute after the start of a fire;
 - (b) An aural warning in the CRC, and
 - (c) A warning in the passenger decks. This warning must be readily detectable by a flight attendant, taking into consideration the positioning of flight attendants throughout the passenger compartment during various phases of flight.

- 13 A means to fight and suppress a fire when the CRC is not occupied must be provided. This means can either be a built-in extinguishing system or manual hand held bottle extinguishing system.
 - (a) The design shall be such that any fire within the compartment can be controlled without entering the compartment or the design of the access provisions must allow crewmembers equipped for fire fighting to have unrestricted access to the compartment.
 - (b) If a built-in fire extinguishing system is used in lieu of manual fire fighting, the system must have adequate capacity to suppress any fire occurring in the crew rest compartment, considering the fire threat, volume of the compartment, the ventilation rate and the minimum performance standards (MPS) that have been established for the agent being used. In addition it must be shown that a fire will be contained within a controlled volume meeting the requirements of Appendix F, Part III.
 - (c) The fire fighting procedures must describe the methods to search the crew rests for fire sources(s). Training and procedures must be demonstrated by test and documented in the suitable manuals.
 - (d) The time for a crewmember on the passenger deck to react to the fire alarm, to don the fire fighting equipment and to gain access to the crew rest compartment must not exceed the time for the compartment to become smoke-filled, making it difficult to locate the fire source.
 - (e) The in-flight accessibility of large enclosed stowage compartments and the subsequent impact on the crewmembers' ability to effectively reach any part of the compartment with the contents of a hand fire extinguisher may require additional fire protection considerations similar to those required for inaccessible compartments such as Class C cargo compartments.

- 14 There must be a means provided to exclude hazardous quantities of smoke or extinguishing agent originating in the CRC from entering any other occupiable compartment.
 - (a) Small quantities of smoke may penetrate from the crew rest compartment into other occupied areas during the one-minute smoke detection time.
 - (b) When built in fire extinguishing systems are used, there must be a provision in the fire fighting procedures to ensure that all door(s) and hatch(es) at the crew rest compartment emergency exits are closed after evacuation of the crew rest and during fire fighting.
 - (c) Smoke entering any occupiable compartment when access to the CRC is open must dissipate within five minutes after the access to the CRC is closed.
 - (d) In the case of a CRC immediately adjacent to and on the same deck as passenger seated areas the smoke penetration requirements of (a) to (d)(c) above do not apply. However, it must be demonstrated that the complete fire detection and fire fighting procedure can be conducted effectively without causing a hazard to passengers due to excess quantities of smoke and / or extinguishing accumulating and remaining in occupied areas.

- 15 When a CRC is installed or enclosed as a removable module in part of a cargo compartment or located directly adjacent to a cargo compartment without an intervening cargo compartment wall, the following applies:
- Any wall of the module (container) forming part of the boundary of the reduced cargo compartment, subject to direct flame impingement from a fire in the cargo compartment and including any interface item between the module (container) and the airplane structure or systems, must meet the applicable requirements of JAR 25.855.
 - Means must be provided so that the fire protection level of the cargo compartment meets the applicable requirements of JAR 25.855, JAR 25.857 and JAR 25.858 when the module (container) is not installed.
 - Use of the emergency evacuation route must not require occupants of the CRC to enter the cargo compartment in order to return to the passenger compartment.
- 16 There must be a supplemental oxygen system equivalent to that provided for passenger decks for each seat and berth in the CRC (automatic drop down system with means by which the oxygen masks can be manually deployed from the flight deck). The system must provide an aural and visual warning to warn the occupants of the CRC to don oxygen masks in the event of decompression. The warning must activate before the cabin pressure altitude exceeds 15,000 feet. The aural warning must sound continuously for a minimum of five minutes or until a reset push button in the CRC is pressed. Procedures for crew rest occupants in the event of decompression must be established. These procedures must be transmitted to the operator for incorporation into their training programs and appropriate operational manuals.
- 17 The following requirements apply to CRC that are divided into several sections by the installation of curtains or partitions:
- To compensate for sleeping occupants, there must be an aural alert that can be heard in each section of the CRC that accompanies automatic presentation of supplemental oxygen masks. A visual indicator that occupants must don an oxygen mask is required in each section where seats or berths are not installed. A minimum of two supplemental oxygen masks are required for each seat or berth.
 - A placard is required adjacent to each curtain that visually divides or separates, for privacy purposes, the CRC into small sections. The placard must require that the curtain(s) remains open when the private section it creates is unoccupied.
 - For each section of the CRC created by the installation of a curtain, the following requirements of these special conditions must be met with the curtain open or closed:
 - No smoking placard (Special Condition N°1),*
 - Emergency illumination (Special Condition N°6),*
 - Emergency alarm system (Special Condition N°8),*
 - Seat belt fasten signal or return to seat signal as applicable (Special Condition N°9), and*
 - The smoke or fire detection system (Special Condition N°12).*
 - CRC visually divided to the extent that evacuation could be affected must have exit signs that direct occupants to the primary evacuation route. The exit signs must be provided in each separate section of the CRC, except for curtained bunks, and must meet the requirements of JAR§ 25.812(b)(1)(i).
 - For sections within an CRC that are created by the installation of a partition with a door separating the sections, the following requirements of these special conditions must be met with the door open or closed:

- 1) There must be a secondary evacuation route from each section to the passenger decks, or alternatively, it must be shown that any door between the sections has been designed to preclude anyone from being trapped inside the compartment. Removal of an incapacitated occupant from within this area must be considered. A secondary evacuation route from a small room designed for only one occupant for short time duration, such as a changing area or lavatory, is not required. However, removal of an incapacitated occupant from within a small room, such as a changing area or lavatory, must be considered.
 - 2) Any door between the sections must be shown to be openable when crowded against, even when crowding occurs at each side of the door.
 - 3) There may be no more than one door between any seat or berth and the primary emergency exit.
 - 4) There must be exit signs in each section meeting the requirements of JAR § 25.812(b)(1)(i) that direct occupants to the primary stairway outlet. For single bed or small compartments reduced sizes might be acceptable.
 - 5) Special Conditions N°1 (no smoking placards), N°6 (emergency illumination), N°8 (emergency alarm system), N°9 (fasten seat belt signal or return to seat signal as applicable) and N°12 (smoke or fire detection system) must be met with the door open or closed.
 - 6) Special Conditions N°7 (two-way voice communication) and N°11 (emergency fire fighting and protective equipment) must be met independently for each separate section except for lavatories or other small areas that are not intended to be occupied for extended periods of time.
- 18 Materials, Seat cushions and mattresses must comply with the relevant requirements of § JAR 25.853.
- 19 The addition of a lavatory within the CRC would require the lavatory to meet the same requirements as those for a lavatory installed on the passenger decks except that JAR 25.854 (a) is replaced by the Special Condition N°12 for smoke detection.
- 20 Where a waste disposal receptacle is fitted, it must be equipped with an automatic fire extinguisher that meets the performance requirements of JAR 25.854(b).
- 21 The following additional requirements apply to Flight Crew Rest Compartments (FCRC) that may be occupied during Taxi, Take-off and Landing (TT&L):
- (a) During TT&L, occupancy of the FCRC is limited to the total number of installed seats approved to the flight / ground load conditions and emergency landing conditions. Doors installed across emergency egress routes must have a means to latch them in the open position. The latching means must be able to withstand the loads imposed upon it when the door is subjected to the ultimate inertia forces, relative to the surrounding structure, listed in JAR 25.561(b).
 - (b) Doors or hatches that separate the FCRC compartment from a passenger deck must not adversely affect evacuation of occupants (slowing evacuation by encroaching into aisles, for example) or cause injury to those occupants during opening or while open.
 - (c) A placard must be displayed in a conspicuous place on the crew rest entrance door and any other door(s) installed across emergency egress routes of the crew rest, that requires these doors to be latched open during TT&L when the crew rest is occupied.
 - (d) An assessment must be done on design features affecting access to the evacuation routes. The design features that should be considered include, but are not limited to, seat deformations in accordance with 25.561(d) and 25.562(c)(8), seat back break

over, the elimination of rigid structure that reduces access from one part of the compartment to another, the elimination of items that are known to be the cause of potential hazards, supplemental restraint devices to retain items of mass that could hinder evacuation if broken loose and load path isolation between components that contain the evacuation routes.

- (e) There must be a limitation in the Airplane Flight Manual or other suitable means requiring that crewmembers be trained in the use of evacuation routes. This training must instruct them to ensure that the crew rest (i.e., seats, doors, etc.) is in its proper TT&L configuration. The limitation must furthermore restrict occupancy to flight crewmembers who the pilot in command has determined are able to rapidly use the evacuation routes. Placards inside and outside the FCRC must be provided accordingly.

Note: The Cabin Crew Rest Compartments (CCRC) shall not be occupied for Taxi, Tack off and Landing.

– END –

SPECIAL CONDITION and IM	D-06 SC &IM: Use of the stairs between decks
APPLICABILITY:	A380
REQUIREMENTS:	JAR 21.16, 25.811, 25.812, 25.813
ADVISORY MATERIAL:	N/A

BACKGROUND

The A380-800 design offers seating capacity on two separate decks: the main deck with a maximum passenger capacity of 542 and the upper deck with a maximum passenger capacity of 308. The movement of persons between decks is achieved with two stair cases, one located in the front and one in the rear portion of the cabin.

The Very Large Transport Aeroplane Conference (Noordwijkerhout, The Netherlands, 13-16 October 1998) addresses the issue of deck intercommunication in case of emergency with the following recommendation:

« In operation, whatever the configuration of the proposed VLTA, for evacuation purposes, it should be treated as a single vessel. However, for certification purposes, it may be necessary to consider multiple decks as either independent or interrelated in demonstrating compliance with requirements on evacuation, dependent on the scenario to be considered. »

With the following rationale:

« To consider the aeroplane as a single vessel is essential in particular when the cabin crew has to co-ordinate action for an efficient evacuation. Alternate routes may be considered, e.g. the use of the upper deck exits (or lower deck exits) by occupants seated on the other deck when deemed appropriate.

However, the certification exercise may require considering each deck of a multiple-deck aeroplane as an independent deck, asking for the usual capability for evacuation of each deck (taking into account the specificity of each deck, e.g. higher sill, longer slides). »

The installation of an upper deck passenger compartment with a maximum seating capacity of 308 passengers and two stairways between passenger decks constitutes a novel and unusual design feature for an aeroplane certified under JAR 25 and the applicable airworthiness requirements do not contain adequate or appropriate safety standards. Special Conditions are necessary to ensure a level of safety equivalent to that established in the applicable JAR.

SPECIAL CONDITION

- (a) There must be at least two stairways adequately distributed, in order to provide deck to deck connection.
- (b) At least one stairway between decks must meet the following requirements:
 - 1- It must accommodate the carriage of an incapacitated person from one deck to the other. The crew member procedures for such a carriage must be established.
 - 2- It must provide evacuees an adequate rate, for going down or going up, under probable emergency conditions, including a condition in which a person falls or is incapacitated while on it.
- (c) In addition each stairways between decks must meet the following requirements :
 - 1- It must have entrance, exit, and gradient characteristics that would allow, with the aeroplane in level attitude and in each attitude resulting from the collapse of any one or

more legs of the landing gear, the passengers of one deck, with the assistance of a crew member, to merge with passengers of the other deck during an evacuation and exit the aeroplane. This must be demonstrated by tests and / or analysis.

- 2- It shall have a handrail on at least one side in order to allow people to steady themselves during foreseeable conditions, including but not limited to, gear collapse conditions on ground and moderate turbulence in flight. The handrails shall be constructed so that there will be no obstruction on them which will break a hand hold or hinder the continuous movement of the hands. Handrails shall be terminated in a manner which will not obstruct pedestrian travel or create a hazard. Adequacy of the design will be demonstrated by using representatives of 5% female and 95 % male.
- 3- It must be designed and located to minimise damage to it during an emergency landing or ditching.
- 4- It shall have a wall or equivalent on each side in order to minimise the risk of falling in it and to facilitate its use under conditions of abnormal a/c attitude.
- 5- Treads and landings shall be designed and demonstrated to be free of hazard. The landing area at each deck level shall be demonstrated to be adequate, in terms of flow rate, for the expected maximum number of people that will be using the stair in an emergency. Treads and risers shall be designed to ensure an easy and safe use of the stairway.
- 6- General emergency illumination must be provided. So that, when measured along the centre lines of each tread and landing, the illumination is not less than 0.05 foot-candle.
- 7- In normal operation, general illumination level must not be less than the level required in (c)(6) above for emergency conditions. The Assessment should be done under day light and dark night conditions.
- 8- Both stairway ends must be indicated by an exit sign visible to passengers when in the stairway. This exit sign must meet 25.812(b)(1)(ii).
- 9- A floor proximity path marking system compliant with 25.812(e) must be available to guide passengers in the stairway to the stairway ends. It shall not direct the occupants of the cabin to the stair entrance.
- 10- The public address system should be audible in the stairway during all flight phases.
- 11- Non-smoking and return to seat signs should be installed and be visible in the stairway both going up and down and at the stairway entrances.

(d) Cabin crew procedures and positions have to be established to control the use of the stairs on ground and in flight, in normal and in emergency situations. This may dictate a need for cabin crew members to have specific dedicated duties for the control of the stairs during emergency and precautionary evacuations. Cabin crew procedures will need to be defined.

(e) It should not be hazardous for crew members or passengers having to return to their seats to use the stairways in moderate turbulence.

INTERPRETATIVE MATERIAL

IM (c)(1)

Typically the width of the staircase should not be less than 900mm and the headroom above each step shall have a minimum of 2000 mm.

IM (c)(5)

Among other safety features, slip-resistant finish should be used in that respect.

For treads and risers, unless other values are shown to be acceptable, a vertically projected tread depth of not less than 230 mm should be used.

– END –

SPECIAL CONDITION and IM	D-07 SC & IM: Fire detection and protection in passenger cabin
APPLICABILITY:	A380
REQUIREMENTS:	25.853, 25.854, 25.855, 25.857, 25.858
ADVISORY MATERIAL:	N/A

BACKGROUND

The A380 design offers seating capacity on two separate decks: the main deck with a maximum passenger capacity of 542 and the upper deck with a maximum passenger capacity of 308. Associated to this higher passenger capacity compared to currently certified aircraft, the A380 will feature more stowage compartments and higher stowage capacity. It is not intended, however, to offer more stowage space per passenger, when compared to recently delivered aircraft. A380 commercial cabin installation may also feature electrical systems with higher installed power (passenger entertainment systems, galleys, trolley lift system, in-seat power supplies), to cope with the higher passenger capacity and novel features such as recreation areas, office/business installations, etc... which may be offered to operators after type certification.

The Very Large Transport Aeroplane (VLTA) Conference (Noordwijkerhout, The Netherlands, 13-16 October 1998) addresses the issue of fire protection.

A special condition is necessary to address the VLTA recommendations and to make sure that the current transport aircraft good service experience with respect to cabin in-flight fire in accessible areas will be maintained on the A380.

Service experience of fire in inaccessible areas indicate the need for special precautions. Stowage compartments and electrical equipment in the cabin are considered to be potential fire sources.

In addition, the A380 double deck configuration will offer airlines an increased flexibility to choose cabin layouts with a large number of partitions or with special use areas. This may increase the possibility of portions of the cabin left unattended during the cruise phase of flight. Taking into account

that the primary means for fire detection in passenger cabin and stowage compartments is direct detection by occupants (visual or smell) this may impact the level of safety.

SPECIAL CONDITION

1- Materials, equipment and systems in hidden area

Materials, equipment and systems in hidden area shall comply with the flammability requirements of JAR 25.853(a):

« JAR 25.853 Compartment interiors

- (a) Materials (including finishes or decorative surfaces applied to the materials) must meet the applicable test criteria prescribed in Part I of Appendix F or other approved equivalent methods.”

With the following definition of hidden areas: all areas, inaccessible in flight, located between the fuselage pressure shell and the passenger cabin “living space”, excluding cargo compartments complying with class C, D, or E.

2- Additional design precautions linked to A380 specific design feature:

JAA considers that the following design precautions shall be taken to ensure that the A380 features at least the same level of safety as existing aircraft, with regards to fire protection:

- 2.1 There shall be means to control ventilation and draughts in the cabin, so that smoke originating from one deck is unlikely to propagate to the other deck. Means shall be provided at the stairway to retard the propagation of fire and the transmission of smoke between the passenger decks in case of an in-flight fire scenario. This shall be demonstrated by test and / or analysis.
- 2.2 In all isolated compartments which may be closed off or isolated in flight (galley, IFE, trolley lift systems, compartment located in a non-permanently occupied area ...) fire detection systems compliant with JAR 25.858 or an equivalent means providing the same level of safety shall be installed. In addition, applications for installation of any isolated or special use area in the cabin (recreation area, lavatories compartment rest compartment, bar ...) will be reviewed by the JAA team to determine the need for dedicated special conditions or interpretative material.

INTERPRETATIVE MATERIAL

There are currently no JAR 25 paragraphs directly addressing the fire protection of cabin stowage compartments. Paragraphs 25.855, 25.857, 25.858 apply to cargo compartments, and have not been applied to passenger cabin stowage compartments in the past.

Current regulations do not contain specific requirements for passenger cabin stowage compartments fire protection because in the past, cabin interiors did allow for only limited volume of carry-on baggage, and passengers were expected to store their carry-on baggage directly above or nearby them. These practices limited the risk of potential fire sources being introduced in cabin stowage compartments, and allowed an early detection by the passengers in case of a fire initiation.

However, the recent years have seen a tendency to increase the amount of carry-on baggage, with associated cabin interior design changes (larger overhead bins, separate coats stowage compartments, remote crew stowage compartments, additional doghouses for stowage of bulky carry-on items...).

It is recognised that the A380 does not introduce a quantum leap in that evolution, however the size of the A380 leads to consider the risk of fire in cabin stowage compartments with particular attention.

The JAA consider that some design precautions need to be taken to ensure that the A380 will feature at least the same level of safety as currently certified aeroplanes, with regards to fire detection and protection in the passenger cabin.

In particular:

1. The following definition of cabin stowage compartment applies in this CRI:

A cabin stowage compartment is one in which:

- (1) The presence of a fire would be easily discovered by passengers or crew members
- (2) Each part of the compartment is easily accessible in flight

The volume and arrangement of a stowage compartment must be such that all portions of the compartment must be within arms length. Any compartment greater than 50 cubic feet

in volume would require particular attention to check that the above mentioned criteria are met.

2. The intent is that any fire likely to start in a cabin stowage compartment will be quickly detected and extinguished with hand held fire extinguishers before an hazardous situation can develop. In order to show compliance with this objective, it should be assessed by tests and / or analysis that any fire likely to start in a cabin stowage compartment can be easily and quickly detected by nearby occupants. In addition, it should be assessed that the fire can be contained within the stowage compartment, until it is detected and the cabin crew has time to access the compartment with firefighting equipment .This assessment should take into account the actual installation conditions of the stowage compartment (geometry, ventilation), and realistic fire source scenario.
3. Any other cabin baggage compartment which does not comply with the definition and requirements for cabin stowage compartments as defined above should be shown to comply with requirements applicable to cargo compartments, according to the cargo compartment classification provided in JAR 25.857

– END –

SPECIAL CONDITION and IM	D-12 SC & IM: Design for security
APPLICABILITY:	A380
REQUIREMENTS:	JAR 21.16, Amdt 97 of ICAO Annex 8
ADVISORY MATERIAL:	N/A

BACKGROUND

The threat to transport airplanes from unlawful acts depends on the opportunities that the airplane and its operational environment present, and the desirability of that airplane as a target.

In that respect, the A380 is of a particular interest because the largest aeroplane may be a target, and because the larger number of passengers boarding at the same time could potentially reduce the effectiveness of airport security measures. In addition, the increased size and passenger capacity of the A380 cabin could provide more opportunities for hiding dangerous objects, and could render searches more time consuming if not difficult.

In addition to the specific requirements regarding security in design requirements for large transport aeroplanes, resulting from Amendment 97 to ICAO Annex 8 (which became effective on March 12, 2000), the Design for Security Harmonisation Working Group has also accepted a task to address intrusion (by persons) resistance of the flight deck door. It is the intent of this requirement to prevent unauthorised entry into the flight deck by persons, who exert moderate force on the flight deck door. It is not the intent of this requirement to make the flight deck impenetrable.

It is recognised that non-compliance to ICAO Annex 8 Amendment 97 will probably be accepted on most transport aeroplanes until the Design for Security Harmonisation Work Group proposals are finalised and implemented in FAR/JAR 25 through the normal NPA/NPRM process. However, for the reasons explained above, the JAA team considered that the A380 is a particularly “desirable” target for unlawful acts, and that a Special Condition is necessary. It was proposed to adopt the current ARAC working group proposal.

SPECIAL CONDITION

A. Paragraph 25.772, revise the introductory language and paragraph (a) and add a new paragraph (c) to read as follows:

JAR 25.772 Pilot compartment doors.

For an aeroplane that has a lockable door installed between the pilot compartment and the passenger compartment:

- (a) For aeroplanes with a maximum passenger seating configuration of more than 20 seats, the emergency exit configuration must be designed so that neither crewmembers nor passengers require use of the flight deck door in order to reach the emergency exits provided for them; and

* * * * *

- (c) There must be an emergency means to enable a flight attendant to enter the pilot compartment in the event that the flight crew becomes incapacitated.

B. Paragraph 25.795, new

JAR 25.795 Security considerations

- a) Protection of flight deck. The flight crew compartment, including bulkheads, doors, and any other barriers separating it from occupied areas, must be designed to:
- (1) Resist forcible intrusion by unauthorised persons and be capable of withstanding impacts of 300 Joules (221.3 foot-pounds) at the critical locations of likely impact, as well as a 1113 Newton (250 pound) constant tensile load on the door knob or handle, and
 - (2) Resist penetration by small arms fire and fragmentation devices by meeting the following projectile definitions and projectile speeds:
 - (i) Demonstration Projectile #1. A 9 mm full metal jacket, round nose (FMJ RN) bullet with nominal mass of 8.0 g (124 grain) and reference velocity 436 m/s (1,430 ft/s)
 - (ii) Demonstration Projectile #2. A .44 Magnum, jacketed hollow point (JHP) bullet with nominal mass of 15.6 g (240 grain) and reference velocity 436 m/s (1,430 ft/s)
- b) Protection of flight crew compartment (smoke and fumes). Means must be provided to minimise entry into the flight crew compartment of smoke, fumes and noxious vapours generated by an explosion or fire on the aeroplane.
- c) Cabin smokes extraction. Design precautions must be taken to protect against possible instances of cabin depressurisation and against the presence of smoke or other toxic gases, including those caused by explosive or incendiary devices, which could incapacitate the occupants of the aeroplane.
- d) Least Risk Bomb Location. A least-risk bomb location on the aeroplane must be established where a bomb or other explosive device may be placed to minimise the effects on the aeroplane in the case of detonation. Consideration must be given during the design of the aeroplane to the provision of a least-risk bomb location.
- e) Fire suppression. Cargo compartment fire suppression systems, including their extinguishing agents, must be designed so as to take into account a sudden and extensive fire such as could be caused by an explosive or incendiary device.
- f) Survivability of systems. Aeroplane systems must be designed, arranged and physically separated to maximise the potential for continued safe flight and landing after any event resulting in damage to the aeroplane structure or system.
- g) Interior design to facilitate searches. Practical design features must be incorporated which will deter the easy concealment of weapons, explosives or other dangerous objects on board the aeroplane and which will facilitate search procedures for such objects. The following should be considered:
1. Life preservers should be stored in a manner such that tampering is obvious.
 2. Seat back pockets should be designed so that they can be easily checked for suspicious objects.
 3. Seat cushions should be easily removable and easily checkable.
 4. Locks or seals for Galley and lavatory access doors or panels.
 5. Overhead stowage compartments should be designed so that contents can be observed by a person standing in the aisle.
 6. Crew rest areas should be secured or be easily searchable.
 7. Exposed fasteners on panels in lavatories should not be easily removable with standard tools.
 7. Toilets should be designed to impede the introduction of dangerous objects.
 8. Stowage compartments (including galleys, closets etc.) should be readily searchable.

INTERPRETATIVE MATERIAL

ACJ 25-795-1, Flight deck intrusion resistance.
Referenced documentation: - FAA AC 25.795-1.

ACJ 25-795-2, Flight deck penetration resistance
Referenced documentation: - FAA AC 25.795-2.
- Level IIIA of the (US) National Institute of Justice
Standard (NIJ) 0101.04.

Draft FAA AC 25-795 b1 Protection of flight crew compartment (smoke and fumes)

Draft FAA AC 25-795 b2 Passenger Cabin Smoke Evacuation

Draft FAA AC 25-795 b3 Cargo Compartment Fire Suppression

Draft FAA AC 25-795 c Least Risk Bomb Location

Draft FAA AC 25-795 d Survivability of System

Draft FAA AC 25-795 e Design for ease of search

Note: FAA AC 25.795-1 and FAA AC 25.795-2 have been developed for application in the cockpit door only, but they are considered to provide useful guidance for intrusion and penetration resistance of the bulkhead. Details of the acceptable means of compliance of the bulkhead and any other barriers separating it from occupied areas will have to be proposed by Airbus in the appropriate certification plan and will be reviewed for agreement by the JAA team.

– END –

SPECIAL CONDITION	D-13 SC: Fire protection of thermal and acoustic insulation material
APPLICABILITY:	A380
REQUIREMENTS:	JAR 21.16, 25.853
ADVISORY MATERIAL:	N/A

BACKGROUND

The current flammability requirement focus on materials located in occupied compartments (JAR 25.853) and cargo compartments (JAR 25.855). The regulations pertaining to thermal/acoustic insulation address neither the thermal nor acoustic performance aspects, but the materials' tendency to propagate flame.

The JAA considers that there is a need to define a special condition because the airworthiness requirements of the relevant JAR do not contain adequate or appropriate safety standards for product, which in service Experience has shown that unsafe conditions may develop. However, based on the comments made on the proposed NPRM [docket N° FAA 2000-79092, notice N° 00-09] "Improved Flammability Standards for Thermal/Acoustic Insulation Materials Used in Transport Category Aeroplanes", it is considered that the Flame Penetration requirement and the corresponding test method are not mature enough to be made mandatory through a Special Condition.

The safety benefit to meet the Flame Penetration criteria is recognised by the aviation community and since there are materials currently available that will meet the proposed standards, JAA recommend that insulation materials (including the means of fastening the materials to the fuselage) installed in the lower half of the airplane fuselage meet the flame penetration resistance test requirements of the proposed part VII of appendix F in appendix of this CRI, or other equivalent test requirements.

SPECIAL CONDITION

Amend JAR 25.853(a), JAR 25.855(d) and define a new requirement JAR 25.856 as follows:

“ JAR 25.853 Compartment interiors.

- (a) Except for thermal/acoustic insulation materials, materials (including finishes or decorative surfaces applied to the materials) must meet the applicable test criteria prescribed in part I of appendix F of this part, or other approved equivalent methods, regardless of the passenger capacity of the aeroplane. ”

“ JAR 25.855 Cargo or baggage compartments.

- (d) Except for thermal/acoustic insulation materials, all other materials used in the construction of the cargo or baggage compartment must meet the applicable test criteria prescribed in part I of appendix F of this part or other approved equivalent methods. ”

“ JAR 25.856 Insulation materials.

Thermal/acoustic insulation material must meet the flame propagation test requirements of the proposed part VI of appendix F in appendix of this CRI, or other approved equivalent test requirements.

– END –

SPECIAL CONDITION	D-15 SC & IM: Brakes and Braking System
APPLICABILITY:	A380
REQUIREMENTS:	JAR 25.731, 25.735, JAA INT/POL 25/6
ADVISORY MATERIAL:	ACJ 25.735 (a), (b), (c), (d), (e)

BACKGROUND

Adverse in-service experience has shown the need for a requirement that the brakes are able to absorb the maximum kinetic energy corresponding to the most critical condition (e.g. rejected take-off, flapless landing at maximum weight etc.) when worn to the maximum wear limit authorised. This is the intent of JAA INT/POL/25/6 (issue 2 dated 01/01/2000).

As JAR 25 has not yet been amended to take into account this requirement, it is proposed to apply a Special Condition to the A380, in accordance with JAR 21.16(a)(3).

Airbus elected to comply with NPA 25D-291, which introduces a more recent standard for wheels and brakes requirements.

SPECIAL CONDITION

1. Add the following two new sub-paragraphs (d) and (e) to JAR 25.731.

JAR 25.731 Wheels

- (d) *Overpressure burst prevention.* Means must be provided in each wheel to prevent wheel failure and tyre burst that may result from excessive pressurisation of the wheel and tyre assembly.
- (e) *Braked wheels.* Each braked wheel must meet the applicable requirements of JAR 25.735.

2. Amend JAR 25.735 to read as follows:

JAR 25.735 Brakes and Braking Systems (See AMJ 25.735 / IM D-15)

- (a) *Approval.* Each assembly, consisting of a wheel(s) and brake(s), must be approved.
- (b) *Brake System Capability.* The brake system, associated systems and components must be designed and constructed so that:
 - (1) If any electrical, pneumatic, hydraulic or mechanical connecting or transmitting element fails, or if any single source of hydraulic or other brake operating energy supply is lost, it is possible to bring the aeroplane to rest with a braked roll stopping distance of not more than two times that obtained in determining the landing distance as prescribed in paragraph JAR 25.125.
 - (2) Fluid lost from a brake hydraulic system, following a failure in, or in the vicinity of, the brakes, is insufficient to cause or support a hazardous fire on the ground or in flight.
- (c) *Brake controls.* The brake controls must be designed and constructed so that:-
 - (1) Excessive control force is not required for their operation.
 - (2) If an automatic braking system is installed, means are provided to:
 - (i) arm and disarm the system, and
 - (ii) allow the pilot(s) to override the system by use of manual braking.
- (d) *Parking Brake.* The aeroplane must have a parking brake control that, when selected on, further attention, prevent the aeroplane from rolling on a dry and level paved runway when

the most adverse combination of maximum thrust on one engine and up to maximum ground idle thrust on any, or all, other engine(s) is applied. The control must be suitably located or be adequately protected to prevent inadvertent operation. There must be indication in the cockpit when the parking brake is not fully released.

(e) *Antiskid System*. If an anti-skid system is installed:

- (1) It must operate satisfactorily over the range of expected runway conditions without external adjustment.
- (2) It must, at all times, have priority over the automatic braking system (if installed).

(f) *Kinetic energy capacity*

- (1) Design landing stop. The design landing stop is an operational landing stop at maximum landing weight. The design landing stop brake kinetic energy absorption requirement of each wheel, brake, and tyre assembly must be determined. It must be substantiated by dynamometer testing that the wheel, brake and tyre assembly is capable of absorbing not less than this level of kinetic energy throughout the defined wear range of the brake. The energy absorption rate derived from the aeroplane manufacturer's braking requirements must be achieved. The mean deceleration must not be less than 10 fps².
- (2) Maximum kinetic energy accelerate-stop. The maximum kinetic energy accelerate-stop is a rejected take-off for the most critical combination of aeroplane take-off weight and speed. The accelerate-stop brake kinetic energy absorption requirement of each wheel, brake, and tyre assembly must be determined. It must be substantiated by dynamometer testing that the wheel, brake, and tyre assembly is capable of absorbing not less than this level of kinetic energy throughout the defined wear range of the brake. The energy absorption rate defined by the aeroplane manufacturer must be achieved. The mean deceleration must not be less than 6 fps².
- (3) Most severe landing stop. The most severe landing stop is a stop at the most critical combination of aeroplane landing weight and speed. The most severe landing stop brake kinetic energy absorption requirement of each wheel, brake, and tyre assembly must be determined. It must be substantiated by dynamometer testing that, at the declared fully worn limit(s) of the brake heat sink, the wheel, brake, and tyre assembly is capable of absorbing not less than this level of kinetic energy. The most severe landing stop need not be considered for extremely improbable failure conditions or if the maximum kinetic energy accelerate-stop energy is more severe."

(g) *Brake Condition after High Kinetic Energy Dynamometer Stop(s)*. Following the high kinetic energy stop demonstration(s) required by sub-paragraph (f) of this paragraph, with the parking brake promptly and fully applied for at least three (3) minutes, it must be demonstrated that for at least five (5) minutes from application of the parking brake, no condition occurs (or has occurred during the stop), including fire associated with the tyre or wheel and brake assembly, that could prejudice the safe and complete evacuation of the aeroplane.

(h) *Stored energy systems*. An indication to the flight crew of usable stored energy must be provided if a stored energy system is used to show compliance with sub-paragraph (b)(1) of this paragraph. The available stored energy must be sufficient for:

- (1) At least six (6) full applications of the brakes when an anti-skid system is not operating, And
- (2) Bringing the aeroplane to a complete stop when an anti-skid system is operating, under all runway surface conditions for which the aeroplane is certificated.

- (i) *Brake wear indicators*. Means must be provided for each brake assembly to indicate when the heat sink is worn to the permissible limit. The means must be reliable and readily visible.
- (j) *Over temperature burst prevention*. Means must be provided in each braked wheel to prevent wheel failure and tyre burst that may result from elevated brake temperatures. Additionally, all wheels must meet the requirements of JAR 25.731(d).
- (k) *Compatibility*. Compatibility of the wheel and brake assemblies with the aeroplane and its systems must be substantiated.

INTERPRETATIVE MATERIAL

IM D-15 PART I: AMJ 25.735

Delete ACJ 25.735 (a), ACJ 25.735 (b), ACJ 25.735 (c), ACJ 25.735 (d) and ACJ 25.735 (e).

Introduce a new Advisory Material (AMJ 25.735) as follows:

(a) Ref. JAR 25.735(a) Approval

Each wheel and brake assembly, fitted with each designated and approved tyre type and size where appropriate, should be shown to be capable of meeting the minimum standards and capabilities detailed in the applicable Joint Technical Standard Order (JT)SO, in conjunction with the type certification procedure for the aeroplane, or by any other means approved by the Authority. This applies equally to replacement, modified, or refurbished wheel and brake assemblies or components whether the changes are made by the Original Equipment Manufacturer (OEM) or others.

Additionally, the components of the wheels, brakes and braking systems should be designed to:

- (i) Withstand all pressures and loads, applied separately and in conjunction, to which they may be subjected in all operating conditions for which the aeroplane is certificated.
- (ii) Withstand simultaneous application of normal and emergency braking functions unless adequate design measures have been taken to prevent such a contingency.
- (iii) Meet the energy absorption requirements without auxiliary cooling devices (such as cooling fans etc.).
- (iv) Not induce unacceptable vibrations at any likely ground speed and condition or any operating condition (such as retraction or extension).
- (v) Protect against the ingress or effects of such foreign bodies or materials (water, mud, oil and other products) which may adversely affect their satisfactory performance.

Combinations of any additional wheel and brake assemblies should meet applicable airworthiness requirements as specified in sub-paragraphs (a) and (b) of JAR 21.101 to eliminate situations that may have adverse consequences on aeroplane braking control and performance. This includes the possibility of the use of modified brakes either alone i.e., as a "ship set" or alongside original equipment manufacturer's brakes and the mixing of separately approved assemblies.

Refurbished and Overhauled Equipment. Refurbished and Overhauled Equipment is equipment overhauled and maintained in accordance with the OEM's Component Maintenance Manual (CMM) and associated documents. Refurbishment and overhaul of an

approved brake not made in accordance with the applicable OEM Overhaul Instructions is considered under Replacement and Modified Equipment. It is necessary to demonstrate compliance of all refurbished configurations with applicable (J)TSO and aeroplane manufacturer's specifications. It is also necessary to verify that performance is compatible for any combination of mixed brake configurations including refurbished/overhauled and new brakes. It is essential to assure that Aeroplane Flight Manual (AFM) braking performance and landing gear and aeroplane structural integrity are not adversely altered.

Replacement and Modified Equipment. Replacement and Modified Equipment include changes to any approved wheel and brake assembly. Consultation with the aeroplane manufacturer on the extent of testing is recommended. Particular attention should be paid to potential differences in the primary brake system parameters, e.g. brake torque, energy capacity, vibration, brake sensitivity, dynamic response, structural strength, wear state, etc.. If comparisons are made to previously approved equipment, the test articles (other than the proposed parts to be changed) and conditions should be comparable, as well as the test procedures and equipment on which comparative tests are to be conducted. For wheel and brake assembly tests; tyre size, manufacturer, and ply rating used for the test(s) should be the same, and the tyre conditions should be comparable. For changes of any heat sink component parts, structural parts (including the wheel), friction couples, etc., it is necessary for the applicant to provide evidence of acceptable performance and compatibility with the aeroplane and its systems.

Changes to a brake might be considered as a minor change, as long as the changes are not to the friction elements, and the proposed change(s) cannot affect the aeroplane stopping performances, brake energy absorption characteristics, and/or continued airworthiness of the aeroplane or wheel and brake assembly (e.g. vibration and/or thermal control, brake retraction integrity, etc.). It is incumbent on the applicant to provide technical evidence justifying whether a change is minor. Changes to a wheel assembly outside the limits allowed in the OEM's CMM should be considered a major change due to potential airworthiness issues.

Past history with friction elements has indicated the necessity of on-going monitoring (by dynamometer test) of frictional and energy absorption capability to assure that they are maintained over the life of the aeroplane programme. These monitoring plans have complemented the detection and correction of unacceptable deviations. The applicant should demonstrate that frictional energy absorption capabilities of the friction elements are maintained over time.

Intermixing of wheel and brake assemblies from different suppliers on the same aeroplane is generally not acceptable due to the complexities experienced with differing friction elements, specific brake control system tuning, and other factors.

(b) Ref. JAR 25.735(b) Brake System Capability

The system should be designed so that any single failure of the system does not affect aeroplane stopping performance beyond doubling the braked roll stopping distance. Failures are considered to be fracture, leakage, or jamming of a component in the system or loss of an energy source. Components of the system include all parts that contribute to transmitting the pilot's braking command to the actual generation of braking force. Multiple failures resulting from a single cause shall be considered a single failure, for example, fracture of two or more hydraulic lines as a result of a single failure. Subcomponents within the brake assembly, such as brake discs, and actuators (or their equivalents), should be considered as connecting or transmitting elements, unless it is shown that leakage of hydraulic fluid resulting from failure of the sealing elements in these sub-components within

the brake assembly would not reduce the braking effectiveness below that specified in JAR 25.735(b)(1).

In order to meet the stopping distance requirements of JAR 25.735(b)(1) in the event of a failure in the normal system, it is common practice to provide an alternate brake system. The normal and alternate (secondary/emergency) braking systems should be independent, being supplied by separate power sources. Following a failure in the normal system, the changeover to a second system (whether manually or by automatic means) and the functioning of a secondary power source, should be effected rapidly and safely and should not involve the risk of wheel locking whether the brakes are applied or not at the time of the changeover.

The brake system and components should be separated or appropriately shielded so that complete failure of the braking system(s) as a result of a single cause is minimised.

Compliance with JAR 25.735(b)(2) may be achieved by (i) showing that fluid released would not impinge on the brake, or any part of the assembly that might cause the fluid to ignite, (ii) showing that the fluid will not ignite, or (iii) showing that the maximum amount of fluid which is released is not sufficient to sustain a fire.

Additionally, in the case of a fire the applicant may show that the fire is not hazardous taking into consideration such factors as landing gear geometry, location of fire sensitive (susceptible) equipment and installations, system status, flight mode, etc.

(c) Ref. JAR 25.735(c) Brake Controls

The braking force should increase or decrease progressively as the force or movement applied to the brake control is increased or decreased and the braking force should respond to the control as quickly as is necessary for safe and satisfactory operation. A brake control intended only for parking need not operate progressively. There should be no requirement to select the parking brake off in order to achieve a higher braking force with manual braking.

When an automatic braking system is installed such that various levels of braking (e.g. low, medium, high etc.) may be preselected to occur automatically following a touchdown, the pilot(s) should be provided with a means to arm and/or disarm the system prior to the touchdown that is separate from other brake controls.

The automatic braking system design should be evaluated for integrity and non-hazard, including the probability and consequence of insidious failure of critical components, and non-interference with the manual braking system. Single failures in the automatic braking system should not compromise non-automatic braking of the aeroplane. Automatic braking systems that are to be approved for use in the event of a rejected take-off should have a single selector position, set prior to take-off enabling this operating mode.

(d) Ref. JAR 25.735(d) Parking Brake

It should be demonstrated that the parking brake has sufficient capability in all allowable operating conditions (including Master Minimum Equipment List (MMEL) conditions) to be able to prevent the rotation of braked wheels (as opposed to skidding), with the stated engine power settings, and with the aeroplane configuration, (i.e. ground weight, C of G position, and nose-wheel (or tail-wheel) angle), least likely to result in skidding on a dry and level runway surface. Where reliable test data are available, substantiation by means other than aeroplane testing may be acceptable.

For compliance with the requirement for indication that the parking brake is not fully released, the indication means should be as closely associated with brake actuation as is practicable, rather than the selector (control). This requirement is separate from and in addition to the parking brake requirements associated with JAR 25.703(a)(3) Take-off warning systems.

The parking brake control, whether or not it is independent of the emergency brake control, should be marked with the words "Parking Brake" and should be constructed in such a way that, once operated, it can remain in the selected position without further flight crew attention. It should be located where inadvertent operation is unlikely or be protected, by suitable means, against inadvertent operation.

(e) Ref. JAR 25.735 (e) Anti-skid System

No single failure in the anti-skid system should result in the brakes being applied unless braking is being commanded by the pilot. In the event of any failure, an automatic or pilot controlled means (or both) should be available to allow continued braking without anti-skid.

Failures which render the system ineffective should not prevent manual braking control by the pilot(s) and should normally be indicated. Failure of brakes, wheels or tyres should not inhibit the function of the antiskid system for unaffected wheel brake and tyre assemblies.

The anti-skid system should be capable of giving satisfactory braking performance over the full range of tyre to runway friction coefficients and surface conditions without the need for pre-flight or pre-landing adjustments or selections. The range of friction coefficients should encompass those appropriate to dry, wet and contaminated surfaces and for both grooved and ungrooved runways.

The use of the phrase "...without external adjustment" of (e)(1) is intended to imply that once the antiskid system has been optimised for operation over the full range of expected conditions for which the aeroplane is to be type certificated, pre-flight or pre-landing adjustments made to the equipment to enable the expected capabilities to be achieved, are not acceptable. For example, a specific pre-landing selection for a landing on a contaminated, low μ runway following a take-off from a dry, high μ surface should not be necessary for satisfactory braking performance to be achieved.

It should be shown that the brake cycling frequency imposed by the antiskid installation will not result in excessive loads on the landing gear. Antiskid installations should not cause surge pressures in the brake hydraulic system which would be detrimental to either the normal or emergency brake system and components.

The system should be compatible with all tyre size and type combinations permitted and for all allowable wear states of the brakes and tyres. Where brakes of different types or manufacture are permitted, compatibility should be demonstrated or appropriate means should be employed to ensure that undesirable combinations are precluded.

(f) Ref. JAR 25.735(f) Kinetic Energy Capacity

The kinetic energy capacity of each tyre, wheel, and brake assembly should be at least equal to that part of the total aeroplane energy that the assembly will absorb during a stop, with the heat sink at a defined condition at the commencement of the stop.

(1) Calculation of Stop Kinetic Energy

The design landing stop, the maximum kinetic energy accelerate-stop, and the most severe landing stop brake kinetic energy absorption requirements of each wheel and brake assembly should be determined using either of the following methods:

- (i) A conservative rational analysis of the sequence of events expected during the braking manoeuvre, or
- (ii) A direct calculation based on the aeroplane kinetic energy at the commencement of the braking manoeuvre.

When determining the tyre, wheel and brake assembly kinetic energy absorption requirement using the rational analysis method, the analysis should use conservative values of the aeroplane speeds at which the brakes are first applied, the range of the expected coefficient of friction between the tyres and runway, aerodynamic and propeller drag, powerplant forward thrust, and, if more critical, the most adverse single engine or propeller malfunction.

When determining the tyre, wheel and brake assembly energy absorption requirements using the direct calculation method, the following formula, which needs to be modified in cases of designed unequal braking distribution, should be used:

$$KE = 0.0443 WV^2/N \text{ (ft lb)}$$

Where,

- KE = Kinetic energy per wheel (ft lb)
- N = Number of wheels with brakes
- W = Aeroplane weight (lb)
- V = Aeroplane speed (Knots)

OR

$$KE = 0.5m V^2/N \text{ (Joule)}$$

Where,

- KE = Kinetic energy per wheel (J)
- N = Number of wheels with brakes
- m = Aeroplane mass (Kg)
- V = Aeroplane speed (m/s)

For all cases, V is the ground speed and takes into account the prevailing operational conditions. All approved landing flap conditions should be considered when determining the design landing stop energy.

These calculations should take into account cases of designed unequal braking distributions. "Designed unequal braking distributions" refers to unequal braking loads between wheels that result directly from the design of the aeroplane: for example due to the use of both main-wheel and nose-wheel brakes, or the use of brakes on a centre-line landing gear supporting lower vertical loads per braked wheel than the main landing gear braked wheels. It is intended that this term should take account of effects such as runway crown. Crosswind effects need not be considered.

For the design landing case, the aeroplane speed must not be less than $V_{REF}/1.3$ where V_{REF} is the aeroplane steady landing approach speed at the maximum design landing weight and in the landing configuration at sea level. Alternatively, the aeroplane speed must not be less than V_{SO} , the power-off stall speed of the aeroplane at sea level, at the design landing weight, and in the landing configuration.

(2) Heat sink condition at the commencement of the stop

For the maximum kinetic energy accelerate-stop case the calculation should take account of the brake temperature following a previous typical landing, the effects of braking during taxi-in, the temperature change whilst parked, the effects of braking during taxi-out, and the temperature change during the take-off acceleration phase up to the time of brake application. The analysis may not take account of auxiliary cooling devices. Conservative assessments of typical ambient conditions and the time the aeroplane will be on the ground, should be used.

For the most severe landing stop case, the same temperature conditions and changes used for the maximum kinetic energy accelerate-stop case should be assumed, except that further temperature change during the additional flight phase may be considered. The duration of this additional flight phase should be determined as the minimum practicable between the take-off and landing on the same runway with the aeroplane in a configuration which would enable such a return to be made. However, should it be determined that the most severe landing stop can only reasonably occur after a more extended flight phase, this may also influence the determined heat sink temperature.

The brake temperature at the commencement of the braking manoeuvre should be determined using the rational analysis method except that, in the absence of such analysis, an arbitrary heatsink temperature equal to the normal ambient temperature increased by the amount that would result from a 10% maximum kinetic energy accelerate-stop for the accelerate-stop case and from a 5% maximum kinetic energy accelerate-stop for landing cases should be used.

(3) Substantiation

Substantiation that the wheel and brake assemblies are capable of absorbing the determined levels of kinetic energy at all permitted wear states, up to and including the declared fully worn limits, is required. The term wear "state" is used in order to clarify that consideration should be given to possible inconsistencies or irregularities in brake wear in some circumstances, such as greater wear at one end of the heat sink than the other. Qualification related to evenly distributed heat sink wear may not be considered adequate. If the typical in-service wear distribution is significantly different from the wear distribution used during qualification testing, additional substantiation and/or corrective action may be necessary.

The minimum initial brakes-on speed used in the dynamometer test should not be more than the velocity (V) used in the determination of JAR 25.735(f) kinetic energy requirements. This assumes that the test procedure involves a specified rate of deceleration and therefore, for the same amount of kinetic energy, a higher initial brakes-on speed would result in a lower rate of energy absorption. However, a brake test having a higher initial brakes-on speed is acceptable if the dynamometer test showed that both the energy absorbed and energy absorption rate required by JAR 25.735(f) had been achieved. Such a situation is recognised and is similarly stated in the (J)TSO-C135, which provides an acceptable means for brake approval under JAR 25.735(a).

Brake qualification tests are not intended as a means of determining expected aeroplane stopping performance, but may be used as an indicator for the most critical brake wear state for aeroplane braking performance measurements.

(g) Ref. JAR 25.735(g) Brake Condition after High Kinetic Energy Dynamometer Stop(s)

Following the high kinetic energy stop(s), the parking brake should be capable of restraining further movement of the aeroplane and should maintain this capability for the period during which the need for an evacuation of the aeroplane can be determined and then fully accomplished.

It should be demonstrated that, with a parking brake application within a period not exceeding 20 seconds of achieving a full stop, or within 20 seconds from the time that the speed is retarded to 20 knots (or lower) in the event that the brakes are released prior to achieving a full stop (as permitted by (J)TSO-C135), the parking brake can be applied normally and that it remains functional over the three (3) minutes required.

Practical difficulties associated with dynamometer design may preclude directly demonstrating the effectiveness of the parking brake in the period immediately following the maximum energy dynamometer stop(s). Where such difficulties prevail it should be shown that, for the three (3) minute period no structural failure or other condition of the brake components occurs that would significantly impair the parking brake function.

Regarding the initiation of a fire, it should be demonstrated that no continuous or sustained fire extending above the highest point of the tyre occurs before the five (5) minute period has elapsed. Either should any other condition arise during this same period or during the stop, either separately or in conjunction with a fire, which could be reasonably judged to prejudice the safe and complete aeroplane evacuation. Fire of limited extent and of a temporary nature (e.g. involving wheel bearing lubricant or minor oil spillage) is acceptable. For this demonstration, neither firefighting means nor coolants may be applied.

(h) Ref. JAR 25.735(h) Stored energy systems

Stored energy systems use a self-contained source of power such as a gas pressurised hydraulic accumulator or a charged battery.

This requirement is not applicable to those aeroplanes that provide a number of independent braking systems, even though they may incorporate a stored energy source(s), but which are not "reliant" on the stored energy system for the demonstration of compliance with sub-paragraph (b) of this paragraph.

The indication of usable stored energy should show:

- (1) The minimum energy level necessary to meet the requirements of JAR 25.735 (b)(1) and (h), i.e. the acceptable level for dispatch of the aeroplane,
- (2) The remaining energy level, and,
- (3) The energy level below which further brake application may not be possible.

If a gas pressurised hydraulic accumulator is to be used as the energy storage means, indication of accumulator pressure alone is not considered adequate means to indicate available stored energy.

An accumulator pressure gauge may be acceptable if correct precharge pressure with the hydraulic system pressure off and the correct fluid volume with the hydraulic system pressure on, can be verified. Furthermore, additional safeguards may be necessary to ensure that sufficient stored energy will be available at the end of the flight.

Similar considerations should be made when other energy storage means are used.

A full brake application is defined as application from brakes fully released to brakes fully applied and back to fully released.

(i) Ref. JAR 25.735(i) Brake wear indicators

The indication means should be located such that no special tool or illumination (except in darkness) is required. Expert interpretation of the indication should not be necessary.

(j) Ref. JAR 25.731(d) and JAR 25.735(j) Overtemperature and Overpressure Burst Prevention

Generally, two separate types of protection should be provided; one specifically to release the tyre pressure should the wheel temperature increase to an unacceptable level, and the other to release the tyre pressure should the pressure become unacceptably high, particularly during the inflation process. The temperature sensitive devices are required in braked wheels only, but the pressure sensitive devices are required in all wheels.

The temperature sensitive device(s), (e.g. a fuse or fusible plug), should be sufficient in number and appropriately located to reduce the tyre pressure to a safe level, before any part of the wheel becomes unacceptably hot, irrespective of the wheel orientation. The device(s) should be designed and installed such that once operated (or triggered), their continued operation is not impaired by the releasing gas.

The effectiveness of these devices in preventing hazardous tyre blow-out or wheel failure should be demonstrated. It should also be demonstrated that the devices will not release the tyre pressure prematurely during take-off or landing, including during "quick turn-around" types of operation.

It should be shown that the over-pressurisation protection device(s), or the device(s) in combination with the inflation means permanently installed in the wheel, would not permit the tyre pressure to reach an unsafe level, regardless of the capability of the inflation source.

Both types of device should normally be located within the structure of the wheel in positions which minimise the risk of damage or tampering during normal maintenance.

(k) Ref. JAR 25.735(k) Compatibility

During brake qualification testing, sufficient dynamometer testing over the range of permissible brake wear states, energy levels, brake pressures, brake temperatures and speeds should be undertaken to provide information necessary for systems integration. As part of the overall substantiation of safe and anomaly free operation, it is necessary to show that no unsafe conditions arise from incompatibilities between the brakes and brake system with other aeroplane systems and structures. Areas such as antiskid tuning, landing gear dynamics, tyre type and size, brake combinations, brake characteristics, brake and landing gear vibrations, etc. need to be explored. Similarly, wheel and tyre compatibility should be addressed.

These issues should be re-addressed when the equipment is modified.

IM D-15 PART II - Transport Aeroplane Wheels and Wheel and Brake Assemblies qualification standards (from TSO C135)**1. APPLICABILITY.**

The following prescribes minimum performance standard applicable for transport category aeroplane wheels, and wheel and brake assemblies. The minimum performance standard defined in the following appendix are equivalent to FAA TSO C-135, published by FAA on May 2nd, 2002. Conformity wheels, and wheels and brakes assemblies, to the following performance standard may be documented using the DDP format and procedure (ref. Joint Certification/validation procedures, appendix 6), or by conformity to the FAA TSO C- 135, or by conformity to the relevant JTSC135, when this JTSC135 will be available.

2. MARKING.

- a. The following information shall be legibly and permanently marked on the major equipment components:
- (1) Name of the manufacturer responsible for compliance
 - (2) Serial Number
 - (3) Part Number
 - (4) Applicable technical standard order (JTSO/TSO) number, if any.
 - (5) Rim size (This marking applies to wheels only)
 - (6) Hydraulic Fluid Specification (This marking applies to brakes only)
- b. All stamped, etched, or embossed markings must be located in non-critical areas.

3. DATA REQUIREMENTS.

The following shall be furnished by the equipment manufacturer:

- 3.1. The applicable limitations pertaining to installation of wheels or wheel and brake assemblies on aeroplane(s), including the data requirements of paragraph 4.1 of Appendix 1.
- 3.2. The manufacturer's qualification test report.
- 3.3. all applicable maintenance instructions and data necessary for continued airworthiness.

APPENDIX 1: MINIMUM PERFORMANCE SPECIFICATION FOR TRANSPORT AIRPLANE WHEELS, BRAKES, AND WHEEL AND BRAKE ASSEMBLIES

CHAPTER 1 INTRODUCTION

1.1. PURPOSE AND SCOPE

This Minimum Performance Specification defines the minimum performance standards for wheels, brakes, and wheel and brake assemblies to be used on aeroplanes certified to JAR 25. Compliance with this specification is not considered approval for installation on any transport aeroplane.

1.2. APPLICATION

Compliance with this minimum specification by manufacturers, installers and users is required as a means of assuring that the equipment will have the capability to satisfactorily perform its intended function(s).

Note: Certain performance capabilities may be affected by aeroplane operational characteristics and other external influences. Consequently, anticipated aeroplane braking performance should be verified by aeroplane testing.

1.3. COMPOSITION OF EQUIPMENT

The words “equipment” or “brake assembly” or “wheel assembly,” as used in this document, include all components that form part of the particular unit.

For example, a wheel assembly typically includes a hub or hubs, bearings, flanges, drive bars, heat shields, and fuse plugs. A brake assembly typically includes a backing plate, torque tube, cylinder assemblies, pressure plate, heat sink, and temperature sensor.

It should not be inferred from these examples that each wheel assembly and brake assembly will necessarily include either all or any of the above example components; the actual assembly will depend on the specific design chosen by the manufacturer.

1.4. DEFINITIONS AND ABBREVIATIONS

1.4.1 Brake Lining.

Brake lining is individual blocks of wearable material, discs that have wearable material integrally bonded to them, or discs in which the wearable material is an integral part of the disc structure.

1.4.2 $BROP_{MAX}$ - Brake Rated Maximum Operating Pressure

- $BROP_{MAX}$ = Brake Rated Maximum Operating Pressure.

$BROP_{MAX}$ is the maximum design metered pressure which is available to the brake to meet aeroplane stopping performance requirements.

1.4.3 BRP_{MAX} - Brake Rated Maximum Pressure

- BRP_{MAX} = Brake Rated Maximum Pressure

BRP_{MAX} is the maximum pressure to which the brake is designed to be subjected (typically aeroplane nominal maximum system pressure).

1.4.4 BRP_{RET} - Brake Rated Retraction Pressure

- BRP_{RET} = Brake Rated Retraction Pressure.

BRP_{RET} is the highest pressure at which full retraction of the piston is assured.

1.4.5 $BRPP_{MAX}$ - Brake Rated Maximum Parking Pressure

- $BRPP_{MAX}$ = Brake Rated Maximum Parking Pressure.

$BRPP_{MAX}$ is the maximum parking pressure available to the brake.

1.4.6 BRWL - Brake Rated Wear Limit

- BRWL = Brake maximum wear limit to ensure compliance with paragraph 3.3.3, and, if applicable, paragraph 3.3.4.

1.4.7 D - Distance Averaged Deceleration

- $D = ((\text{Initial brakes-on speed})^2 - (\text{Final brakes-on speed})^2) / (2 (\text{braked flywheel distance}))$

D is the distance averaged deceleration to be used in all deceleration calculations.

1.4.8 D_{DL} - Rated Design Landing Deceleration

- D_{DL} = Rated Design Landing Deceleration.

D_{DL} is the minimum of the distance averaged decelerations demonstrated by the wheel, brake and tire assembly during the 100 KE_{DL} stops of paragraph 3.3.2.

1.4.9 D_{RT} - Rated Accelerate-Stop Deceleration

- D_{RT} = Rated Accelerate-Stop Deceleration.

D_{RT} is the minimum of the distance averaged decelerations demonstrated by the wheel, brake, and tire assembly during the KERT stops of paragraph 3.3.3.

1.4.10 D_{SS} - Rated Most Severe Landing Stop Deceleration.

- D_{SS} = Rated Most Severe Landing Stop Deceleration.

D_{SS} is the distance averaged deceleration demonstrated by the wheel, brake and tire assembly during the KE_{SS} Stop of paragraph 3.3.4.

1.4.11 Heat Sink

The heat sink is the mass of the brake that is primarily responsible for absorbing energy during a stop. For a typical brake, this would consist of the stationary and rotating disc assemblies.

1.4.12 KE_{DL} - Wheel/Brake Rated Design Landing Stop Energy

- KE_{DL} = Wheel/Brake Rated Design Landing Stop Energy.

KE_{DL} is the minimum energy absorbed by the wheel/brake/tire assembly during any stop of the 100 stop Design Landing Stop Test. (paragraph 3.3.2).

1.4.13 KE_{RT} - Wheel/Brake Rated Accelerate-Stop Energy

- KE_{RT} = Wheel/Brake Rated Accelerate-Stop Energy.

KE_{RT} is the energy absorbed by the wheel/brake/tire assembly demonstrated in accordance with the Accelerate-Stop test in paragraph 3.3.3.

1.4.14 KE_{SS} - Wheel/Brake Rated Most Severe Landing Stop Energy

- KE_{SS} = Wheel/Brake Rated Most Severe Landing Stop Energy.

KE_{SS} is the energy absorbed by the wheel/brake/tire assembly demonstrated in accordance with paragraph 3.3.4.

1.4.15 L - Wheel Rated Radial Limit Load

- L = Radial Limit Load.

L is the Wheel Rated Maximum Radial Limit Load (paragraph 3.2.1).

1.4.16 R - Wheel Rated Tire Loaded Radius

- R = Static Radius at load “S” for the Wheel Rated Tire Size at WRP. The static radius is defined as the minimum distance from the axle centreline to the tire/ground contact interface.

1.4.17 S - Wheel Rated Static Load

- S is the Maximum Static Load (Reference § 25.731(b)).

1.4.18 ST_R - Wheel/Brake Rated Structural Torque

- ST_R = Wheel/Brake Rated Structural Torque.

ST_R is the maximum structural torque demonstrated (paragraph 3.3.5).

1.4.19 TS_{BR} - Brake Rated Tire Type(s) and Size(s) .

- TS_{BR} = Brake Rated Tire Type(s) and Size(s).

TS_{BR} is the tire type(s) and size(s) used to achieve the KE_{DL} , KE_{RT} , and KE_{SS} brake ratings. TS_{BR} must be a tire type and size approved for installation on the wheel (TS_{WR}).

1.4.20 TS_{WR} - Wheel Rated Tire Type(s) and Size(s)

- TS_{WR} = Wheel Rated Tire Type(s) and Size(s) defined for use and approved by the aeroplane manufacturer for installation on the wheel.

1.4.21 TT_{BT} - Suitable Tire for Brake Tests .

- TT_{BT} = Rated Tire Type and Size.

TT_{BT} is the tire type and size that has been determined as being the most critical for brake performance and/or energy absorption tests. TT_{BT} must be a tire type and size approved for installation on the wheel (TS_{WR}). The suitable tire may be different for different tests.

1.4.22 TT_{WT} - Suitable Tire for Wheel Test

- TT_{WT} = Wheel Rated Tire Type and Size for Wheel Test.

TT_{WT} is the tire type and size determined as being the most appropriate to introduce loads and/or pressure that would induce the most severe stresses in the wheel. TT_{WT} must be a tire type and size approved for installation on the wheel (TS_{WR}). The suitable tire may be different for different tests.

1.4.23 V_{DL} - Wheel/Brake Design Landing Stop Speed

- V_{DL} = Wheel/Brake Design Landing Stop Speed.

V_{DL} is the initial brakes-on speed for a Design Landing Stop (paragraph 3.3.2).

1.4.24 V_R - Aeroplane Maximum Rotation Speed

- V_R = Aeroplane Maximum Rotation Speed.

1.4.25 V_{RT} - Wheel/Brake Accelerate-Stop Speed

- V_{RT} = Wheel/Brake Accelerate-Stop Speed.

V_{RT} is the initial brakes-on speed used to demonstrate KE_{RT} (paragraph 3.3.3).

1.4.26 V_{SS} - Wheel/Brake Most Severe Landing Stop Speed.

- V_{SS} = Wheel/Brake Most Severe Landing Stop Speed.

V_{SS} is the initial brakes-on speed used to demonstrate KE_{SS} (paragraph 3.3.4).

1.4.27 WRP - Wheel Rated Inflation Pressure

WRP is the Wheel Rated Inflation Pressure (wheel unloaded).

CHAPTER 2 GENERAL DESIGN SPECIFICATION

2.1. AIRWORTHINESS.

The continued airworthiness of the aeroplane on which the equipment is to be installed must be considered.

2.2. FIRE PROTECTION.

Except for small parts (such as fasteners, seals, grommets and small electrical parts) that would not contribute significantly to the propagation of a fire, all solid materials used must be self-extinguishing. See also paragraphs 2.4.5, 3.3.3.5 and 3.3.4.5.

2.3. DESIGN.

Unless shown to be unnecessary by test or analysis, the equipment must comply with the following:

2.3.1 Wheel Bearing Lubricant Retainers.

Wheel bearing lubricant retainers must retain the lubricant under all operating conditions, prevent the lubricant from reaching braking surfaces, and prevent foreign matter from entering the bearings.

2.3.2 Removable Flanges.

All removable flanges must be assembled onto the wheel in a manner that will prevent the removable flanges and retaining devices from leaving the wheel if a tire deflates while the wheel is rolling.

2.3.3 Adjustment.

The brake mechanism must be equipped with suitable adjustment devices to maintain appropriate running clearance when subjected to BRP_{RET}.

2.3.4 Water Seal.

Wheels intended for use on amphibious aircraft must be sealed to prevent entrance of water into the wheel bearings or other portions of the wheel or brake, unless the design is such that brake action and service life will not be impaired by the presence of sea water or fresh water.

2.3.5 Burst Prevention.

Means must be provided to prevent wheel failure and tire burst that might result from over pressurization or from elevated brake temperatures. The means must take into account the pressure and the temperature gradients over the full operating range.

2.3.6 Wheel Rim and Inflation Valve.

Tire and Rim Association (Reference: Aircraft Year Book-Tire and Rim Association Inc.) or, alternatively, The European Tyre and Rim Technical Organisation (Reference: Aircraft Tyre and Rim Data Book) approval of the rim dimensions and inflation valve is encouraged.

2.3.7 Brake Piston Retention.

The brake must incorporate means to ensure that the actuation system does not allow hydraulic fluid to escape if the limits of piston travel are reached.

2.3.8 Wear Indicator.

A reliable method must be provided for determining when the heat sink is worn to its permissible limit.

2.3.9 Wheel Bearings.

Means should be incorporated to avoid misassembly of wheel bearings.

2.3.10 Fatigue.

The design of the wheel must incorporate techniques to improve fatigue resistance of critical areas of the wheel and minimise the effects of the expected corrosion and temperature environment. The wheel must include design provisions to minimise the probability of fatigue failures that could lead to flange separation or other wheel burst failures.

2.3.11 Dissimilar Materials.

When dissimilar materials are used in the construction and the galvanic potential between the materials indicate galvanic corrosion is likely, effective means to prevent the corrosion must be incorporated in the design. In addition, differential thermal expansion must not unduly affect the functioning, load capability, and the fatigue life of the components.

2.4 CONSTRUCTION.

The suitability and durability of the materials used for components must be established on the basis of experience or tests. In addition, the materials must conform to approved specifications that ensure the strength and other properties are those that were assumed in the design.

2.4.1 Castings.

Castings must be of high quality, clean, sound, and free from blowholes, porosity, or surface defects caused by inclusions, except that loose sand or entrapped gases may be allowed when serviceability is not impaired.

2.4.2 Forgings.

Forgings must be of uniform condition, free from blisters, fins, folds, seams, laps, cracks, segregation, and other defects. Imperfections may be removed if strength and serviceability would not be impaired as a result.

2.4.3 Bolts and Studs.

When bolts or studs are used for fastening together sections of a wheel or brake, the length of the threads must be sufficient to fully engage the nut, including its locking feature, and there must be sufficient unthreaded bearing area to carry the required load.

2.4.4 Environmental Protection.

All the components used must be suitably protected against deterioration or loss of strength in service due to any environmental cause, such as weathering, corrosion, and abrasion.

2.4.5 Magnesium Parts.

Magnesium and alloys having magnesium as a major constituent must not be used on brakes or braked wheels.

CHAPTER 3

MINIMUM PERFORMANCE UNDER STANDARD TEST CONDITIONS

3.1 INTRODUCTION.

The test conditions and performance criteria described in this Chapter provide a laboratory means of demonstrating compliance with this TSO minimum performance standard. The aeroplane manufacturer must define all relevant test parameter values.

3.2 WHEEL TESTS.

To establish the ratings for a wheel, it must be substantiated that standard production wheel samples will meet the following radial load, combined load, roll load, roll-on-rim (if applicable) and overpressure test requirements.

For all tests, except the roll-on-rim test of paragraph 3.2.4, the wheel must be fitted with a suitable tire, TT_{WT} , and wheel loads must be applied through the tire. The ultimate load tests of paragraphs

3.2.1.3 and 3.2.2.3 provide for an alternative method of loading if it is not possible to conduct these tests with the tire mounted.

3.2.1 Radial Load Test.

If the radial limit load of paragraph 3.2.2 is equal to or greater than the radial limit load of this paragraph, the test specified in this paragraph may be omitted.

Test the wheel for yield and ultimate loads as follows:

3.2.1.1 Test method.

With a suitable tire, TT_{WT} , installed, mount the wheel on its axle, and position it against a flat, nondeflecting surface. The wheel axle must have the same angular orientation to the non-deflecting surface that it will have to a flat runway when it is mounted on an aeroplane and is under the maximum radial limit load, L .

Inflate the tire to the pressure recommended for the Wheel Rated Static Load, S , with gas and/or liquid. If liquid inflation is used, liquid must be bled off to obtain the same tire deflection that would result if gas inflation were used.

Liquid pressure must not exceed the pressure that would develop if gas inflation were used and the tire were deflected to its maximum extent. Load the wheel through its axle with the load applied perpendicular to the flat, non-deflecting surface. Deflection readings must be taken at suitable points to indicate deflection and permanent set of the wheel rim at the bead seat.

3.2.1.2 Yield Load.

Apply to the wheel and tire assembly a load not less than 1.15 times the maximum radial limit load, L , as determined under 14 CFR 25.471 through 25.511, as appropriate.

Determine the most critical wheel orientation with respect to the non-deflecting surface. Apply the load with the tire loaded against the non-deflecting surface, and with the wheel rotated 90 degrees with respect to the most critical orientation. Repeat the loading with the wheel 180, 270, and 0 degrees from the most critical orientation. The bearing cups, cones, and rollers used in operation must be used for these loadings. If, at a point of loading during the test, bottoming of the tire occurs, the tire pressure may be increased an amount sufficient only to prevent bottoming.

Three successive loadings at the 0 degree position must not cause permanent set increments of increasing magnitude. The permanent set increment caused by the last loading at the 0 degree position may not exceed 5 percent of the deflection caused by that loading or .005 inches (.125mm), whichever is greater. There must be no yielding of the wheel such as would result in loose bearing cups, liquid or gas leakage through the wheel or past the wheel seal. There must be no interference in any critical areas between the wheel and brake assembly, or between the most critical deflected tire and brake (with fittings) up to limit load conditions, taking into account the axle flexibility. Lack of interference can be established by analyses and/or tests.

3.2.1.3 Ultimate Load.

Apply to the wheel used in the yield test of paragraph 3.2.1.2, and the tire assembly, a load not less than 2 times the maximum radial limit load, L , for castings, and 1.5 times the maximum radial limit load, L , for forgings, as determined under JAR 25.471 through 25.511, as appropriate.

Apply the load with the tire and wheel against the non-deflecting surface and the wheel positioned at 0 degree orientation (paragraph 3.2.1.2). The bearing cones may be replaced with conical bushings, but the cups used in operation must be used for this loading. If, at a point of loading during the test, it is shown that the tire will not successfully maintain pressure or if bottoming of the tire occurs, the tire pressure may be increased. If bottoming of the tire continues to occur with increased pressure, a loading block that fits between the rim flanges and simulates the load transfer of the inflated tire may be used. The arc of the wheel supported by the loading block must be no greater than 60 degrees.

The wheel must support the load without failure for at least 3 seconds. Abrupt loss of load-carrying capability or fragmentation during the test constitutes failure.

3.2.2 Combined Radial and Side Load Test.

Test the wheel for the yield and ultimate loads as follows:

3.2.2.1 Test Method.

With a suitable tire, Π_{WT} , installed, mount the wheel on its axle and position it against a flat, nondeflecting surface. The wheel axle must have the same angular orientation to the non-deflecting surface that it will have to a flat runway when it is mounted on an aeroplane and is under the combined radial and side limit loads. Inflate the tire to the pressure recommended for the maximum static load with gas and/or liquid. If liquid inflation is used, liquid must be bled off to obtain the same tire deflection that would result if gas inflation were used.

Liquid pressure must not exceed the pressure that would develop if gas inflation were used and the tire were deflected to its maximum extent. For the radial load component, load the wheel through its axle with load applied perpendicular to the flat non-deflecting surface. Apply the two loads simultaneously, increasing them either continuously or in increments no greater than 10 percent of the total loads to be applied.

If it is impossible to generate the side load because of friction limitations, the radial load may be increased, or a portion of the side load may be applied directly to the tire/wheel. In such circumstances it must be demonstrated that the moment resulting from the side load is no less severe than would otherwise have occurred.

Alternatively, the vector resultant of the radial and side loads may be applied to the axle.

Deflection readings must be taken at suitable points to indicate deflection and permanent set of the wheel rim at the bead seat.

3.2.2.2 Combined Yield Load.

Apply to the wheel and tire assembly radial and side loads not less than 1.15 times the respective ground limit loads, as determined under JAR 25.485, 25.495, 25.497, and 25.499 as appropriate. If, at a point of loading during the test, bottoming of the tire occurs, the tire pressure may be increased an amount sufficient only to prevent bottoming.

Determine the most critical wheel orientation with respect to the non-deflected surface.

Apply the load with the tire loaded against the non-deflecting surface, and with the wheel rotated 90 degrees with respect to the most critical orientation. Repeat the loading with the wheel 180, 270, and 0 degrees from the most critical orientation.

The bearing cups, cones, and rollers used in operation must be used in this test.

A tube may be used in a tubeless tire only when it has been demonstrated that pressure will be lost due to the inability of a tire bead to remain properly positioned under the load. The wheel must be tested for the most critical inboard and outboard side loads.

Three successive loadings at the 0 degree position must not cause permanent set increments of increasing magnitude. The permanent set increment caused by the last loadings at the 0 degree position must not exceed 5 percent of the deflection caused by the loading, or .005 inches (.125mm), whichever is greater. There must be no yielding of the wheel such as would result in loose bearing cups, gas or liquid leakage through the wheel or past the wheel seal. There must be no interference in any critical areas between the wheel and brake assembly, or between the most critical deflected tire and brake (with fittings) up to limit load conditions, taking into account the axle flexibility. Lack of interference can be established by analyses and/or tests.

3.2.2.3 Combined Ultimate Load.

Apply to the wheel, used in the yield test of paragraph 3.2.2.2, radial and side loads not less than 2 times for castings and 1.5 times for forgings, the respective ground limit loads as determined under JAR 25.485, 25.495, 25.497, and 25.499, as appropriate.

Apply these loads with a tire and wheel against the non-deflecting surface and the wheel oriented at the 0 degree position (paragraph 3.2.2.2). The bearing cones may be replaced with conical bushings; however, the cups used in operation must be used for this loading.

If, at any point of loading during the test, it is shown that the tire will not successfully maintain pressure, or if bottoming of the tire on the non-deflecting surface occurs, the tire pressure may be increased. If bottoming of the tire continues to occur with this increased pressure, a loading block that fits between the rim flanges and simulates the load transfer of the inflated tire may be used. The arc of wheel supported by the loading block must be no greater than 60 degrees.

The wheel must support the loads without failure for at least 3 seconds. Abrupt loss of load-carrying capability or fragmentation during the test constitutes failure.

3.2.3 Wheel Roll Test.

3.2.3.1 Test Method.

With a suitable tire, TT_{WT} , installed, mount the wheel on its axle and position it against a flat nondeflecting surface or a flywheel. The wheel axle must have the same angular orientation to the non-deflecting surface that it will have to a flat runway when it is mounted on an aeroplane and is under the Wheel Rated Static Load, S . During the roll test, the tire pressure must not be less than 1.14 times the Wheel Rated Inflation Pressure, WRP , (0.10 to account for temperature rise and 0.04 to account for loaded tire pressure). For side load conditions, the wheel axle must be yawed to the angle that will produce a wheel side load component equal to $0.15 S$ while the wheel is being roll tested.

3.2.3.2 Roll Test.

The wheel must be tested under the loads and for the distances shown in Table 3-1.

TABLE 3-1 Load Conditions and Roll Distances for Roll Test

Load Conditions	Roll Distance Miles (km)
Wheel Rated Static Load, S	2000 (3220)
Wheel Rated Static Load, S , plus a $0.15xS$ side load applied in the outboard direction	100 (161)
Wheel Rated Static Load, S , plus a $0.15xS$ side load applied in the inboard direction	100 (161)

At the end of the test, the wheel must not be cracked, there must be no leakage through the wheel or past the wheel seal(s), and the bearing cups must not be loose.

3.2.4 Roll-on-Rim Test (not applicable to nose wheels).

The wheel assembly without a tire must be tested at a speed of no less than 10 mph (4.6 m/s) under a load equal to the Wheel Rated Static Load, S . The test roll distance (in feet) must be determined as $0.5V_R^2$ but need not exceed 15,000 feet (4572 meters). The test axle angular orientation with the load surface must represent that of the aeroplane axle to the runway under the static load S .

The wheel assembly must support the load for the distance defined above. During the test, no fragmentation of the wheel is permitted; cracks are allowed.

3.2.5 Overpressure Test.

The wheel assembly, with a suitable tire, TT_{WT} , installed, must be tested to demonstrate that it can withstand the application of 4.0 times the wheel rated inflation pressure, WRP. The wheel must retain the pressure for at least 3 seconds. Abrupt loss of pressure containment capability or fragmentation during the test constitutes failure. Plugs may be used in place of over pressurization protection device(s) to conduct this test.

3.2.6 Diffusion Test.

A tubeless tire and wheel assembly must hold its rated inflation pressure, WRP, for 24 hours with a pressure drop no greater than 5 percent. This test must be performed after the tire growth has stabilised.

3.3 WHEEL AND BRAKE ASSEMBLY TESTS.

3.3.1 General.

3.3.1.1 The wheel and brake assembly, with a suitable tire, TT_{BT} , installed, must be tested on a testing machine in accordance with the following, as well as paragraphs 3.3.2, 3.3.3, 3.3.5 and, if applicable, 3.3.4.

3.3.1.2 For tests detailed in paragraphs 3.3.2, 3.3.3 and 3.3.4, the test energies KE_{DL} , KE_{RT} , and KE_{SS} and brake application speeds V_{DL} , V_{RT} , and V_{SS} are as defined by the aeroplane manufacturer.

3.3.1.3 For tests detailed in paragraphs 3.3.2, 3.3.3 and 3.3.4, the initial brake application speed must be as close as practicable to, but not greater than, the speed established in accordance with paragraph 3.3.1.2, with the exception that marginal speed increases are allowed to compensate for brake pressure release permitted under paragraphs 3.3.3.4 and 3.3.4.4. An increase in the initial brake application speed is not a permissible method of accounting for a reduced (i.e. lower than ideal) dynamometer mass. This method is not permissible because, for a target test deceleration, a reduction in the energy absorption rate would result, and could produce performance different from that which would be achieved with the correct brake application speed. The energy to be absorbed during any stop must not be less than that established in accordance with paragraph 3.3.1.2. Additionally, forced air or other artificial cooling means are not permitted during these stops.

3.3.1.4 The brake assembly must be tested using the fluid (or other actuating means) specified for use with the brake on the aeroplane.

3.3.2 Design Landing Stop Test.

3.3.2.1 The wheel and brake assembly under test must complete 100 stops at the KE_{DL} energy, each at the mean distance averaged deceleration, D , defined by the aeroplane manufacturer, but not less than 10 ft/s² (3.05 m/s²).

3.3.2.2 During the design landing stop test, the disc support structure must not be changed if it is intended for reuse, or if the wearable material is integral to the structure of the disc. One change of individual blocks or integrally bonded wearable material is permitted. For discs using integrally bonded wearable material, one change is permitted, provided that the disc support structure is not intended for reuse. The remainder of the wheel/brake assembly parts must withstand the 100 KE_{DL} stops without failure or impairment of operation.

3.3.3 Accelerate -Stop Test.

3.3.3.1 The wheel and brake assembly under test must complete the Accelerate-Stop test at the mean distance averaged deceleration, D , defined by the aeroplane manufacturer, but not less than 6 ft/s² (1.83 m/s²).

This test establishes the maximum accelerate-stop energy rating, KE_{RT} , of the wheel and brake assembly using:

- a. The Brake Rated Maximum Operating Pressure, $BROP_{MAX}$; or
- b. The maximum brake pressure consistent with the aeroplane's braking pressure limitations (e.g., tire/runway drag capability based on substantiated data).

3.3.3.2 For the accelerate-stop test, the tire, wheel, and brake assembly must be tested at KE_{RT} for both a new brake and a fully worn brake.

- (i) A new brake is defined as a brake on which less than 5 percent of the useable wear range of the heat sink has been consumed.
- (ii) A worn brake is defined as a brake on which the usable wear range of the heat sink has already been fully consumed to BRWL.

The proportioning of wear through the brake for the various friction pairs for this test must be based on service wear experience or wear test data of an equivalent or similar brake. Either operationally worn or mechanically worn brake components may be used. If mechanically worn components are used, it must be shown that they can be expected to provide similar results to operationally worn components. The test brake must be subjected to a sufficient number and type of stops to ensure that the brake's performance is representative of in-service use; at least one of these stops, with the brake near the fully worn condition, must be a Design Landing Stop.

3.3.3.3 At the time of brake application, the temperatures of the tire, wheel, and brake, particularly the heat sink, must, as closely as practicable, be representative of a typical in-service condition. Preheating by taxi stops is an acceptable means.

These temperatures must be based on a rational analysis of a braking cycle, taking into account a typical brake temperature at which an aeroplane may be dispatched from the ramp, plus a conservative estimate of heat sink temperature change during subsequent taxiing, and take-off acceleration, as appropriate.

Alternatively, in the absence of a rational analysis, the starting heat sink temperature must be that resulting from the application of 10 percent KE_{RT} to the tire, wheel and brake assembly initially at not less than normal ambient temperature (59°F/15°C).

3.3.3.4 A full stop demonstration is not required for the accelerate-stop test. The test brake pressure may be released at a test speed of up to 23 mph (10 m/s). In this case, the initial brakes-on speed must be adjusted such that the energy absorbed by the tire, wheel and brake assembly during the test is not less than the energy absorbed if the test had commenced at the specified speed and continued to zero ground speed.

3.3.3.5 Within 20 seconds of completion of the stop, or of the brake pressure release in accordance with paragraph 3.3.3.4, the brake pressure must be adjusted to the Brake Rated Maximum Parking Pressure, $BRPP_{MAX}$, and maintained for at least 3 minutes.

No sustained fire that extends above the level of the highest point of the tire is allowed before 5 minutes have elapsed after application of parking brake pressure; until this time has elapsed, neither firefighting means nor coolants may be applied.

The time of initiation of tire pressure release (e.g., by wheel fuse plug), if applicable, is to be recorded. The sequence of events described in paragraphs 3.3.3.4 and 3.3.3.5 is illustrated in figure 3-1.

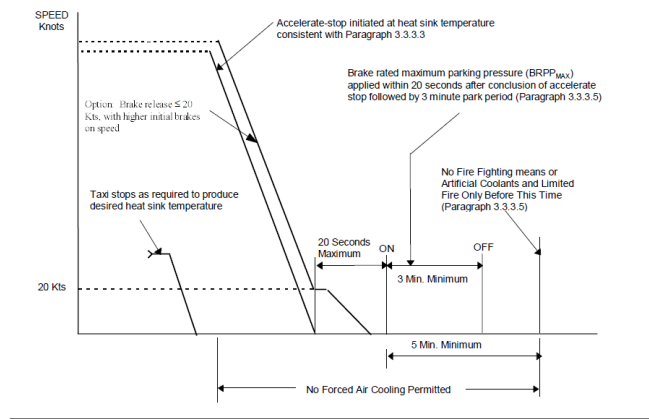

Figure 3.1 Taxi, accelerate-stop, park test sequence

3.3.4 Most Severe Landing Stop Test

3.3.4.1 The wheel and brake assembly under test must complete the most severe landing braking condition expected on the aeroplane as defined by the aeroplane manufacturer. This test is not required if the testing required by paragraph 3.3.3 is more severe or the condition is shown to be extremely improbable by the aeroplane manufacturer.

This test establishes, if required, the maximum energy rating, KE_{SS} , of the wheel/brake assembly for landings under abnormal conditions using:

- The Brake Rated Maximum Operating Pressure, $BROP_{MAX}$; or
- The maximum brake pressure consistent with an aeroplane's braking pressure limitations (e.g., tire/runway drag capability based on substantiated data).

3.3.4.2 For the Most Severe Landing Stop test, the tire, wheel and brake assembly must be capable of absorbing the test energy, KE_{SS} , with a brake on which the usable wear range of the heat sink has already been fully consumed to BRWL.

The proportioning of wear through the brake for the various friction pairs for this test must be based on service wear experience or wear test data of an equivalent or similar brake. Either operationally worn or mechanically worn brake components may be used. If mechanically worn components are used, it must be shown that they can be expected to provide similar results to operationally worn components. The test brake must be subjected to a sufficient number and type of stops to ensure that the brake's performance is representative of in-service use; at least one of these stops, with the brake near the fully worn condition, must be a Design Landing Stop.

3.3.4.3 At the time of brake application, the temperatures of the tire, wheel, and brake, particularly the heat sink, must, as closely as practicable, be representative of a typical in-service condition. Preheating by taxi stops is an acceptable means.

These temperatures must be based on a rational analysis of a braking cycle, taking into account a typical brake temperature at which the aeroplane may be dispatched from the ramp, plus a conservative estimate of heat sink temperature change during taxi, take-off, and flight, as appropriate.

Alternatively, in the absence of a rational analysis, the starting heat sink temperature must be that resulting from the application of 5 percent KERT to the tire, wheel and brake assembly initially at not less than normal ambient temperature (59°F/15°C).

3.3.4.4 A full stop demonstration is not required for the most severe landing-stop test. The test brake pressure may be released at a test speed of up to 20 knots. In this case, the initial brakes-on speed must be adjusted such that the energy absorbed by the tire, wheel, and brake assembly during the test is not less than the energy absorbed if the test had commenced at the specified speed and continued to zero ground speed.

3.3.4.5 Within 20 seconds of completion of the stop, or of the brake pressure release in accordance with paragraph 3.3.4.4, the brake pressure must be adjusted to the Brake Rated Maximum Parking Pressure, $BRPP_{MAX}$, and maintained for at least 3 minutes.

No sustained fire that extends above the level of the highest point of the tire is allowed before 5 minutes have elapsed after application of parking brake pressure; until this time has elapsed, neither firefighting means nor coolants may be applied.

The time of initiation of tire pressure release (e.g., by wheel fuse plug), if applicable, is to be recorded. The sequence of events described in paragraphs 3.3.4.4 and 3.3.4.5 is illustrated in Figure 3-2.

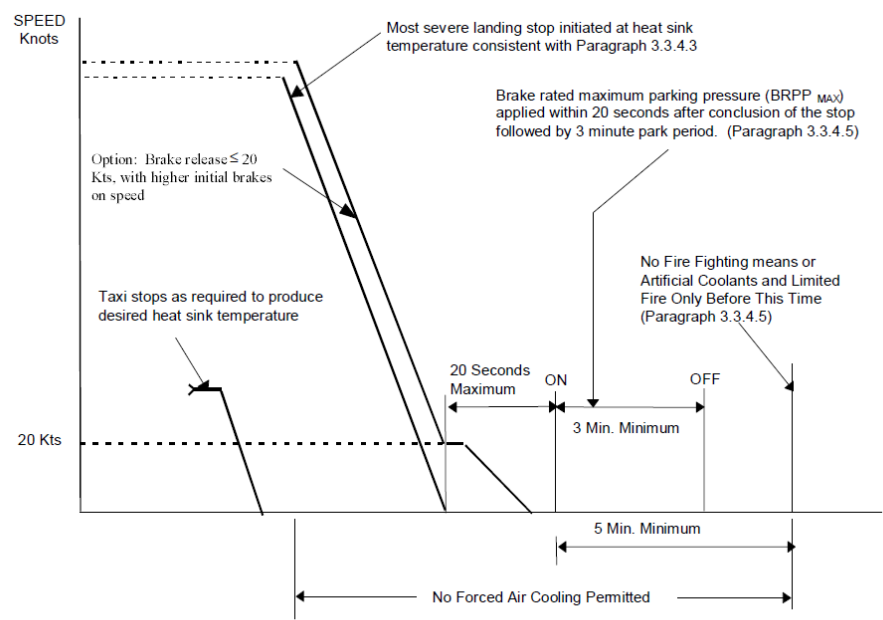

Figure 3.2. Most severe landing-stop, park test sequence

3.3.5 Structural Torque Test

The Wheel/Brake Rated Structural Torque, STR, is equal to the torque demonstrated in the test defined in 3.3.5.1.

3.3.5.1 Apply to the wheel, brake and tire assembly, the radial load S and the drag load corresponding to the torque specified in paragraph 3.3.5.2 or 3.3.5.3, as applicable, for at least 3 seconds. Rotation of the wheel must be resisted by a reaction force transmitted through the brake, or brakes, by the application of at least $BROP_{MAX}$, or equivalent. If such pressure or its equivalent is insufficient to prevent rotation, the friction surface may be clamped, bolted, or otherwise restrained while applying the pressure. A fully worn brake configuration, BRWL, must be used for this test. The proportioning of wear through the brake for the various friction pairs for this test must be based on service wear experience of an equivalent or similar brake or test machine wear test data. Either operationally worn or mechanically worn brake components may be used. An actuating fluid other than that specified for use on the aeroplane may be used for the structural torque test.

3.3.5.2 For landing gear with one wheel per landing gear strut, the torque is 1.2 (SxR).

3.3.5.3 For landing gear with more than one wheel per landing gear strut, the torque is 1.44 (SxR).

3.3.5.4 The wheel and brake assembly must support the loads without failure for at least 3 seconds.

3.4 BRAKE TESTS.

The brake assembly must be tested using the fluid (or other actuating means) specified for use with the brake on the aeroplane. It must be substantiated that standard production samples of the brake will pass the following tests:

3.4.1 Yield & Overpressure Test.

The brake must withstand a pressure equal to 1.5 times BRP_{MAX} for 5 minutes without permanent deformation of the structural components under test.

The brake, with actuator piston(s) extended to simulate a maximum worn condition, must, for at least 3 seconds, withstand hydraulic pressure equal to 2.0 times the Brake Rated Maximum Pressure, BRP_{MAX} , available to the brakes. If necessary, piston extension must be adjusted to prevent contact with retention devices during this test.

3.4.2 Endurance Test.

A brake assembly must be subjected to an endurance test during which structural failure or malfunction must not occur. If desired, the heat sink components may be replaced by a reasonably representative dummy mass for this test.

The test must be conducted by subjecting the brake assembly to 100,000 cycles of an application of the average of the peak brake pressures needed in the Design Landing Stop Test (paragraph 3.3.2) and release to a pressure not exceeding the Brake Rated Retraction Pressure, BRP_{RET} . The pistons must be adjusted so that 25,000 cycles are performed at each of the four positions where the pistons would be at rest when adjusted to nominally 25, 50, 75 and 100 percent of the wear limit, BRWL. The brake must then be subjected to 5000 cycles of application of pressure to BRP_{MAX} and release to BRP_{RET} at the 100 percent wear limit.

Hydraulic brakes must meet the leakage requirements of paragraph 3.4.5 at the completion of the test.

3.4.3 Piston Retention.

The hydraulic pistons must be positively retained without leakage at 1.5 times BRP_{MAX} for at least 10 seconds with the heat sink removed.

3.4.4 Extreme Temperature Soak Test

The brake actuation system must comply with the dynamic leakage limits of paragraph 3.4.5.2 for the following tests.

Subject the brake to at least a 24-hour hot soak at the maximum piston housing fluid temperature experienced during the Design Landing Stop Test (paragraph 3.3.2), conducted without forced air cooling. While at the hot soak temperature, the brake must be subjected to the application of the average of the peak brake pressures required during the 100 design landing stops and release to a pressure not exceeding BRP_{RET} for 1000 cycles, followed by 25 cycles of $BROP_{MAX}$ and release to a pressure not exceeding BRP_{RET} .

The brake must then be cooled from the hot soak temperature to a cold soak temperature of $-40^{\circ}F$ ($-40^{\circ}C$) and maintained at this temperature for at least 24 hours. While at the cold soak temperature, the brake must be subjected to the application of the average of the peak brake

pressures required during the KE_{DL} stops and release to a pressure not exceeding BRP_{RET} , for 25 cycles, followed by 5 cycles of $BROP_{MAX}$ and release to a pressure not exceeding BRP_{RET} .

3.4.5 Leakage Tests (Hydraulic Brakes).

3.4.5.1 Static Leakage Test.

The brake must be subjected to a pressure equal to 1.5 times BRP_{MAX} for at least 5 minutes. The brake pressure must then be adjusted to an operating pressure of 5 psig (35 kPa) for at least 5 minutes. There must be no measurable leakage (less than one drop) during this test.

3.4.5.2 Dynamic Leakage Test.

The brake must be subjected to 25 applications of BRP_{MAX} , each followed by the release to a pressure not exceeding BRP_{RET} . Leakage at static seals must not exceed a trace. Leakage at moving seals must not exceed one drop of fluid per each 3 inches (76mm) of peripheral seal length.

CHAPTER 4 DATA REQUIREMENTS.

4.1 The manufacturer must provide the following data with any application for approval of equipment.

4.1.1 The following wheel and brake assembly ratings:

a. Wheel Ratings.

Wheel Rated Static Load, S

Wheel Rated Inflation Pressure, WRP

Wheel Rated Tire Loaded Radius, R

Wheel Rated Maximum Limit Load, L

Wheel Rated Tire Size, TS_{WR}

b. Wheel/Brake and Brake Ratings.

Wheel/Brake Rated Design Landing Energy, KE_{DL} , and associated brakes-on-speed, V_{DL}

Wheel/Brake Rated Accelerate-Stop Energy, KE_{RT} , and associated brakes-on-speed, V_{RT}

Wheel/Brake Rated Most Severe Landing Stop Energy, KE_{SS} , and associated brakes on-speed, V_{SS} (if applicable).

Brake Rated Maximum Operating Pressure, $BROP_{MAX}$.

Brake Rated Maximum Pressure, BRP_{MAX} .

Brake Rated Retraction Pressure, BRP_{RET}

Wheel/Brake Rated Structural Torque, ST_R .

Rated Design Landing Deceleration, D_{DL} .

Rated Accelerate-Stop Deceleration, D_{RT} .

Rated Most Severe Landing Stop Deceleration, D_{SS} (if applicable).

Brake Rated Tire Size, TS_{BR} .

Brake Rated Wear Limit, BRWL

4.1.2 The weight of the wheel or brake, as applicable.

4.1.3 Specification of hydraulic fluid used, as applicable.

4.1.4 One copy of the test report showing compliance with the test requirements.

NOTE: When test results are being recorded for incorporation in the compliance test report, it is not sufficient to note merely that the specified performance was achieved. The actual numerical values obtained for each of the parameters tested must be recorded, except where tests are pass/fail in character.

– END –

EQUIVALENT SAFETY FINDING and IM	D-17 ESF & IM: Fuselage Doors
APPLICABILITY:	A380
REQUIREMENTS:	JAR 25.783, PNPA 25D-301
ADVISORY MATERIAL:	PNPA 25D-301

BACKGROUND

As a result of investigation of the airplane accident(s) associated with fuselage doors opening during flight, the National Transportation Safety Board (NTSB) issued Safety Recommendations relating to doors on transport category airplanes.

P-NPA 25D-301 revises the doors requirements of JAR 25.783 by incorporating changes developed in co-operation with the FAA and the Aviation Rulemaking Advisory Committee (ARAC) and provides the addition of ACJ 25.783, "Fuselage doors and hatches" material. P-NPA 25D-301 is intended to achieve common requirements and language between the JAR and FAR requirements and also make some of the requirements more rational, while enhancing the level of safety provided by the current requirements.

Airbus elected to show compliance with the provisions of P-NPA 25D-301 related to the safety of fuselage doors (ref. minutes of meeting 415.0247/01 dated 2 July 2001).

EQUIVALENT SAFETY FINDING

JAR-25 SECTION 1 SUBPART D - DESIGN AND CONSTRUCTION PERSONNEL AND CARGO ACCOMODATIONS

§ 25.783 Fuselage doors.

(See ACJ 25.783)

- (a) *General.* This section applies to fuselage doors, which includes all doors, hatches, openable windows, access panels, covers, etc., on the exterior of the fuselage that do not require the use of tools to open or close. This also applies to each door or hatch through a pressure bulkhead, including any bulkhead that is specifically designed to function as a secondary bulkhead under the prescribed failure conditions of part 25. These doors must meet the requirements of this section, taking into account both pressurized and unpressurized flight, and must be designed as follows:
- (1) Each door must have means to safeguard against opening in flight as a result of mechanical failure, or failure of each single structural element.
 - (2) Each door that could be a hazard if it unlatches must be designed so that unlatching during pressurized and unpressurized flight from the fully closed, latched, and locked condition is extremely improbable. This must be shown by safety analysis.
 - (3) Each element of each door operating system must be designed or, where impracticable, distinctively and permanently marked, to minimize the probability of incorrect assembly and adjustment that could result in a malfunction.
 - (4) All sources of power that could initiate unlocking or unlatching of each door must be automatically isolated from the latching and locking systems prior to flight and it must not be possible to restore power to the door during flight.
 - (5) Each removable bolt, screw, nut, pin, or other removable fastener must meet the locking requirements of § 25.607.

- (6) Certain doors, as specified by § 25.807(h), must also meet the applicable requirements of §§ 25.809 through 25.813 for emergency exits.
- (b) *Opening by persons.* There must be a means to safeguard each door against opening during flight due to inadvertent action by persons. In addition, design precautions must be taken to minimize the possibility for a person to open a door intentionally during flight. If these precautions include the use of auxiliary devices, those devices and their controlling systems must be designed so that:
- (i) no single failure will prevent more than one exit from being opened, and
 - (ii) failures that would prevent opening of the exit after landing are improbable.
- (c) *Pressurization prevention means.* There must be a provision to prevent pressurization of the airplane to an unsafe level if any door subject to pressurization is not fully closed, latched, and locked.
- (1) The provision must be designed to function after any single failure, or after any combination of failures not shown to be extremely improbable.
 - (2) Doors that meet the conditions described in § 25.783(h) are not required to have a dedicated pressurization prevention means if, from every possible position of the door, it will remain open to the extent that it prevents pressurization, or safely close and latch as pressurization takes place. This must also be shown with each single failure and malfunction except that:
 - (i) with failures or malfunctions in the latching mechanism, it need not latch after closing, and
 - (ii) with jamming as a result of mechanical failure or blocking debris, the door need not close and latch if it can be shown that the pressurization loads on the jammed door or mechanism would not result in an unsafe condition.
- (d) *Latching and locking.* The latching and locking mechanisms must be designed as follows:
- (1) There must be a provision to latch each door.
 - (2) The latches and their operating mechanism must be designed so that, under all airplane flight and ground loading conditions, with the door latched, there is no force or torque tending to unlatch the latches. In addition, the latching system must include a means to secure the latches in the latched position. This means must be independent of the locking system.
 - (3) Each door subject to pressurization, and for which the initial opening movement is not inward, must
 - (i) have an individual lock for each latch,
 - (ii) have the lock located as close as practicable to the latch, and
 - (iii) be designed so that, during pressurized flight, no single failure in the locking system would prevent the locks from restraining the latches as necessary to secure the door.
 - (4) Each door for which the initial opening movement is inward, and unlatching of the door could result in a hazard, must have a locking means to prevent the latches from becoming disengaged. The locking means must ensure sufficient latching to prevent opening of the door even with a single failure of the latching mechanism.
 - (5) Each door for which unlatching would not result in a hazard is not required to have a locking mechanism.
 - (6) It must not be possible to position the lock in the locked position if the latch and the latching mechanism are not in the latched position.
 - (7) It must not be possible to unlatch the latches with the locks in the locked position. Locks must be designed to withstand the limit loads resulting from
 - (i) the maximum operator effort when the latches are operated manually;
 - (ii) the powered latch actuators, if installed; and
 - (iii) the relative motion between the latch and the structural counterpart.

- (e) *Warning, caution, and advisory indications.* Doors must be provided with the following indications:
- (1) There must be a positive means to indicate at the door operator's station for each door that all required operations to close, latch, and lock the door have been completed.
 - (2) There must be a positive means clearly visible from the operator station for each door to indicate if the door is not fully closed, latched, and locked for each door that could be a hazard if unlatched.
 - (3) There must be a visual means on the flight deck to signal the pilots if any door is not fully closed, latched, and locked. The means must be designed such that any failure or combination of failures that would result in an erroneous closed, latched, and locked indication is improbable for —
 - (i) each door that is subject to pressurization and for which the initial opening movement is not inward, or
 - (ii) each door that could be a hazard if unlatched.
 - (4) There must be an aural warning to the pilots prior to or during the initial portion of takeoff roll if any door is not fully closed, latched, and locked, and its opening would prevent a safe takeoff and return to landing.
- (f) *Visual inspection provision.* Each door for which unlatching could be a hazard must have a provision for direct visual inspection to determine, without ambiguity, if the door is fully closed, latched, and locked. The provision must be permanent and discernible under operational lighting conditions, or by means of a flashlight or equivalent light source.
- (g) *Certain maintenance doors, removable emergency exits, and access panels.* Some doors not normally opened except for maintenance purposes or emergency evacuation and some access panels need not comply with certain paragraphs of this section as follows:
- (1) Access panels that are not subject to cabin pressurization and would not be a hazard if unlatched during flight need not comply with paragraphs (a) through (f) of this section, but must have a means to prevent inadvertent opening during flight.
 - (2) Inward-opening removable emergency exits that are not normally removed, except for maintenance purposes or emergency evacuation, and flight deck openable windows need not comply with paragraphs (c) and (f) of this section.
 - (3) Maintenance doors that meet the conditions of § 25.783(h), and for which a placard is provided limiting use to maintenance access, need not comply with paragraphs (c) and (f) of this section.
- (h) *Doors that are not a hazard.* For the purposes of this section, a door is considered not to be a hazard in the unlatched condition during flight, provided it can be shown to meet all of the following conditions:
- (1) Doors in pressurized compartments would remain in the fully closed position if not restrained by the latches when subject to a pressure greater than ½ psi. Opening by persons, either inadvertently or intentionally, need not be considered in making this determination.
 - (2) The door would remain inside the airplane or remain attached to the airplane if it opens either in pressurized or unpressurized portions of the flight. This determination must include the consideration of inadvertent and intentional opening by persons during either pressurized or unpressurized portions of the flight.
 - (3) The disengagement of the latches during flight would not allow depressurization of the cabin to an unsafe level. This safety assessment must include the physiological effects on the occupants.
 - (4) The open door during flight would not create aerodynamic interference that could preclude safe flight and landing.

- (5) The airplane would meet the structural design requirements with the door open. This assessment must include the aeroelastic stability requirements of § 25.629, as well as the strength requirements of this subpart.
- (6) The unlatching or opening of the door must not preclude safe flight and landing as a result of interaction with other systems or structures.

INTERPRETATIVE MATERIAL**JAR-25 SECTION 2 - ACCEPTABLE MEANS OF COMPLIANCE AND INTERPRETATIONS - ACJ**

Introduce a new Acceptable Means Of Compliance and Interpretations (ACJ 25.783) as follows:

ACJ 25.783**FUSELAGE DOORS - DESIGN, TEST, ANALYSIS AND CERTIFICATION**

- 1. PURPOSE.** This Acceptable Means Of Compliance and Interpretations, which is similar to the FAA Advisory Circular AC.783 sets forth acceptable means of compliance with the provisions of Part 25 of the Joint Aviation Requirements (JAR) dealing with the certification requirements for fuselage external doors and hatches.

The means of compliance described in this document is intended to provide guidance to supplement the engineering and operational judgement that must form the basis of any compliance findings relative to the structural and functional safety standards for doors and their operating systems

This document is issued to describe an acceptable means, but not the only means, for demonstrating compliance with the requirements for transport category aeroplanes. Terms such as “shall” and “must” are used only in the sense of ensuring applicability of this particular method of compliance when the acceptable method of compliance described in this document is used.

- 2. CANCELLATION.** JAR NPA25D-218 Rev. 2 dated May 1992, is cancelled.

- 3. RELATED JAR SECTIONS.** The contents of this advisory circular are considered by the JAA in determining compliance of doors with the safety requirements of § 25.783. Other related paragraphs are:

- § 25.571, “Damage-tolerance and fatigue evaluation of structure”
- § 25.607, “Fasteners”
- § 25.703, “Takeoff warning system”
- § 25.809, “Emergency exit arrangement”
- § 25.813, “Emergency exit access”

4. DEFINITIONS OF TERMS.

Inconsistent or inaccurate use of terms may lead to the installation of doors and hatches that do not fully meet the safety objectives of the regulations. To ensure that such installations fully comply with the regulations, the following definitions should be used when showing compliance with § 25.783:

- a. “Door” includes all doors, hatches, openable windows, access panels, covers, etc. on the exterior of the fuselage which do not require the use of tools to open or close. This also includes each door or hatch through a pressure bulkhead including any bulkhead that is specifically designed to function as a secondary bulkhead under the prescribed failure conditions of JAR 25.
- b. “Initial opening movement,” refers to that door movement caused by operation of a handle or other door control mechanism which is required to place the door in a position free of structure that would interfere with continued opening of the door.
- c. “Inward” means having a directional component of movement that is inward with respect to the mean (pressure) plane of the body cut-out.
- d. “Closed” means that the door has been placed within the door frame in such a position that the latches can be operated to the “latched” condition. “Fully closed” means that the door is

placed within the door frame in the position it will occupy when the latches are in the latched condition.

- e. “Latches” are movable mechanical elements that, when engaged, prevent the door from opening.
- f. “Latched” means the latches are engaged with their structural counterparts and held in position by the latch operating mechanism.
- g. “Latching system” means the latch operating system and the latches.
- h. “Locks” are mechanical elements in addition to the latch operating mechanism that monitor the latch positions, and when engaged, prevent latches from becoming disengaged.
- i. “Locked” means the locks are engaged.
- j. “Locking system” means the lock operating system and the locks.
- k. “Stops” are fixed structural elements on the door and door frame, which when in contact, limit the directions in which the door is free to move.
- l. “Exit” is a door designed to allow egress from the aeroplane.
- m. “Emergency exit” is an exit designated for use in an emergency evacuation.
- n. “Flight” refers to that time from start of take-off roll until the aeroplane comes to rest after landing.
- o. “Door operator’s station” means the location(s) where the door closing, latching and locking operations are performed.
- p. “Inadvertent action by persons” means an act committed without forethought, consideration or consultation.

5. BACKGROUND.

History of incidents and accidents.

There is a history of incidents and accidents in which doors, fitted in pressurised aeroplanes, have opened during pressurised and unpressurised flight. Some of these inadvertent openings have resulted in fatal crashes. After one fatal accident that occurred in 1974, the FAA and industry representatives formed a design review team to examine the current regulatory requirements for doors to determine if those regulations were adequate to ensure safety. The team’s review and eventual recommendations led to the FAA issuing Amendment 25-54 to 14 CFR part 25 in 1980, that was adopted by the JAA in JAR-25 Change 10 in 1983, which significantly improved the safety standards for doors installed on transport category aeroplanes. Included as part of JAR-25 Change 10 (Amendment 25-54) was § 25.783, “Doors,” which provides the airworthiness standards for doors installed on transport category airplanes.

Although there have been additional minor revisions to § 25.783 subsequent to the issuance of Change 10 (Amendment 25-54), the safety standards for doors have remained essentially the same since 1980.

Continuing safety problems

In spite of the improved standards brought about in 1980, there have continued to be safety problems, especially with regard to cargo doors. Cargo doors are often operated by persons having little formal instruction in their operation. Sometimes the operator is required to carry out several actions in sequence to complete the door opening and closing operations. Failure to complete all sequences during closure can have serious consequences. Service history shows that several incidents of doors opening during flight have been attributed to the failure of the operator to complete the door closure and locking sequence. Other incidents have been attributable to incorrect adjustment of the door mechanism, or failure of a vital part.

Indication to the flight crew.

Experience also has shown that, in some cases, the flight deck indication system has not been reliable. In other instances, the door indication system was verified to be indicating correctly, but the flight crew, for unknown reasons, was not alerted to the unsafe condition. A reliable indication of door status on the flight deck is particularly important on airplanes used in operations where the

flight crew does not have an independent means readily available to verify that the doors are properly secured.

Large cargo doors as basic airframe structure.

On some airplanes, large cargo doors form part of the basic fuselage structure, so that, unless the door is properly closed and latched, the basic airframe structure is unable to carry the design aerodynamic and inertial loads. Large cargo doors also have the potential for creating control problems when an open door acts as an aerodynamic surface. In such cases, failure to secure the door properly could have catastrophic results, even when the airplane is unpressurised.

NTSB (USA) recommendations.

After two accidents occurred in 1989 that were related to the failure of cargo doors on transport category airplanes, the FAA chartered the Air Transport Association (ATA) of America to study the door design and operational issues again for the purpose of recommending improvements. The ATA concluded its study in 1991 and made recommendations to the FAA for improving the design standards of doors. Those recommendations and additional recommendations from the National Transportation Safety Board (NTSB) were considered in the development of improved standards for doors adopted by Amendment 25-XXX (JAR-25 Change-XX).

6. DISCUSSION OF THE CURRENT REQUIREMENTS.

Service history has shown that to prevent doors from becoming a hazard by opening in flight, it is necessary to provide multiple layers of protection against failures, malfunctions, and human error. Section 25.783 addresses these multiple layers of protection by requiring:

- a latching system
- a locking system,
- indication systems,
- a pressure prevention means.

These features provide a high degree of tolerance to failures, malfunctions, and human error. Section 25.783 intends that the latching system be designed so that it is inherently or specifically restrained from being back driven from the latches; but even so, the latches are designed to eliminate, as much as possible, all forces from the latch side that would tend to unlatch the latches. In addition to these features that prevent the latches from inadvertently opening, a separate locking system is required for doors that could be a hazard if they become unlatched. Notwithstanding these safety features, it could still be possible for the door operator to make errors in closing the door, or for mechanical failures to occur during or after closing; therefore, an indicating system is required that will signal to the flight crew if the door is not fully closed, latched, and locked. However, since it is still possible for the indication to be missed or unheeded, a separate system is required that prevents pressurization of the airplane to an unsafe level if the door is not fully closed, latched, and locked.

The following material restates the requirements of § 25.783 in italicized text and, immediately following, provides a discussion of acceptable compliance criteria.

§25.783(a) General Design Considerations.

This section applies to fuselage doors, which includes all doors, hatches, openable windows, access panels, covers, etc., on the exterior of the fuselage that do not require the use of tools to open or close. This also applies to each door or hatch through a pressure bulkhead, including any bulkhead that is specifically designed to function as a secondary bulkhead under the prescribed failure conditions of part 25. These doors must meet the requirements of this section, taking into account both pressurized and unpressurised flight, and must be designed as follows:

(1) Each door must have means to safeguard against opening in flight as a result of mechanical failure, or failure of a single structural element.

Failures that should be considered when safeguarding the door against opening as a result of mechanical failure or failure of a single structural element include those caused by wear, excessive backlash, excessive friction, jamming, incorrect assembly, incorrect adjustment and parts becoming loose, disconnected, or unfastened, in addition to failures due to parts breaking, fracturing, bending or flexing beyond that intended.

(2) Each door that could be a hazard if it unlatches must be designed so that unlatching during pressurized and unpressurized flight from the fully closed, latched, and locked condition is extremely improbable. This must be shown by safety analysis .

All doors should incorporate features in the latching mechanism that provide a positive means to prevent the door from opening as a result of vibrations, structural loads and deflections, positive and negative pressure loads, positive and negative 'g' loads, aerodynamic loads etc. The means should be effective throughout the approved operating envelope of the aeroplane including the unpressurized portions of flight.

The safety assessment required by this regulation may be a qualitative or quantitative analysis, or a combination as appropriate to the design. In evaluating a failure condition that results in total failure or inadvertent opening of the door, all contributing events should be considered, including failure of the door and door supporting structure, flexibility in structures and linkages, failure of the operating system, erroneous signals from the door indication systems and likely errors in operating and maintaining the door.

(3) Each element of each door operating system must be designed or, where impracticable, distinctively and permanently marked, to minimise the probability of incorrect assembly and adjustment that could result in a malfunction.

Experience has shown that the level of protection against mechanical failure can be significantly improved by careful attention to detail design. The following points should therefore be taken into account:

(a) To minimize the risk of incorrect assembly and adjustment, parts should be designed to prevent incorrect assembly if, as a result of such incorrect assembly, door functioning would be adversely affected. "Adverse effects" could be such things as preventing or impeding the opening of the door during an emergency, or reducing the capability of the door to remain closed. If such designs are impracticable and marking is used instead, the marking should remain clearly identifiable during service. In this respect, markings could be made using material such as permanent ink, provided it is resistant to typical solvents, lubricants, and other materials used in normal maintenance operations.

(b) To minimize the risk of the door operating mechanism being incorrectly adjusted in service, adjustment points that are intended for "in-service" use only should be clearly identified, and limited to a minimum number consistent with adequate adjustment capability. Any points provided solely to facilitate adjustment at the initial build and not intended for subsequent use, should be made non-adjustable after initial build, or should be highlighted in the maintenance manual as a part of the door mechanism that is not intended to be adjusted.

(4) All sources of power that could initiate unlocking or unlatching of each door must be automatically isolated from the latching and locking systems prior to flight and it must not be possible to restore power to them during flight.

For doors that use electrical, hydraulic, or pneumatic power to initiate unlocking or unlatching, those power sources must be automatically isolated from the latching and locking systems before flight, and it should not be possible to restore power to them during flight. It is particularly important for doors with powered latches or locks to have all power removed that could power these systems or that could energize control circuits to these systems in the event of electrical short circuits. This does not include power to the door indicating system, auxiliary securing devices if installed, or other systems not related to door operation. Power to those systems should not be sufficient to cause unlocking or unlatching unless each failure condition that could result in energizing the latching and locking systems is extremely improbable.

(5) Each removable bolt, screw, nut, pin, or other removable fastener must meet the locking requirements of § 25.607. [Fasteners] .

Refer to ACJ 25.607 for guidance on complying with § 25.607.

(6) Certain fuselage doors, as specified by 25.807(h), must also meet the applicable requirements of §§25.809 through 25.813 for emergency exits.

§25.783(b) Opening by persons.

There must be means to safeguard each door against opening during flight due to inadvertent action by persons.

The door should have inherent design features that achieve this objective. It is not considered acceptable to rely solely on cabin pressure to prevent inadvertent opening of doors during flight, because there have been instances where doors have opened during unpressurized flight, such as during landing. Therefore all doors should incorporate features to prevent the door from being opened inadvertently by persons on board.

In addition, precautions must be taken to minimise the possibility for a person to open a door intentionally during flight. If these precautions include the use of auxiliary devices, they must be designed so that a single failure will not prevent more than one exit from being opened.

The intentional opening of a door by persons on board while the aeroplane is in flight should be considered. This rule is intended to protect the aircraft and passengers but not necessarily the person who intentionally tries to open the door. Suitable design precautions should therefore be taken; however, the precautions should not compromise the ability to open an emergency exit in an emergency evacuation. The following precautions should be considered:

(a) For doors in pressurised compartments: it should not normally be possible to open the door when the compartment differential pressure is above 2 psi. The ability to open the door will depend on the door operating mechanism and the handle design, location and operating force. Operating forces in excess of 300 pounds should be considered sufficient to prevent the door from being opened. During approach, takeoff and landing when the compartment differential pressure is lower, it is recognised that intentional opening may be possible; however, these phases are brief and all passengers are expected to be seated with seat belts fastened.

(b) For doors that cannot meet the guidance of 6.b.(2)(a), above, and for doors in non-pressurised aeroplanes: The use of auxiliary devices (for example, a speed-activated or barometrically-activated means) to safeguard the door from opening in flight should be considered. The need for such auxiliary devices should depend upon the consequences to the aeroplane and other occupants if the door is opened in flight.

(c) If auxiliary devices are installed on emergency exits: The failure of an auxiliary device should normally result in an unsecured position of the device. Failures of the device that would prevent opening of the exit after landing should be improbable. Where auxiliary devices are controlled by a central system or other more complex systems, a single failure criterion for opening may not be sufficient. The criteria for failure of the auxiliary devices to open after landing should include consideration of single failures and all failure conditions that are not improbable.

§25.783(c) Pressurisation prevention means.

There must be a provision to prevent pressurisation of the aeroplane to an unsafe level if any door subject to pressurisation is not fully closed, latched, and locked.

(1) The provision must be designed to function after any single failure, or after any combination of failures not shown to be extremely improbable.

(a) The provisions for preventing pressurisation must monitor the closed, latched and locked condition of the door. If more than one lock system is used, each lock system must be monitored. Examples of such provisions are vent panels and pressurisation inhibiting circuits. Pressurisation to an unsafe level is considered to be prevented when the pressure is kept below 1/2 psi. These systems are not intended to function to depressurize the aeroplane once the fully closed latched and locked condition is established and pressurisation is initiated.

(b) If a vent panel is used, it should be designed so that, in normal operation or with a single failure in the operating linkage, the vent panel cannot be closed until the door is latched and locked. The vent panel linkage should monitor the position of each door lock.

(c) If automatic control of the cabin pressurisation system is used as a means to prevent pressurisation, the control system should monitor each lock. Because inadvertent depressurization at altitude can be hazardous to the occupants, this control system should be considered in showing compliance with the applicable pressurisation system reliability requirements. Normally, such systems should be automatically disconnected from the aeroplane's pressurisation system after the aeroplane is airborne, provided no prior unsafe condition was detected.

(d) It should not be possible to override the pressurisation prevention system unless a procedure is defined in the Master Minimum Equipment List (MMEL) that confirms a fully closed, latched and locked condition. In order to prevent the override procedure from becoming routine, the override condition should not be achievable by actions solely on the flight deck and should be automatically reset at each door operational cycle.

(2) Doors that meet the conditions described in § 25.783(h) are not required to have a dedicated pressurization prevention means if, from every possible position of the door, it will remain open to the extent that it prevents pressurization, or close and latch as pressurization takes place. This must also be shown with each single failure or malfunction except that:

- (i)) with failures or malfunctions in the latching mechanism, it need not latch after closing, and
- (ii) jamming as a result of mechanical failure or blocking debris, the door need not close and latch if it can be shown that the pressurization loads on the jammed door or mechanism would not result in an unsafe condition.

As specified in § 25.783(d)(5), each door for which unlatching would not result in a hazard is not required to have a locking mechanism; those doors also may not be required to have a dedicated pressurization prevention means. However, this should be determined by demonstrating that an unsafe level of pressurization cannot be achieved for each position that the door may take during closure, including those positions that may result from single failures or jams.

- Excluding jamming and excluding failures and malfunctions in the latching system, for every possible position of the door, it must either remain open to the extent that it prevents pressurization, or safely close and latch as pressurization takes place.
- With single failures of the latching system or malfunctions in the latching system the door may not necessarily be capable of latching, but it should either remain open to the extent that it prevents pressurization, or safely move to the closed position as pressurization takes place; and
- With jamming as a result of mechanical failure in the latching system or blocking debris, the pressurization loads on the jammed door or mechanism may not result in damage to the door or airframe that could be detrimental to safe flight (both the immediate flight or future flights). In this regard, consideration should be given to jams or non-frangible debris that could hold the door open just enough to still allow pressurization, and then break loose in flight after full pressurization is reached.

§25.783(d) Latching and locking

The latching and locking mechanisms must be designed as follows:

(1) There must be a provision to latch each door.

Latches are movable mechanical elements that, when engaged, prevent the door from opening.

(a) The definitions of latches and locks are redefined in chapter 4 [Definitions], particularly in regard to mechanical and structural elements of inward-opening plug doors. In this regard, fixed stops are not considered latches. The movable elements that hold the door in position relative to

the fixed stops are considered latches. These movable elements prevent the door from opening and will support some loads in certain flight conditions, particularly when the aeroplane is unpressurized.

(b) For all doors, paragraph 25.783(d)(2) requires that the latching system employ a securing means other than the locking system. The separate locking system may not be necessary for certain inward-opening plug doors [see § 25.783(d)(5)].

(2) The latches and their operating mechanism must be designed so that, under all aeroplane flight and ground loading conditions, with the door latched, there is no force or torque tending to unlatch the latches. In addition, the latching system must include a means to secure the latches in the latched position. This means must be independent of the locking system.

The latches of doors for which the initial opening movement is outward are typically subject to vibrations; structural loads and deflections; positive and negative pressure loads; positive and negative 'g' loads; aerodynamic loads; etc. The latches of doors for which the initial opening movement is inward typically share some of these loads with fixed stops. Doors for which the initial opening movement is inward tend to be resistant to opening when the aircraft is pressurized since a component of the pressure load tends to hold the door closed. In order for a design to be classified as having an inward initial opening movement, it should be shown that the provisions provided to guide the door inward have sufficient rigidity and strength to fulfill their function with a pressure of at least 2 psi applied to the door.

(a) Latch design. The design of the latch should be such that with the latch disconnected from its operating mechanism, the net reaction forces on the latch should not tend to unlatch the latch during both pressurised and unpressurised flight throughout the approved flight envelope. The effects of possible friction in resisting the forces on the latch should be ignored when considering reaction forces tending to unlatch the door. The effects of distortion of the latch and corresponding structural attachments should be taken into account in this determination. Any latch element for which 'g' loads could result in an unlatching force should be designed to minimise such forces.

(b) Latch securing means. Even though the principal back-driving forces should be eliminated by design, it is recognised that there may still be ratcheting forces that could progressively move the latches to the unlatched position. Therefore, each latch should be positively secured in the latched position by its operating mechanism, which should be effective throughout the approved flight envelope. The location of the operating system securing means will depend on the rigidity of the system and the tendency for any forces (such as ratcheting, etc.) at one latch to unlatch other latches.

(c) Overcenter features in the latching mechanism are considered to be an acceptable securing means, provided that an effective retaining feature that functions automatically to prevent back-driving is incorporated. If the design of the latch is such that it could be subject to ratcheting loads which might tend to unlatch it, the securing means should be adequate to resist such loads.

(d) Back-driving effect of switches. In those designs that use the latch to operate an electrical switch, any back-driving effect of the switch on the latch is permissible, provided that the extent of any possible movement of the switch

* is insufficient to unlatch it, and

* will not result in the latch being subjected to any other force or torque tending to unlatch it.

(e) The latch securing means must be independent of the locking means. However, the latching and locking functions may be fulfilled by a single operating means, provided that it is not possible to back-drive the locks via the latch mechanism when the door is locked.

(3) Each door subject to pressurisation, and for which the initial opening movement is not inward must --

(i) have an individual lock for each latch,

(ii) have the lock located as close as practicable to the latch, and

(iii) be designed so that in pressurised flight, no single failure in the locking system would prevent the locks from restraining the latches as necessary to secure the door.

(a) To safeguard doors subject to pressurisation and for which the initial opening movement is not inward, each latch must have an individual lock. The lock should directly lock the latch. In this regard, the lock should be located directly at the latch to ensure that, in the event of a single failure in the latch operating mechanism, the lock would continue to restrain the latch in the latched position. Even in those cases where the lock cannot be located directly at the latch, the same objective should be achieved. In some cases, a pair of integrally-connected latches may be treated as a single latch with respect to the requirement for a lock provided that:

1 the lock reliably monitors the position of at least one of the load carrying elements of the latch, and

2 with any one latch element missing, the aeroplane can meet the full requirements of JAR-25 as they apply to the unfailed aeroplane, and

3 with the pair disengaged, the aeroplane can achieve safe flight and landing, and meet the damage tolerance requirements of § 25.571[Damage-tolerance and fatigue evaluation of structure].

(b) In some designs more latches are provided than necessary to meet the minimum design requirements. The single failure requirement for the locking system is intended to ensure that the number and combination of latches necessary to secure the door will remain restrained by the locking mechanism. Only those latches needed to meet the minimum design requirements need to remain restrained after the single failure.

(c) In meeting this requirement, the indirect locking provided through the latch system by the locks at other latches may be considered. In this case, the locking system and the latching system between the locked latch and the unlocked latch should be designed to withstand the maximum design loads discussed in paragraph 6.d.(7) of this ACJ, below, as appropriate to pressurised flight.

(4) Each door for which the initial opening movement is inward, and unlatching of the door could result in a hazard, must have a locking means to prevent the latches from becoming disengaged. The locking means must ensure sufficient latching to prevent opening of the door even with a single failure in the latching mechanism.

On these doors, the locking means should monitor the latch securing means, but need not directly monitor and lock each latch. Additionally, the locking means could be located such that all latches are locked by locking the latching mechanism. With any single failure in the latching mechanism, the means must still lock a sufficient number of latches to ensure that the door remains safely latched.

(5) Each door for which unlatching would not result in a hazard is not required to have a locking mechanism.

See paragraph 6.(h) of this ACJ, below, for a description of the kinds of doors for which unlatching is considered not to result in a safety hazard.

(6) It must not be possible to position the lock in the locked position if the latch and the latching mechanism are not in the latched position.

The lock should be an effective monitor of the position of the latch such that, if any latch is unlatched, the complete locking system cannot be moved to the locked position. Although an overcenter feature may be an adequate means of securing the latching mechanism, it is not considered to be the locking means for the latches.

(7) It must not be possible to unlatch the latches with the locks in the locked position. Locks must be designed to withstand the limit loads resulting from

- (i) the maximum operator effort when the latches are operated manually;
- (ii) the powered latch actuators, if installed; and

(iii) the relative motion between the latch and the structural counterpart.

Although the locks are not the primary means of keeping the latches engaged, they must have sufficient strength to withstand any loads likely to be imposed during all approved modes of door operation. The operating handle loads on manually-operated doors should be based on a rational human factors evaluation. However, handle forces in excess of 300 pounds need not be considered. The loads imposed by the normal powered latch actuators are generally predictable; however, loads imposed by alternate drive systems are not. For this reason the locks should have sufficient strength to react the stall forces of the latch drive system. Load-limiting devices should be installed in any alternate drive system for the latches in order to protect the latches and the locks from overload conditions. If the design of the latch is such that it could be subject to ratcheting loads which might tend to unlatch it, the locks should be adequate to resist such loads with the latch operating system disconnected from the latch.

§25.783(e) Warning, caution and advisory indications.

Doors must be provided with the following indications:

(1) There must be a positive means to indicate at the door operator's station for each door that all required operations to close, latch, and lock the door have been completed.

In order to minimise the probability of incomplete door operations, it should be possible to perform all operations for each door at one station. If there is more than one operator's station for a single door, appropriate indications should be provided at each station. The positive means to indicate at the door operator's station that all required operations have been completed are such things as final handle positions or indicating lights. This requirement is not intended to preclude or require a single station for multiple doors.

(2) There must be a positive means clearly visible from the door operator's station for each door to indicate if the door is not fully closed, latched, and locked for each door that could be a hazard if unlatched.

A single indication that directly monitors the door in the closed, latched and locked conditions should be provided, unless the door operator has a visual indication that the door is fully closed latched and locked. This indication should be obvious to the door operator. For example, a vent door or indicator light that monitors the door locks and is located at the operator's station may be sufficient.

(3) There must be a visual means on the flight deck to signal the pilots if any door is not fully closed, latched, and locked. The means must be designed such that any failure or combination of failures that would result in an erroneous closed, latched, and locked indication is improbable for —

(i) each door that is subject to pressurization and for which the initial opening movement is not inward, or

(ii) each door that could be a hazard if unlatched.

The visual means may be a simple amber light or it may need to be a red warning tied to the master warning system depending on the criticality of the door. The door closed, latched and locked functions must be monitored, but only one indicator is needed to signal the door closed, latched and locked condition. Indications should be reliable to ensure they remain credible. The probability of erroneous closed, latched, and locked indication should be no greater than 0.00001 for

- each door subject to pressurisation and for which the initial opening movement is not inward and for
- each door that could be a hazard if unlatched.

(4) There must be an aural warning to the pilots prior to or during the initial portion of takeoff roll if any door is not fully closed, latched, and locked and its opening would prevent safe takeoff and return to landing.

Where an unlatched door could open and prevent a safe takeoff and return to landing, a more conspicuous aural warning is needed. It is intended that this system should function in a manner similar to the takeoff configuration warning systems of § 25.703 [Takeoff Warning system]. The visual display for these doors may be either a red light or a display on the master warning system. Examples of doors requiring these aural warnings are

- doors for which the structural integrity of the fuselage would be compromised if the door is not fully closed, latched and locked, or
- doors that, if open, would prevent rotation or interfere with controllability to an unacceptable level.

§25.783(f) Visual inspection provision.

Each door, for which unlatching could be a hazard, must have provisions for direct visual inspection to determine, without ambiguity, if the door is fully closed, latched, and locked. The provision must be permanent and discernible under operational lighting conditions or by means of a flashlight or equivalent light source.

A provision is necessary for direct visual inspection of the closed position of the door and the status of each of the latches and locks, because dispatch of an aeroplane may be permitted in some circumstances when a flight deck or other remote indication of an unsafe door remains after all door closing, latching and locking operations have been completed. Because the visual indication is used in these circumstances to determine whether to permit flight with a remote indication of an unsafe door, the visual indication should have a higher level of integrity than, and be independent of, the remote indication.

(a) The provisions should:

1. allow direct viewing of the position of the locks to show, without ambiguity, whether or not each latch is latched and each lock is in the locked position. For doors which do not have a lock for each latch, direct viewing of the position of the latches and restraining mechanism may be necessary for determining that all the latches are latched. Indirect viewing, such as by optical devices or indicator flags, may be acceptable provided that there is no failure mode that could allow a false latched or locked indication.
2. preclude false indication of the status of the latches and locks as a result of changes in the viewing angle. The status should be obvious without the need for any deductive processes by the person making the assessment.
3. be of a robust design so that, following correct rigging, no unscheduled adjustment is required. Furthermore, the design should be resistant to unauthorised adjustment.
4. preclude mis-assembly that could result in a false latched and locked indication.

(b) If markings are used to assist the identification of the status of the latches and locks, such markings must include permanent physical features to ensure that the markings will remain accurately positioned.

(c) Although the visual means should be unambiguous in itself, placards and instructions may be necessary to interpret the status of the latches and locks.

(d) If optical devices or windows are used to view the latches and locks, it should be demonstrated that they provide a clear view and are not subject to fogging, obstruction from dislodged material or giving a false indication of the position of each latch and lock. Such optical devices and window materials should be resistant to scratching, crazing and any other damage from all materials and fluids commonly used in the operation and cleaning of aeroplanes.

§25.783(g) Certain maintenance doors, removable emergency exits, and access panels.

Some doors not normally opened except for maintenance purposes or emergency evacuation and some access panels need not comply with certain paragraphs of this section as follows:

(1) Access panels that are not subject to cabin pressurization and would not be a hazard if unlatched during flight need not comply with paragraphs (a) through (f) of this section, but must have a means to prevent inadvertent opening during flight.

(2) Inward-opening removable emergency exits that are not normally removed, except for maintenance purposes or emergency evacuation, and flight deck openable windows need not comply with paragraphs (c) and (f) of this section.

(3) Maintenance doors that meet the conditions of § 25.783(h), and for which a placard is provided limiting use to maintenance access, need not comply with paragraphs (c) and (f) of this section.

Some doors not normally opened except for maintenance purposes or emergency evacuation and some access panels are not required to comply with certain paragraphs of § 25.783 as described in § 25.783(g). This generally pertains to access panels outside pressurised compartments whose opening is of little or no consequence to safety and doors that are not used in normal operation and so are less subject to human errors or operational damage.

§25.783(h) Doors that are not a hazard.

For the purpose of this section, a door is considered not to be a hazard in the unlatched condition during flight, provided it can be shown to meet all of the conditions as mentioned in §25.783(h).

JAR 25.783 recognizes four categories of doors:

- Doors for which the initial opening is not inward, and are presumed to be hazardous if they become unlatched.
- Doors for which the initial opening is inward, and could be a hazard if they become unlatched.
- Doors for which the initial opening is inward, and would not be a hazard if they become unlatched.
- Small access panels outside pressurized compartments for which opening is of little or no consequence to safety.

JAR 25.783(h) describes those attributes that are essential before a door in the normal (unfailed) condition can be considered not to be a hazard during flight.

7. STRUCTURAL REQUIREMENTS.

The door structure, including its mechanical features (such as hinges, stops, and latches) that can be subjected to airframe loading conditions, must be designed either to the damage-tolerance requirements of § 25.571 (amendment 25 45 or later), or to the earlier fail safe requirements, depending on the certification basis of the aeroplane. In assessing the extent of damage under § 25.571 and § 25.783, consideration must be given to single element failures in the primary door structure such as: frames, stringers, intercostals, latches, hinges, stops, and stop supports.

The skin panels on doors that must comply with § 25.571, amendment 25 45 or later, should be designed to be damage-tolerant, with a high probability of detecting any crack before the crack causes door failure or cabin depressurisation. The obvious partial failure criteria or the damage tolerance criteria may be used for the design of skin panels on doors with an earlier certification basis.

– END –

EQUIVALENT SAFETY FINDING and IM	D-19 ESF &IM: Casting factors
APPLICABILITY:	A380
REQUIREMENTS:	JAR 25.621
ADVISORY MATERIAL:	N/A

BACKGROUND

Current JAR 25.621 “Casting Factors” states that “The approved national standards of the participants are accepted by the Authorities as alternatives to FAR 25.621”.

Airbus has requested an Equivalent Safety Finding to JAR 25.621 at change 15 and proposes to show compliance to JAR 25.621 using the harmonised position between JAA and FAA as established within the ARAC General Structures Harmonisation Working Group.

The equivalent safety finding is necessary due to the fact that JAR 25.621 had no specific requirement covering castings and this ESF proposes the introduction of a new requirement that takes account of advances in casting technology.

EQUIVALENT SAFETY FINDING

In lieu of § 25.621 “Casting Factors” the following apply:

JAR 25.621 Casting factors.

- (a) *General*. For castings used in structural applications, the factors, tests, and inspections specified in sub-paragraphs (b) through (d) of this paragraph must be applied in addition to those necessary to establish foundry quality control. The inspections must meet approved specifications.

Sub-paragraphs (c) and (d) of this paragraph apply to any structural castings except castings that are pressure tested as parts of hydraulic or other fluid systems and do not support structural loads.

- (b) *Bearing stresses and surfaces*. The casting factors specified in sub-paragraph (c) of this paragraph-

- (1) Need not exceed 1.25 with respect to bearing stresses regardless of the method of inspection used; and
- (2) Need not be used with respect to the bearing surfaces of a part whose bearing factor is larger than the applicable casting factor.

- (c) *Critical castings*. Each casting whose failure could preclude continued safe flight and landing of the aeroplane or could result in serious injury to occupants is considered a critical casting. Examples of castings that may be critical are: structural attachment fittings; parts of flight control systems; control surface hinges and balance weight attachments; seat, berth, safety belt, fuel, and oil tank supports and attachments; pressurised doors; and cabin pressure valves. Each critical casting must have a factor associated with it for showing compliance with strength and deformation requirements, and must comply with the following criteria associated with that factor:

- (1) A casting factor of greater than or equal to 1.0 but less than 1.25 may be used, provided that:
 - (i) It is demonstrated, in the form of process qualification, proof of product, and process monitoring that, for each casting design, the castings produced by each foundry and process combination have coefficients of variation of the

material properties that are equivalent to those of wrought alloy products of similar composition. Process monitoring must include testing of coupons cut from the prolongations of each casting (or each set of castings, if produced from a single pour into a single mould in a runner system) and, on a sampling basis, coupons cut from critical areas of production castings.

- (ii) Each casting receives:
 - (A) Inspection of 100 percent of its surface, using visual and liquid penetrant, or equivalent, inspection methods; and
 - (B) Inspection of structurally significant internal areas and areas where defects are likely to occur, using radiographic, or equivalent, inspection methods.
 - (iii) One casting undergoes a static test and is shown to meet the strength and deformation requirements of § 25.305.
- (2) A casting factor of greater than or equal to 1.25 but less than 1.50 may be used, provided that:
- (i) Each casting receives:
 - (A) Inspection of 100 percent of its surface, using visual and liquid penetrant, or equivalent inspection methods; and
 - (B) Inspection of structurally significant internal areas and areas where defects are likely to occur, using radiographic, or equivalent, inspection methods.
 - (ii) Three castings undergo a static tests and are shown to meet:
 - (A) The strength requirements of § 25.305 at an ultimate load corresponding to a casting factor of 1.25; and
 - (B) The deformation requirements of § 25.305 at a load of 1.15 times the limit load.
- (3) A casting factor of 1.50 or greater may be used, provided that:
- (i) Each casting receives:
 - (A) Inspection of 100 percent of its surface, using visual and liquid penetrant, or equivalent, inspection methods; and
 - (B) Inspection of structurally significant internal areas and areas where defects are likely to occur, using radiographic, or equivalent, inspection methods.
 - (ii) One casting undergoes a static test and is shown to meet:
 - (A) The strength requirements of § 25.305 at an ultimate load corresponding to a casting factor of 1.50; and
 - (B) The deformation requirements of § 25.305 at a load of 1.15 times the limit load.
- (d) *Noncritical castings*. For each casting other than critical castings, as specified in subparagraph (c) of this paragraph, the following apply:
- (1) A casting factor of greater than or equal to 1.0 but less than 1.25 may be used, provided that the requirements of (c)(1) of this paragraph are met, or:
 - (i) Castings are manufactured to approved specifications that specify the minimum mechanical properties of the material in the casting and provides for demonstration of these properties by testing of coupons cut from the castings on a sampling basis.
 - (ii) Each casting receives:
 - (A) Inspection of 100 percent of its surface, using visual and liquid penetrant, or equivalent, inspection methods; and

- (B) Inspection of structurally significant internal areas and areas where defects are likely to occur, using radiographic, or equivalent, inspection methods.
 - (iii) Three sample castings undergo static tests and are shown to meet the strength and deformation requirements of § 25.305.
- (2) A casting factor of greater than or equal to 1.25 but less than 1.50 may be used, provided that each casting receives:
- (i) Inspection of 100 percent of its surface, using visual and liquid penetrant, or equivalent, inspection methods; and
 - (ii) Inspection of structurally significant internal areas and areas where defects are likely to occur, using radiographic, or equivalent, inspection methods.
- (3) A casting factor of greater than or equal to 1.5 but less than 2.0 may be used, provided that each casting receives inspection of 100 percent of its surface using visual and liquid penetrant, or equivalent, inspection methods.
- (4) A casting factor of 2.0 or greater may be used, provided that each casting receives inspection of 100 percent of its surface using visual inspection methods.
- (5) The percentage of castings inspected by non-visual methods in accordance with subparagraphs (d)(2) and (d)(3) of this paragraph may be reduced when an approved quality control procedure is established.

INTERPRETATIVE MATERIAL

The following are acceptable means of compliance with ESF D-19.

ACJ 25.621

Casting Factors

General Guidance For Use of Casting Factors and Background to the Requirement

See JAR 25.621

1. Purpose.

2. General Guidance For Use Of Casting Factors.

2.1 For the analysis or testing required by § 25.307, the ultimate load level must include limit load multiplied by the required factor required by § 25.619. The testing required in accordance with § 25.621 may be used in showing compliance with § 25.305 and § 25.307. These factors need not be considered in the fatigue and damage tolerance evaluations required by § 25.571.

2.2 The inspection methods prescribed by § 25.621(c) and (d) for all production castings must be such that 100% of the castings are inspected by visual and liquid penetrant techniques, with total coverage of the surface of the casting. With regard to the required radiographic inspection, each production casting must be inspected by this technique or equivalent inspection methods; the inspection may be limited to the structurally significant internal areas and areas where defects are likely to occur.

2.3 With the establishment of consistent production, it is possible to reduce the inspection frequency of the non-visual inspections required by the rule for non-critical castings, with the approval of the Authority. This is usually accomplished by an approved quality control procedure incorporating a sampling plan. [Refer to § 25.621(d)(5)]

2.4 The static test specimen(s) should be selected on the basis of the foundry quality control inspections, in conjunction with those inspections prescribed in § 25.621(c) and (d). An attempt should be made to select the worst casting(s) from the first batch produced to the production standard.

2.5 If applicable, the effects on material properties due to weld rework should be addressed.

3. Background.

3.1 Regulatory Background.

3.1.1 Paragraph 25.621 (“Casting factors”) requires classification of structural castings as either “critical” or “non-critical.” Depending on classification, the requirement specifies the accomplishment of certain inspections and tests, and the application of special factors of safety for ultimate strength and deformation.

3.2 *Application of Special Factors of Safety.* The application of factors of safety applied to castings is based on the fact that the casting process can be inconsistent. Casting is a method of forming an object by pouring molten metal into a mould, allowing the material to solidify inside the mould, and removing it when solidification is complete. Castings are subject to variability in mechanical properties due to this casting process, which can result in imperfections, such as voids, within the cast part. Using certain inspection techniques, for example radiographic (X-ray), it is possible to detect such imperfections above a minimum detectable size, but accurate detection depends on the dimensions of the part, the inspection equipment used, and the skill of the inspector.

3.2.1 Paragraph 25.619 (“Special factors”) includes a requirement to apply a special factor to the factor of safety prescribed in § 25.303 for each part of the aeroplane structure whose strength is subject to appreciable variability because of uncertainties in the manufacturing processes or inspection methods. Since the mechanical properties of a casting depend on the casting design, the design values established under § 25.613 (“Material strength properties and design values”) for one casting might not be applicable to another casting made to the same specification. Thus, casting factors have been necessary for castings produced by normal techniques and methodologies to ensure the structural integrity of castings in light of these uncertainties.

3.2.2 Another approach is to reduce the uncertainties in the casting manufacturing process by use of a “premium casting process” (discussed in ACJ 25.621(c)(1)), which provides a means of using a casting factor of 1.0. Paragraph 25.621 (“Casting factors”) does permit the use of a casting factor of 1.0 for critical castings, provided that:

- the manufacturer has established tight controls for the casting process, inspection, and testing; and
- the material strength properties of the casting have no more variability than equivalent wrought alloys.

ACJ 25.621(c)(1)

Premium Castings

(Acceptable Means of Compliance)

See JAR 25.621

1. Purpose. This ACJ details an acceptable means, but not the only means, for compliance with § 25.621 for using a casting factor greater than or equal to 1.0, but less than 1.25, for “critical” castings used in structural applications. A premium casting process is capable of producing castings with predictable properties, thus allowing a casting factor of 1.00 to be used for these components.

Three major steps, required by § 25.621(c)(1)(i), are essential in characterising a premium casting process:

- qualification of the process,

- proof of the product, and
- monitoring of the process.

2. Definitions. For the purposes of this ACJ, the following definitions apply:

2.1 Premium Casting Process: a casting process that produces castings characterised by a high quality and reliability

2.2 Prolongation: an integrally cast test bar or test coupon.

2.3 Standard Test Casting: A casting produced specifically for the purpose of qualifying the casting process.

3. General. The objective of a premium casting process is to consistently produce castings with high quality and reliability. To this end, the casting process is one that is capable of consistently producing castings that include the following characteristics:

- Good dimensional tolerance
- Minimal distortion
- Good surface finish
- No cracks
- No cold shuts
- No laps
- Minimal shrinkage cavities
- No harmful entrapped oxide films
- Minimal porosity
- A high level of metallurgical cleanliness
- Good microstructural characteristics
- Minimal residual internal stress
- Consistent mechanical properties

The majority of these characteristics can be detected, evaluated, and quantified by standard non-destructive testing methods, or from destructive methods on prolongation or casting cut-up tests. However, a number of them cannot. Thus, to ensure an acceptable quality of product, the significant and critical process variables must be identified and adequately controlled.

4. A Means of Qualification of Casting Process.

4.1 To prove a premium casting process, the applicant should submit it to a qualification program that is specific to a foundry/material combination. The qualification program should establish the following:

- (a) The capability of the casting process of producing a consistent quality of product for the specific material grade selected for the intended production component.
- (b) The mechanical properties for the material produced by the process have population coefficients of variation equivalent to that of wrought products of similar composition (i.e., plate, extrusions, and bar). Usage of the population coefficient of variation from forged products does not apply.
- (c) The casting process is capable of producing a casting with uniform properties throughout the casting or, if not uniform, with a distribution of material properties that can be predicted to an acceptable level of accuracy.
- (d) The (initial) material design data for the specified material are established.
- (e) The material and process specifications are clearly defined.

4.2 For each material specification, a series of standard test castings from a number of melts, using the appropriate production procedures of the foundry, should be manufactured. The standard test casting produced should undergo a standardised inspection or investigation of non-destructive inspection and cut-up testing, to determine the consistency of the casting process.

4.3 The standard test casting should be representative of the intended cast product(s), and should expose any limitations of the casting process. In addition, the standard test casting should be large enough to provide mechanical test specimens from various areas, for tensile and, if applicable, compression, shear, bearing, fatigue, fracture toughness, and crack propagation tests. If the production component complies with these requirements, it may be used to qualify the process. The number of melts sampled should be statistically significant. Typically, at least 10 melts are sampled, with no more than 10 castings produced from each melt. If the material specification requires the components to be heat-treated, this should be done in no fewer than 10 heat treatment batches consisting of castings from more than one melt. Reduction of qualification tests may be considered if the casting process and the casting alloy is already well known for aerospace applications and the relevant data are available.

4.4 Each standard test casting should receive:

- inspection of 100% of its surface, using visual and liquid penetrant, or equivalent, inspection methods; and
- inspection of structurally significant internal areas and areas where defects are likely to occur, using radiographic methods or equivalent inspection methods. The specific radiographic standard to be employed is to be determined, and the margin by which the standard test castings exceed the minimum required standard should be recorded.
 - (a) The program of inspection is intended to confirm the consistency of the casting process, as well as to ensure the stated objectives on surface finish, cracks, cold shuts, laps, shrinkage cavities, and porosity.
 - (b) In addition, the program of inspection is to ensure that the areas from which the mechanical property samples were taken were typical of the casting as a whole with respect to porosity and cleanness.

4.5 All standard test castings should be cut up to a standardised methodology to produce the mechanical test specimens detailed above. Principally, the tests are to establish the variability within the cast component, as well as to determine the variability between components from the same melt and from melt to melt. The data gathered also may be used during latter phases to identify deviations from the limits established in the process qualification and product proving programs.

4.6 All the fracture surfaces generated during the qualification program should be inspected at least visually for detrimental defects.

4.7 As part of the cut-up investigation, it is usually necessary to take metallographic samples for cleanness determination and microstructural characterisation.

4.9 When the process has been qualified, it should not be altered without completing comparability studies and necessary testing of differences.

5. Proof of Product

5.1 Subsequent to the qualification of the process, the production castings should be subjected to a production-proving program. Such castings should have at least one prolongation; however, large and/or complex castings may require more than one. If a number of castings are produced from a single mould with a single runner system, they may be treated as one single casting. The production proving program should establish the following:

- (a) The design values developed during the process qualification program are valid (e.g., same statistical distribution) for the production casting.
- (b) The production castings have the same or less than the level of internal defects as the standard test castings produced during qualification.
- (c) The cast components have a predictable distribution of tensile properties.
- (d) The prolongation(s) is representative of the critical area(s) of the casting.

- (e) The prolongation(s) consistently reflects the quality process, and material properties of the casting.

5.2 A number of (i.e., at least two) pre-production castings of each part number to be produced should be selected for testing and inspection. All of the selected castings should be non-destructively inspected in accordance with the qualification program.

- (a) One of these castings should be used as a dimensional tolerance test article. The other selected casting(s) should be cut up for mechanical property testing and metallographic inspection.
- (b) The casting(s) should be cut up to a standardised program to yield a number of tensile test specimens and metallographic samples. There should be sufficient cut-up tensile specimens to cover all critical (“critical” with respect to both the casting process and service loading) areas of the casting.
- (c) All prolongations should be machined to give tensile specimens, and subsequently tested.
- (d) The production castings should be produced to production procedures identical to those used for these pre-production castings.

5.3 On initial production, a number of castings should undergo a cut-up for mechanical property testing and metallographic inspection, similar to that performed for the pre-production casting(s). The cut-up procedure used should be standardised, although it may differ from that used for the preproduction casting(s). Tensile specimens should be obtained from the most critical areas.

- (a) For the first 30 castings produced, at least 1 casting in 10 should undergo this testing program.
- (b) The results from the mechanical property tests should be compared with the results obtained from the prolongations to further substantiate the correlation between prolongation(s) and the critical area(s) of the casting.
- (c) In addition, if the distribution of mechanical properties derived from these tests is acceptable, when compared to the property values determined in the qualification program, the frequency of testing may be reduced. However, if the comparison is found not to be acceptable, the test program may require extension.

5.4 At no point in the production should the castings contain shrinkage cavities, cracks, cold shuts, laps, porosity, or entrapped oxide film, or have a poor surface finish, exceeding the acceptance level defined in the technical specifications.

6. Monitoring the Process.

6.1 The applicant should employ quality techniques to establish the significant/critical foundry process variables that have an impact on the quality of the product. The applicant should show that these variables are controlled with positive corrective action throughout production.

6.2 During production, every casting should be non-destructively inspected using the techniques and the acceptance standards employed during the qualification program.

- (a) Rejections should be investigated and process corrections made as necessary.
- (b) Alternative techniques may be employed if the equivalence in the acceptance levels can be demonstrated.
- (c) In addition, tensile tests should be taken from the prolongations on every component produced, and the results should comply with limits developed in the process qualification and product proving programs.
- (d) Additionally, as previously mentioned, a periodic casting cut-up inspection should be undertaken, with the inspection schedule as agreed upon during the proof of product program.
- (e) Deviations from the limits established in the process qualification and product proving programs should be investigated and corrective action taken.

7. Modifications to the Casting Design, Material, and Process.

7.1 Additional testing may be required when alterations are made to the casting geometry, material, significant/critical process variables, process, or production foundry to verify that the alterations have not significantly changed the castings' properties. The verification testing recommended is detailed in

Table 1, below:

<u>Modifications</u>					<u>Verification Testing</u>		
Case	Geometry	Material	Process	Foundry	Qualification of Process	Proof of Product	Tests per § 25.621(c)(1)
1	yes	none	none	none	not necessary	yes	yes (b)
2	none	yes	none	none	yes (a)	yes	yes (b)
3	yes	yes	none	none	yes	yes	yes
4	none	none	yes	none	yes (a)	yes	yes (b)
5	none	none	none	yes	yes (a)	yes	yes (b)
(a) The program described in paragraph 4. of this ACJ to qualify a new material, process, and foundry combination may not be necessary if the following 3 conditions exist for the new combination: <ol style="list-style-type: none"> (1) Sufficient data from relevant castings to show that the process is capable of producing a consistent quality of product, and that the quality is comparable to or better than the old combination. (2) Sufficient data from relevant castings to establish that the mechanical properties of the castings produced from the new combination have a similar or better statistical distribution than the old combination. (3) Clearly defined material and process specifications. 							
(b) The casting may be re-qualified by testing partial static test samples (with larger castings, re-qualification could be undertaken by a static test of the casting's critical region only); this should be approved.							

– END –

SPECIAL CONDITION and IM	D-20 SC & IM: Towbarless towing
APPLICABILITY:	A380
REQUIREMENTS:	JAR 25.745(d), INT/POL/25/13
ADVISORY MATERIAL:	N/A

BACKGROUND

JAR 25x745(d), at change 15, states that "*the design of the attachment for towing the aeroplane on the ground must be such as to preclude damage to the steering system*". This requirement originated at a time when the ground handling arrangements for aeroplanes typically included a towing attachment on the nose landing gear assembly, and was drafted in a form which took account of the towing methods in use at that time. The intent of this requirement was to ensure that aeroplanes are designed such that any means to be used for ground manoeuvring of the aeroplane with the knowledge and/or approval of the constructor should not have the capability to cause damage to the steering system.

The design of the nose landing gear incorporates means to preclude damage to the steering system in the event that loads induced in the steering system by conventional towbar towing activities approach the capability of the design to withstand the loads. Airbus Industrie are intending to give approval to other methods of towing the aeroplane, typically referred to as "Towbarless Towing", which utilise means which do not connect to the aeroplane nose landing gear via the protection device installed to ensure compliance with the Requirement.

Consequently, if "towbarless" towing devices are known to be used and/or have the approval of the constructor for ground manoeuvring of the aeroplane, some means must be provided within the design of the aeroplane that will give, at the very least, an equivalent level of protection to the steering system as that which is available from the more conventional towbar towing arrangements.

If, due to specific nose landing gear constraints, such means cannot be defined, or are considered not to be practicable, the constructor may define such alternative means in order to provide the flight crew with an unmistakable warning, prior to the start of taxiing, if damage to the steering system may have occurred during ground manoeuvring activities. Such means may be considered as providing equivalent safety to devices which preclude damage to the steering system.

The use of towbarless towing vehicles is unconventional and JAR 25 does not contain adequate safety standard for such operations.

In accordance with JAR 21.16(a)(2), the JAA team consider that a Special Condition and Interpretative Material, based on JAA INT/POL 25/13 issued on 1 June 2001, is needed to address towbarless towing operations.

SPECIAL CONDITION

Delete the entire text of the current paragraph JAR 25X745(d) and replace with the following:

JAR 25X745 Nose-Wheel Steering

- d) (see ACJ 25X745(d)) The nose-wheel steering system, towing attachment(s), and associated elements must be designed or protected by appropriate means such that during ground manoeuvring operations effected by means independent of the aeroplane:
- (1) Damage affecting the safe operation of the nose-wheel steering system is precluded, or
 - (2) A flight crew alert is provided, before the start of taxiing, if damage may have occurred. (see AMJ 25.1322)

INTERPRETATIVE MATERIAL

JAR ACJ 25X745(d) Nose-Wheel Steering

JAR25X745(d) observes two possibilities being:

- (d)(1): A "no damage" situation exists, because damage is precluded.
(d)(2): Damage can occur, but indication to the crew is provided.

1. General to (d)(1) and (d)(2) is the following:

Some damage may occur during ground manoeuvring activities that can be considered acceptable and judged to be normal wear and tear. It is not intended that such damage need necessarily be precluded or that it should initiate a crew alert.

2. To comply with (d)(1) the following applies:

The aeroplane may be designed such that under all ground manoeuvring operations by any towing means no damage affecting the steering system can occur.

Examples are:

- Steering System is designed sufficiently strong to resist any applied towing input.
- Steering system is designed to allow 360 degrees rotation.
- Steering System is disconnected either automatic or by operations procedure.
- Steering system is protected by shear sections installed on the nose landing gear.

3. To comply with (d)(2) the following applies:

When protection is afforded by the crew alerting system, the damage detection means should be independent of the availability of aeroplane power supplies and should be active during ground manoeuvring operations effected by means independent of the aeroplane. If damage may have occurred, a latched signal should be provided to the crew alerting system.

4. Alternative Acceptable Means of Compliance to (d)(1) and (d)(2):

In the case that the aeroplane design does not comply with (d)(1) and (d)(2) the following applies:

- (a) The Aeroplane Flight Manual in the Section Limitations should include a statement that "Towbarless Towing is prohibited", or
- (b) The Aeroplane Flight Manual in the Section Limitations should include a statement that: "Towbarless Towing is prohibited, unless the towbarless towing operations are performed in compliance with the appropriate operational requirements (JAR-OPS-1 for Commercial Air Transportation) using towbarless towing vehicles that are designed and operated to preclude damage to the aeroplane nose wheel steering system, or which provide a reliable

and unmistakable warning when damage to the steering system may have occurred. Towbarless towing vehicles that are specifically accepted for this type of aeroplane must be listed in the documentation provided by the aeroplane manufacturer.”

- (c) The acceptance by the aeroplane manufacturer of the applicable towbarless towing vehicles and its reliability of the oversteer protection and/or indication system as referred to in (b) should be based on the following:
1. The aeroplane Nose Wheel Steering Failure Analyses should include the effects of possible damage caused by towbarless towing operations.
 2. If the Nose Wheel Steering Failure Analyses shows that damage to the steering system by the use of towbarless towing may result in a Failure Condition that can be classified as Hazardous or Catastrophic (ref. JAR25.1309), the acceptance of a towing vehicle oversteer protection and/or indication system should be based on an aeroplane safety analysis, encompassing the reliability of that vehicle system, in order to meet the aeroplane safety objectives.
 3. If the Nose Wheel Steering Failure Analyses shows that damage to the steering system by the use of towbarless towing may result in a Failure Condition that can be classified as Major or less severe, the aeroplane manufacturer can accept the design of the towing vehicle oversteer indication- and/or protection system based on a “Declaration of Compliance”, issued by the towbarless towing vehicle manufacturer. That declaration will state that the vehicle design complies with the applicable standards (SAE ARP’s, Aeroplane Towing Assessment Criteria Document) and that it is designed and built under ISO 9001 quality standards or equivalent.
Such a Declaration must be made regarding all Towbarless Towing Vehicles to be used for ground manoeuvring of JAR25 certified aeroplanes.

– END –

EQUIVALENT SAFETY FINDING	D-21 ESF: Allowable Carbon Dioxide concentration in aeroplane cabins & Cabin Ozone concentration
APPLICABILITY:	A380
REQUIREMENTS:	JAR 25.831(b)(2), JAR 25.832
ADVISORY MATERIAL:	N/A

BACKGROUND

Airbus has proposed to use NPA 25D-285. Technical conditions introduced via NPA 25D-285 are clearly more severe than existing ones in JAR 25 at change 15. In particular, the requirement for a maximum permissible Ozone concentration does not currently exist in JAR25. Therefore JAA accept Airbus proposal to apply NPA 25D-285, as equivalent safety finding in addition to mandatory applicable technical requirements.

The equivalent safety finding introduced by NPA 25D-285 is provided.

CONCLUSION

NPA 25D-285 JAR-25 Large Aeroplanes

1. **Title ALLOWABLE CARBON DIOXIDE CONCENTRATION IN AERO-PLANE CABINS & CABIN OZONE CONCENTRATION**
2. **Sponsor** REGULATION DIVISION, JAA HQ
3. **Introduction**

In 1990 the FAA published NPRM 90-14, proposing to amend paragraph FAR Part 25.831(b)(2). Although the texts were, at that time harmonised, the NPRM was not included as part of the JAA/FAA Harmonisation Work Programme developed in 1992. Nevertheless, the JAA's D & F S.G. reviewed the NPRM and subsequently sent supporting comments to the FAA.

The Final Rule, now published, has introduced a difference between JAR-25 and FAR Part 25. This NPA proposes the adoption of the FAA text, so as to restore Harmonisation. Although not included in the FAA's NPRM or Final Rule, this NPA also proposes the introduction, into JAR-25, of the text of FAR Part 25.832 – Ozone Concentration. The topic is related to that in JAR 25.831, as both fall under the heading of "Ventilation and Heating" in JAR 25, Subpart D. The adoption of the proposed JAR 25.832 will remove a long standing, existing difference between JAR-25 and FAR Part 25 because of the JAA's stated commitment to adopt the FAA text into JAR-25.

4. Proposals

4.1. Amend JAR 25.831(b)(2) to read as follows:

(b)

(2) Carbon dioxide concentration during flight must be shown not to exceed 0.5 % by volume (sea level equivalent) in compartments normally occupied by passengers or crew members. For the purpose of this sub-paragraph, "sea level equivalent" refers to conditions of 25° C (77° F) and 760 millimetres of mercury pressure (1013.2 hPa). Based on this definition the maximum measured concentration, sea level equivalent, for a cabin altitude of 8000 feet would be 0.5 % divided by 0.74 (the ratio of air pressure at 8000 ft to air pressure at sea level), or 0.68 %.

4.2. Delete the existing note in JAR 25.832, and add a new JAR 25.832 as follows:

JAR 25.832 Cabin ozone concentration.

- (a) The aeroplane cabin ozone concentration during flight must be shown not to exceed-
 - (1) 0.25 parts per million by volume, sea level equivalent, at any time above flight level 320; and
 - (2) 0.1 parts per million by volume, sea level equivalent, time-weighted average during any 3-hour interval above flight level 270.
- (b) For the purpose of this paragraph, "sea level equivalent" refers to conditions of 25° C (77° F) and 760 millimetres of mercury pressure (1013.2 hPa).
- (c) Compliance with this paragraph must be shown by analysis or tests based on aeroplane operational procedures and performance limitations, that demonstrate that either:
 - (1) The aeroplane cannot be operated at an altitude which would result in cabin ozone concentrations exceeding the limits prescribed by sub-paragraph (a) of this paragraph; or
 - (2) The aeroplane ventilation system, including any ozone control equipment, will maintain cabin ozone concentrations at or below the limits prescribed by sub-paragraph (a) of this paragraph.

– END –

EQUIVALENT SAFETY FINDING	D-24 ESF: Packs off operation
APPLICABILITY:	A380
REQUIREMENTS:	JAR 25.831(a)
ADVISORY MATERIAL:	N/A

BACKGROUND

JAR 25.831(a) states :

Each passenger and crew compartment must be ventilated and each crew compartment must have enough fresh air (but not less than 10 cubic feet per minute per crew member) to enable crew members to perform their duties without undue discomfort or fatigue.(See ACJ 25.831(a)).

Taking into consideration that there are some air-conditioning packs off operation periods (i.e., at take-off, no fresh air for crew members) for the Model A380, direct compliance to JAR 25.831(a) is not possible.

In accordance with JAR 21.21(c)(2), an equivalent safety finding may be used for showing compliance to JAR 25.831(a) provided the following is considered:

CONCLUSION

1. There must be a means to annunciate to the flight crew that the pressurisation system (conditioned air supply) is selected off.
2. It must be demonstrated that the ventilation system continues to provide an acceptable environment in the passenger cabin and cockpit for the brief period when the pressurisation system is not operating. The degradation of crewmember air quality must not reach the level that would cause undue discomfort and fatigue to the point that it could affect the performance of their duties.
3. Furthermore, equipment environment shall be evaluated during those short periods to ensure equipment reliability and performance are not impaired. This evaluation should cover the extremes of ambient hot air temperatures in which the aeroplane is expected to operate.
4. In addition, it must be demonstrated that no unsafe condition due to limited packs-off operation would result, should a fire occur. Criteria that should be considered include:
 - (a) Cockpit Smoke Penetration and Evacuation regarding any cargo or electronic compartment fire and Cabin Smoke Penetration regarding cargo compartment fire shall not be impaired by packs off operation.
Furthermore, Item 2.1 of special condition D-7 regarding smoke and fire propagation between the two decks shall also be considered for packs off operation.
Smoke penetration from the cargo compartments into the cockpit and cabin will be covered by compliance to JAR 25.857 (c) and JAR 25.858.
 - (b) During limited duration packs-off operation the smoke detection systems are effective and the AC packs can be turned on and returned to the approved packs-on configuration to exclude hazardous quantities of smoke.
5. Finally, the air conditioning packs-off operation is intended to be a short duration operation. Therefore, the maximum period of operation in this configuration should be defined by the

applicant and specified in the AFM, along with any related operating procedures necessary to maintain compliance with the regulatory issues discussed above.

An example of establishing “the maximum period of operation (short duration) for take-off”, would be an operational phase beginning with turning packs off when cleared into position for take-off, and ending when packs were turned back on after take-off thrust was reduced to climb thrust or when accomplishing the “after take-off” check list.

– END –

SPECIAL CONDITION and IM	D-28 SC & IM: Harmonised 671/672
APPLICABILITY:	A380
REQUIREMENTS:	JAR 25.671, 25.672
ADVISORY MATERIAL:	ACJ 25.671 and 25.672

BACKGROUND

JAR 25.671 ensures the basic integrity and availability of flight control systems, and further ensures that any failure experienced in service is manageable by the aircrew and will not prevent continued safe flight and landing.

JAR 25.672 ensures the basic integrity and availability of augmentation & power operated systems, and further ensures that any failure experienced in service is manageable by the aircrew and will not prevent continued safe flight and landing. This requirement also contains the idea of transition to a limited flight envelope following a system failure.

The A380 is equipped with a complex and sophisticated electronic flight control system which provides neutral stability and flight envelope protection features. A special condition has been developed to address concerns or features which were not adequately covered by existing requirements.

An ARAC Working Group has worked on a new proposal for paragraphs 25.671 and 25.672 and associated advisory material, prompted by efforts to harmonize the requirements, recommendations from the NTSB as a result of accident investigation, and the need to update the rule to address recent Special Conditions applied to fly-by-wire control systems.

The JAA believes that the latest evolutions of JAR 25.671 and 25.672 and associated ACJ, as proposed by ARAC are not mature enough to be used as a whole on the A380 certification.

For A380 Type Certification, the special condition SC D-28 and interpretative material IM D-28, based on extracts of the ARAC proposal for 25.671 and 25.672 are proposed by JAA Team. Clarification on Flight Control Jamming is also introduced in Interpretative Material IM D-28.

SPECIAL CONDITION

In addition to current JAR 25.671 paragraph, the following conditions are applicable:

1. The flight control system shall be designed to continue to operate and must not hinder aircraft recovery from any attitude.
2. The system design must ensure that the flight crew is made suitably aware whenever the primary control means nears the limit of control authority.
3. If the design of the flight control system has multiple modes of operation, a means must be provided to indicate to the crew any mode that significantly changes or degrades the normal handling or operational characteristics of the aeroplane.

INTERPRETATIVE MATERIAL

a. Definition :

Jam. A failure or event such that a control surface, pilot control, or component is fixed in one position.

- (i) If the control surface or pilot control is fixed in position due to a physical interference, it is addressed under JAR 25.671(c)(3). Causes may include corroded bearings, interference with a foreign or loose object, control system icing, seizure of an actuator, or a disconnect that results in a jam by creating an interference. Jams of this type must be assumed to occur and should be evaluated at positions up to and including the normally encountered positions defined below.
 - (ii) All other failures that result in a fixed control surface, pilot control, or component are addressed under JAR 25.671(c)(1) and 25.671(c)(2), as appropriate. Depending on system architecture and the location of the failure, some jam failures may not always result in a fixed surface or pilot control; for example, a jammed valve could result in a surface runaway.
- b. Determination of Control System Jam Positions – JAR 25.671(c)(3). The flight phases required by JAR 25.671 can be encompassed by three flight phases: take-off, in-flight (climb, cruise, normal turns, descent, and approach), and landing.

Take-off is considered to be the time period between brake release and 35 ft. In-flight is considered to be from 35 ft following a take-off to 50 ft. prior to landing including climb, cruise, normal turns, descent, and approach.

JAR 25.671(c)(3) requires that the aeroplane be capable of landing with a flight control jam and that the aeroplane be evaluated for jams in the landing configuration. However, for the evaluation of jams which occur just prior to landing, proximity to the ground need not be considered for the transient condition. Given that some amount of time and altitude is necessary in order to recover from any significant flight control jam, there is no practical means by which such a recovery could be demonstrated all the way to touchdown. The potential delay in accomplishing a recovery could be on the order of 5 seconds. For a jam at a control deflection corresponding to 0.8 g, a recovery may not be possible below approximately 200' even with a state of the art control system. While it is recognised that this means that a specific hazard is not addressed (a control jam that occurs, or is recognised, just before landing), this hazard is mitigated for the following reasons. First, the landing phase represents a limited exposure window in which a jam could occur. Second, successful operation of the controls throughout the flight minimises the likelihood of a jam suddenly appearing during the landing phase. Also, some sources of jamming such as icing are not prevalent in the landing phase.

Third, a certain level of recovery capability will be ensured through compliance with this interpretative material such that if a jam does occur during landing, the crew will have a reasonable chance of landing safely.

Only the aeroplane rigid body modes need to be considered when evaluating the aircraft response to manoeuvres and continued safe flight to landing.

It is assumed that if the jam is detected prior to V₁, the take-off will be rejected.

Although 1 in 1000 operational take-offs is expected to include crosswinds up to 25 knots, the short exposure time associated with a control surface jam occurring between V₁ and V_{LOF} allows usage of a less conservative crosswind magnitude when determining normally encountered lateral and directional control positions. Given that lateral and directional controls are continuously used to maintain runway centreline in a crosswind take-off, and control inputs greater than that necessary at V₁ will occur at speeds below V₁, any jam in these control axes during a crosswind take-off will normally be detected prior to V₁. Considering the control jam failure rate of approximately 10⁻⁶ to 10⁻⁷ per flight hour combined with the short exposure time between V₁ and V_{LOF}, a reasonable crosswind level for determination of jammed lateral or directional control positions during take-off is 15 knots.

The jam positions to be considered in showing compliance include any position up to the maximum position determined by the following manoeuvres. The manoeuvres and conditions described here are only to provide the control surface deflection to evaluate continued safe

flight and landing capability, and are not to represent flight test manoeuvres for such an evaluation.

(1) Jammed Lateral Control Positions.

- (i) Take-off: The lateral control position for wings-level at V_1 in a steady crosswind of 15 knots (at a height of 10 meters above the takeoff surface). Variations in wind speed from a 10 meter height can be obtained using the following relationship:

$$V_{alt} = V_{10\text{meters}} * (H_{desired}/10.0)^{1/7}$$

Where:

- $V_{10\text{meters}}$ = Wind speed at 10 meters AGL (knots) V_{alt}
= Wind speed at desired altitude (knots) $H_{desired}$ = Desired altitude for which wind speed is sought (Meters AGL), but not lower than 1.5m (5 ft)

- (iii) In-flight: The lateral control position to sustain a 12 deg/sec steady roll rate from $1.23V_{SR1}(1.3V_S)$ to V_{MO}/M_{MO} or V_{fe} , as appropriate, but not greater than 50% of the control input.

Note: If the flight control system augments the pilot's input, then the maximum surface deflection to achieve the above manoeuvres should be considered.

(2) Jammed Longitudinal Control Positions.

- (i) Take-off: Three longitudinal control positions should be considered:

- (1) Any control position from that which the controls naturally assume without pilot input at the start of the take-off roll to that which occurs at V_1 using the manufacturer's recommended procedures.

Note: It may not be necessary to consider this case if it can be demonstrated that the pilot is aware of the jam before reaching V_1 (for example, through a manufacturer's recommended AFM procedure).

- (2) The longitudinal control position at V_1 based on the manufacturers recommended procedures including consideration for any runway condition for which the aircraft is approved to operate.

- (3) Using the manufacturers recommended procedures, the peak longitudinal control position to achieve a steady aircraft pitch rate of the lesser of 5 deg/sec or the pitch rate necessary to achieve the speed used for all-engines operating initial climb procedures (V_{2+XX}) at 35 ft.

- (ii) In-flight: The maximum longitudinal control position is the greater of :

- (1) The longitudinal control position required to achieve steady state normal accelerations from 0.8g to 1.3g at speeds from $1.23V_{SR1}(1.3V_S)$ to V_{MO}/M_{MO} or V_{fe} , as appropriate.

- (2) The peak longitudinal control position commanded by the autopilot and/or stability augmentation system in response to atmospheric discrete vertical gust defined by 15 fps from sea level to 20,000 ft.

(3) Jammed Directional Control Positions.

- (i) Take-off: The directional control position for take-off at V_1 in a steady crosswind of 15 knots (at a height of 10 meters above the take-off surface). Variations in wind speed from a height of 10 meters can be obtained using the following relationship:

$$V_{alt} = V_{10\text{meters}} * (H_{desired}/10.0)^{1/7}$$

Where:

- $V_{10\text{meters}}$ = Wind speed at 10 meters AGL (knots) V_{alt}

= Wind speed at desired altitude (knots) H_{desired}
 = Desired altitude for which wind speed is sought (Meters AGL), but not lower than 1.5m (5 ft)

(ii) In-flight: The directional control position is the greater of:

- (1) The peak directional control position commanded by the autopilot and/or stability augmentation system in response to atmospheric discrete lateral gust defined by 15 fps from sea level to 20,000 ft.
- (2) Maximum rudder angle required for lateral/directional trim from $1.23V_{SR1}(1.3V_S)$ to the maximum all engines operating airspeed in level flight with climb power, but not to exceed V_{MO}/M_{MO} or V_{fe} as appropriate.
 While more commonly a characteristic of propeller aircraft, this addresses any lateral/directional asymmetry that can occur in flight with symmetric power.

(4) Control Tabs, Trim Tabs, and Trimming Stabilisers.

Any tabs installed on control surfaces are assumed jammed in the position associated with the normal deflection of the control surface on which they are installed.

Trim tabs and trimming stabilisers are assumed jammed in the positions associated with the manufacturer's recommended procedures for take-off and that are normally used throughout the flight to trim the aircraft from $1.23V_{SR1}(1.3V_S)$ to V_{MO}/M_{MO} or V_{fe} , as appropriate.

(5) Speed Brakes. Speed brakes are assumed jammed in any position for which they are approved to operate during flight at any speed from $1.23V_{SR1}(1.3V_S)$ to V_{MO}/M_{MO} or V_{fe} , as appropriate. Asymmetric extension and retraction of the speed brakes should be considered. Roll spoiler jamming (asymmetric spoiler panel) is addressed under paragraph (1).

(6) High Lift Devices. Leading edge and trailing edge high lift devices are assumed to jam in any position for take-off, climb, cruise, approach, and landing. Skew of high lift devices or asymmetric extension and retraction should be considered; JAR 25.701 contains a requirement for flap mechanical interconnection unless the aircraft has safe flight characteristics with the asymmetric flap positions not shown to be extremely improbable.

(7) Load Alleviation Systems.

(i) Gust Load Alleviation Systems. At any airspeed between $1.23V_{SR1}(1.3V_S)$ to V_{MO}/M_{MO} or V_{fe} , as appropriate, the control surfaces are assumed to jam in the maximum position commanded by the gust load alleviation system in response to a discrete atmospheric gust with the following reference velocities:

- (1) 15 fps (EAS) from sea level to 20,000 ft (vertical gust),
- (2) 15 fps (EAS) from sea level to 20,000 ft (lateral gust).

(8) Manoeuvre Load Alleviation Systems. At any airspeed between $1.23V_{SR1}(1.3V_{Smin})/V_{ref}$ to $V_{MO}/M_{MO}/V_{fe}$ the control surfaces are assumed to jam in the maximum position commanded by the manoeuvre load alleviation system during a pull-up manoeuvre to 1.3g or a pushover manoeuvre to 0.8g.

c. Compliance to SC D-28 (1) Abnormal attitude.

Compliance should be shown by evaluation of the closed loop flight control system. This evaluation is intended to ensure that there are no features or unique characteristics (including numerical singularities) which would restrict the pilot's ability to recover from any attitude. It is

not the intent of this rule or guidance material to limit the use of envelope protection features or other systems that augment the control characteristics of the aircraft.

d. Compliance to SC D-28 (2) Limit of control authority

SC D-28 requires suitable annunciation to be provided to the flight crew when a flight condition exists in which near-full control authority (not pilot-commanded) is being used.

Suitability of such a display must take into account that some pilot-demanded manoeuvres (e.g., rapid roll) are necessarily associated with intended full performance, which may saturate the surface. Therefore, simple alerting systems, which would function in both intended and unexpected control-limiting situations, must be properly balanced between needed crew awareness and nuisance alerting. Nuisance alerting should be minimised. The term suitable indicates an appropriate balance between nuisance and necessary operation.

Depending on the application, suitable annunciations may include cockpit control position, annunciator light, or surface position indicators. Furthermore, this requirement applies at limits of control authority, not necessarily at limits of any individual surface travel.

e. Compliance to SC D-28 (3) Submodes of operation

Some systems, EFCS in particular, may have submodes of operation not restricted to being either on or off. The means provided to the crew to indicate the current submode of operation may be different from the classic “failure warning.”

– END –

SPECIAL CONDITION	D-31 SC: High altitude operation
APPLICABILITY:	A380
REQUIREMENTS:	JAR 25.831, 25.841
ADVISORY MATERIAL:	N/A

BACKGROUND

The maximum operating altitude of A380 is 43.000 ft.

JAR 25 standards, related to cabin ventilation and pressurisation, have been developed at a time when flights above 41 000 ft. were not envisaged. Those requirements are not appropriate for flights above 41 000 ft. and there is a need to ensure that survivable conditions are maintained in the cabin in the event of a decompression or of a malfunction of the pressurisation/air conditioning system.

Therefore there is a need to define a special condition.

SPECIAL CONDITION

A - PRESSURE VESSEL INTEGRITY

For the damage tolerance evaluation, in addition to the damage sizes critical for residual strength, the damage sizes critical for depressurisation decay must be considered, taking also into account the (normal) unflawed pressurised cabin leakage rate. The resulting leakage rate must not result in the cabin altitude exceeding the cabin altitude time history shown in Figure 4.

B - VENTILATION

In lieu of the requirements of JAR 25.831(a), the ventilation system must be designed to provide a sufficient amount of uncontaminated air to enable the crew members to perform their duties without undue discomfort and fatigue and to provide reasonable passenger comfort during normal operating conditions and also in the event of any probable failure of any system which could adversely affect the cabin ventilating air. For normal operations, crew members and passengers must be provided with at least 0.55 lb/min of fresh air per person or the equivalent in filtered, recirculated air based on the volume and composition at the corresponding cabin pressure altitude of not more than 8 000 ft.

The supply of fresh air in the event of the loss of one source, should not be less than 0.4 lb/min per person for any period exceeding five minutes. However, reductions below this flow rate may be accepted provided that the compartment environment can be maintained at a level which is not hazardous to the occupant (text of the ACJ 25.831(a) of JAR-25 change 15).

C - AIR CONDITIONING

In addition to the requirements of JAR 25.831, paragraphs (b) through (e), the cabin cooling system must be designed to meet the following conditions during flight above 15 000 ft. mean sea level (MSL):

1. After any probable failure, the cabin temperature-time history may not exceed the values shown in Figure 1.
2. After any improbable failure, the cabin temperature-time history may not exceed the values shown in Figure 2.

Other temperatures standards could be accepted by the JAA if they provide an equivalent level of safety.

D - PRESSURISATION

In addition to the requirements of JAR 25.841, the following apply:

1. The pressurisation system, which includes for this purpose bleed air, air conditioning and pressure control systems, must prevent the cabin altitude from exceeding the cabin altitude-time history shown in Figure 3 after each of the following :
 - a) Any probable double failure in the pressurisation system (JAR 25.1309 may be applied).
 - b) Any single failure in the pressurisation system combined with the occurrence of a leak produced by a complete loss of a door seal element, or a fuselage leak through an opening having an effective area 2.0 times the effective area which produces the maximum permissible fuselage leak rate approved for normal operation, whichever produces a more severe leak.
2. The cabin altitude-time history may not exceed that shown in Figure 4 after each of the following :
 - a) The pressure vessel opening or duct failure resulting from probable damage (failure effect) while under maximum operating cabin pressure differential due to a tyre burst, loss of antennas or stall warning vanes, or any probable equipment failure (bleed air, pressure control, air conditioning, electrical source(s) ...) that affects pressurisation.
 - b) Complete loss of thrust from engines.
3. In showing compliance with paragraph D.1 and D.2 of this special condition, it may be assumed that an emergency descent is made by an approved emergency procedure. A 17-seconds crew recognition and reaction time must be applied between cabin altitude warning and the initiation of emergency descent.
For flight evaluation of the rapid descent, the test article must have the cabin volume representative of what is expected to be normal.
4. Engine rotor failures must be assessed according to the requirements of JAR 25.903(d)(1). In considering paragraph 8.d(2) of AMJ 20-128A, consideration must be given to the practicability and feasibility of minimising the depressurisation effects, assessing each aircraft configuration on a case-by-case basis, and taking into account the practices in the industry for each configuration.

E - OXYGEN EQUIPMENT AND SUPPLY

1. A continuous flow oxygen system must be provided for the passengers.
2. A quick-donning pressure demand mask with mask-mounted regulator must be provided for each pilot. Quick-donning from the stowed position must be demonstrated to show that the mask can be withdrawn from the stowage and donned within 5 seconds.

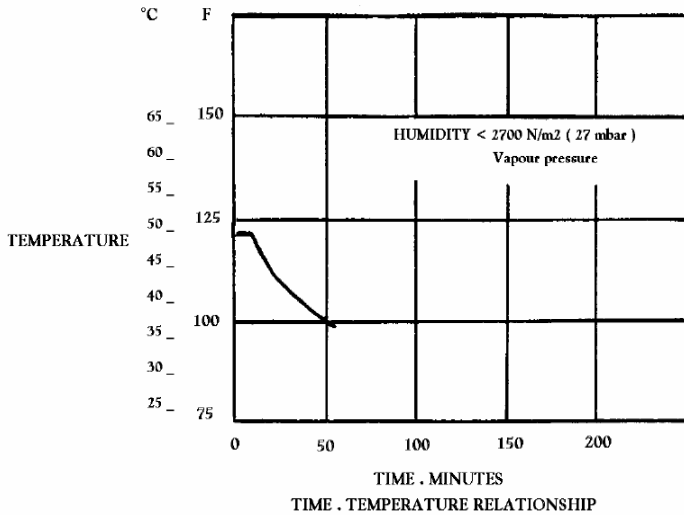

Figure 1

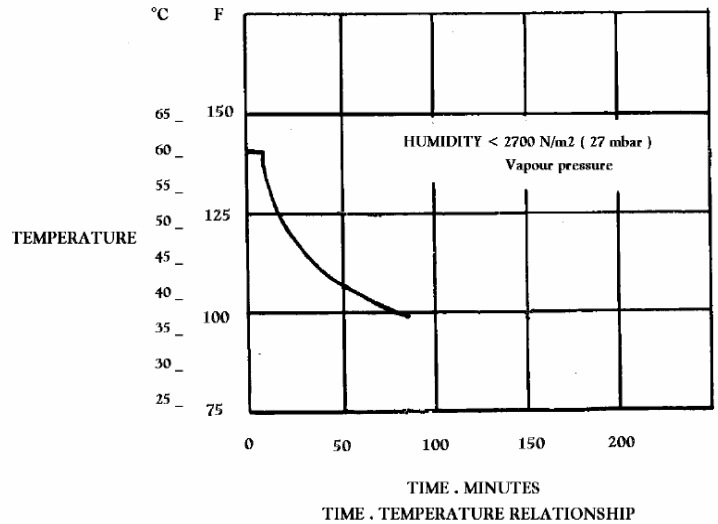
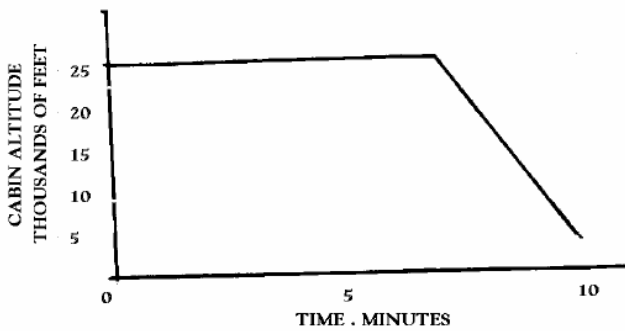

Figure 2

Figure 3

CABIN ALTITUDE . TIME HISTORY
(Supplemental oxygene available to all passengers)



For Figure 3, time starts at the moment cabin altitude exceeds 8000 ft during depressurization.

If depressurization analysis shows that the cabin altitude limit of this curve is exceeded, the following alternate limitations apply : after depressurization, the maximum cabin altitude exceedance is limited to 30.000 ft. The maximum time the cabin altitude may exceed 25.000 ft is two minutes; time starting when the cabin altitude exceeds 25.000 ft and ending when it returns to 25.000 ft.

Figure 4

CABIN ALTITUDE . TIME HISTORY
(Supplemental oxygene available to all passengers)

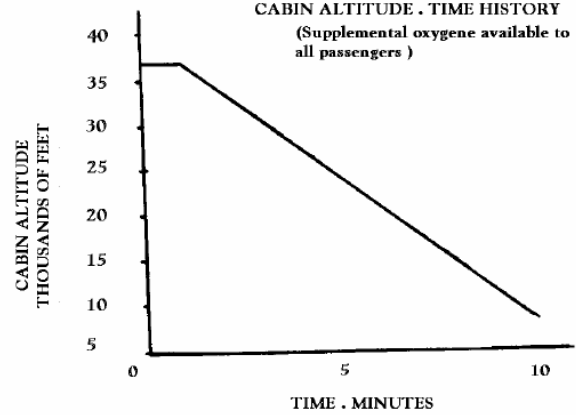

For Figure 4, time starts at the moment cabin altitude exceeds 8000 ft during depressurization.

If depressurization analysis shows that the cabin altitude limit of this curve is exceeded, the following alternate limitations apply : after depressurization, the maximum cabin altitude exceedance is limited to 40.000 ft. The maximum time the cabin altitude may exceed 25.000 ft is two minutes; time starting when the cabin altitude exceeds 25.000 ft and ending when it returns to 25.000 ft.

– END –

SPECIAL CONDITION	D-33 SC: Extendable Length Escape Slide
APPLICABILITY:	A380
REQUIREMENTS:	JAR 21.16, JAR 25.561 (b), JAR 25.810, JAR 25.1301, JAR 25.1309
ADVISORY MATERIAL:	N/A

BACKGROUND

The Airbus A380 design presents the particularity that the escape slide at Door 1 has an extendable length. Due to large variations in Door 1 sill height for various crash/gear out conditions, a fixed length slide design capable of meeting TSO-C69c requirements is not practical. Door 1 requires an evacuation system that has the ability to extend a section of inflatable in certain gear out scenarios.

The installation of Extendable Length Escape Slides constitutes a novel and unusual design feature for an aeroplane certified under JAR 25 and the applicable airworthiness requirements do not contain adequate or appropriate safety standards. A Special Condition is necessary to ensure a level of safety equivalent to that established in the applicable JAR in accordance with JAR 21.16(a)(1).

SPECIAL CONDITION

1. The extendable escape slide must receive TSO C69c authorization or equivalent.
2. With the following exceptions, the extendable escape slide must satisfy the requirements of JAR 25.810, including repeatability testing, in both the extended and unextended modes.
 - a. In addition to the requirements of JAR 25.810(a)(1)(iii), for usability in conditions of landing gear collapse, the extended escape slide must demonstrate an evacuation rate of 45 persons per minute per lane at the sill height corresponding to activation of the extension.
 - b. In addition to the requirements of JAR 25.810(a)(1)(iv), the extended escape slide must be capable of being deployed, and with the assistance of one person, remain usable in 22 knot winds directed from the critical angle, with the airplane on all its landing gear.
3. Requirements associated with JAR 25.1309(a) must be satisfied with escape slide extended in addition to the unextended mode. Pitch sensor tolerances and accuracy must be taken into account for this assessment.
4. Design of the “slide extension” warning must be such that, the cabin crew shall be made aware of a non usable slide, even if the A/C attitude changes during the evacuation. The ability to provide such a warning must be available for ten minutes after the A/C is immobilized on ground.

– END –

SPECIAL CONDITION	D-39 SC: Incorporation of Inertia Locking Device in Dynamic Seats
APPLICABILITY:	A380
REQUIREMENTS:	JAR 25.562, JAR 25.785
ADVISORY MATERIAL:	N/A

BACKGROUND

Airbus is allowing the incorporation of an inertia locking device (ILD) in some passenger seats on the A380 as a means to achieve compliance with particular aspects of JAR 25.562. In general, seats designed and tested to show compliance have, up until now, relied on either basic seat structure or in some cases, particular 'passive' energy absorbing features. The inertia locking device constitutes the first known application in commercial aerospace of an 'active' seat moving device to help achieve compliance, i.e. a system which mechanically deploys during the impact event. This is considered a novel design feature and one for which a special condition is needed to address requirements applicable to this feature in a seat.

SPECIAL CONDITION

- 1) **Level of Protection Provided by Inertia Locking Device(s) (ILD)**
 The ILD is a mechanically deploying feature of a seat with a fore/aft tracking system. The ILD will self-activate only in the event of a predetermined aircraft loading condition such as that occurring during crash or emergency landing. The ILD will interlock the seat tracking mechanism so as to prevent excessive seat forward translation. EASA considers that a minimum level of protection should be provided if the device does not deploy. It must be demonstrated by test that the seat and attachments, when subject to the emergency landing dynamic conditions specified in JAR 25.562 and with the ILD not deploying, do not suffer structural failure that could result in:
 - separation of the seat from the aircraft floor,
 - separation of any part of the seat that could form a hazard to the seat occupant or any other aircraft occupant,
 - failure of the occupant restraint or any other condition that could result in the occupant separating from the seat. However, failure of the occupant restraint may occur where it can be demonstrated that the seat occupant cannot form a hazard to any other aircraft occupant. This would normally only be agreed by the Agency on the basis of physical separation of the seat from other seats in the aircraft, for example in a mini-suite type arrangement.

- 2) **Protection Provided Below and Above the ILD Actuation Condition**
 The normal means of satisfying the structural and occupant protection requirements of JAR 25.562 result in a non-quantified but nominally predictable progressive structural deformation and/or reduction of injury severity for impact conditions less than the maximum specified by the rule. A seat using the ILD technology however involves a step change in protection for impacts below and above that at which the ILD activates and deploys to its 'retention' position. This could result in the effects of the impact, for example structural deformation and occupant injury criteria, being higher at an intermediate impact condition than that resulting from the maximum.
 It is acceptable for these effects to have such non-linear or step change characteristics provided that they do not exceed the allowable maximum at any condition at which the ILD does or does not deploy, up to the maximum severity pulse specified by the requirements. Tests must be performed to demonstrate this taking into account any necessary tolerances for deployment.

- 3) Intermediate Pulse Shape
The existing ideal triangular maximum severity pulse is defined in FAA AC 25.562.1B. EASA considers that for the evaluation and testing of less severe pulses, a similar triangular pulse should be used with acceleration, rise time, and velocity change scaled accordingly.
- 4) Protection over a range of crash pulse vectors
The device will be tested at the EASA 25.562 specified crash pulse vectors of 14g at 30 degrees to the vertical and 16g at the horizontal. In addition it shall be shown that the device will also operate at a range of crash pulse vectors between those specified.
- 5) Protection during Secondary Impacts
The design of the ILD shall be such that if there is more than one impact, for the final impact that is above the severity at which the device is intended to deploy, the maximum protection of the device must be provided.
- 6) Protection of Occupants other than 50th Percentile
The ILD shall not affect compliance of the seat and installation with CS 25 requirements, or those of this Special Condition, with respect to protecting the specified range of occupant sizes.
- 7) It must be shown that any inadvertent operation of the device, for example during extreme flight manoeuvres, does not affect the performance of the seat during a subsequent emergency landing.
- 8) The installation of the ILD on the seat shall be physically protected from any contamination likely to occur during operation, e.g. drink, food etc. The installation should also be protected against other foreign object ingress.
- 9) The effects of wear and criticality of manufacturing tolerances should be considered with respect to reliability and adverse effect on operation of the ILD. In addition other possible effects that may render the device inoperative must be taken into account such as aging/drying of lubricants and corrosion.
- 10) The design, installation and operation of the ILD shall be such that it is possible, by maintenance action, to check the functioning, i.e. movement, of the device in-situ.
- 11) A method of functional checking and a maintenance check interval should be established (if applicable).
- 12) If there is a need to include any means to release an inadvertently operated device (i.e. that has engaged in a non-crash condition where the seat could otherwise remain in-situ on the aircraft), this function shall not introduce additional hidden failures.

– END –

SPECIAL CONDITION	D-41 SC: Installation of suite type seating
APPLICABILITY:	A380
REQUIREMENTS:	JAR 25.785(h)(2), JAR 25.813(e)
ADVISORY MATERIAL:	FAA AC 25-17

BACKGROUND

The design of the A380 cabins incorporates the "mini-suites". Each of these mini-suites consists of a seat and surrounding "furniture". Complete enclosure can be achieved by moving sliding partition element(s). On initial consideration, it would appear that the proposed design is not in compliance with JAR 25.813 (e) and JAR 25.785(h)(2). However, further review of the design and consideration of the likely intent of the rule has indicated that an acceptable safety level might be achieved

JAR 25.813(e) requires that "No door may be installed in any partition between passenger compartments".

JAR 25.785 (h)(2) requires that "each seat located in the passenger compartment and designated for use during take-off and landing by a cabin crewmember required by the operating rules must be: to the extent possible, without compromising proximity to a required floor level emergency exit, located to provide a direct view of the cabin area for which the cabin crewmember is responsible".

A Special Condition is required to take into account the specific aspects of the "mini-suite" design into account; particularly Airbus developed a specific method of compliance for direct view applicable to special cabin areas such as mini-suites. This SC also takes into account a set of criteria developed by FAA.

SPECIAL CONDITION D-41 – Installation of suite type seating

1. Only single occupancy of the Mini-suite is allowed during taxi, take-off and landing
2. Mini-suite entrance can only provide access to the specific mini-suite
3. Mini-suites cannot provide an egress path for evacuation other than the path out of the mini- suite for its single occupant
4. Installation of the mini-suites must not introduce any additional obstructions or diversions to evacuating passengers, even from other parts of the cabin
5. The design of the doors and surrounding "furniture" above the cabin floor in the aisles must be such that each passenger's actions and demeanour can be readily observed by cabin crew members with stature as low as the 5th percentile female, when walking along the aisle.
6. The mini-suite doors must be open during taxi, take-off and landing
7. The hold open retention mechanism for mini-suite doors must hold the doors open under JAR 25.561(b) emergency landing conditions
8. There must be a secondary, backup hold open retention mechanism for the mini-suite doors that can be used to "lock" the doors in the open position if there is an electrical or mechanical failure of the primary retention mechanism. The secondary retention mechanism must hold the doors open under JAR 25.561(b) emergency landing conditions

9. There must be a means by which cabin crew can readily check, that all mini-suite doors are in the fully open and in the latched condition.
10. There must be means by which cabin crew can prevent the seated mini-suite occupant from operating the doors. This means is envisaged to be used in particular to secure the TTOL phases of the flight.
11. Appropriate placards, or other equivalent means must be provided to ensure the mini-suite occupants know that the doors must be in the open position for taxi, take-off and landing
12. Training and operating instruction materials regarding the proper configuration of the mini- suite doors for taxi, take-off and landing must be provided to the operator for incorporation into their cabin crew training programs and associated operational manuals.
13. The mini-suite must have an Emergency Passage Feature (EPF) to allow for evacuation of the mini-suite occupant in the event the door closes and becomes jammed during an emergency landing. This EPF may be through frangibility and /or a removable of emergency panel, or equivalent (such as dual sliding doors). The EPF must be easily broken /removed by the occupant of the mini-suite when the door becomes jammed. Trapping of any occupant is not acceptable and in no case shall the occupant using the EPF have to rely on another occupant to assist in passage. In addition a second path out of the mini suite must be provided. All ways to exit the mini suite in case of emergency must be demonstrated to work for a 5th percentile female and a 95th percentile male.
14. The height of the mini suite walls and doors must be such that a 95th percentile male can fit between them and the airplanes interior furnishing
15. No mechanism to latch the doors together in the closed position is allowed
16. The mini-suite doors must be openable from the inside or outside with 25 pounds force or less regardless of power failure conditions
17. If the mini-suite doors are electrically powered the doors must remained “locked” in the open position after power loss to the mini-suite
18. Mini-suites installation must maintain the main, cross aisles and passage ways
19. Mini-suite doors must not impede main aisle or cross aisle egress paths in the open, closed or translating position
20. The mini-suite doors must be openable even with a crowded aisle
21. The number of individual passenger seat modules shall not exceed 25% of the max.seating capacity of the specific cabin zone according to the A380 Type Certification Layout
22. For compliance to JAR 25.785(h)(2) the length of each main aisle adjacent to the seat modules must be visible, at least such that the main aisle part remaining unobservable does not exceed 50% of the main aisle width at the end of this cabin section (entrance area of last seat module), and

23. In case the main aisle width cannot be observed to at least 50% at the end of the cabin section (entrance area of last seat module), it is equivalent to have at least 80% of the seat module entrance areas in direct view from designated direct view seats, under the conditions of CRI D-9. An entrance area is considered visible, if a person standing in the main aisle, directly at the seat module entrance is observable. In line with the current assist space dimension a body depth of 12 inches is therefore assumed.
24. If special cabin areas are located in proximity to stairs, e.g. at the forward Upper Deck, the access to the stairs must be in view of the responsible cabin crewmember

**SPECIAL CONDITION D-41 - Installation of mini-suite type seating
Applicable to A380 for interior approved after 1st of Jan 2017**

1. Only single occupancy of the Mini-suite is allowed during taxi, take-off and landing.
2. The mini-suite entrance must only provide access to the specific mini-suite.
3. Mini-suites must not provide the required egress path for any passenger other than for its single occupant.
4. Installation of the mini-suites must not introduce any additional obstructions or diversions to evacuating passengers, even from other parts of the cabin.
5. The design of the doors and surrounding "furniture" above the cabin floor in the aisles must be such that each passenger's actions and demeanour can be readily observed by cabin crew members with stature as low as the 5th percentile female.
6. The mini-suite door(s) must be open during taxi, take-off and landing.
7. A hold open retention mechanism for mini-suite doors must be provided and must hold the doors open under JAR/CS 25.561(b) emergency landing conditions.
8. There must be a secondary, backup hold open retention mechanism for the mini-suite doors that can be used to "lock" the doors in the open position if there is an electrical or mechanical failure of the primary retention mechanism. The secondary retention mechanism must hold the doors open under JAR/CS 25.561(b) emergency landing conditions.
9. There must be a means to readily check that all mini-suite doors are fully open and in the latched condition.
10. There must be means to prevent the seated mini-suite occupant from operating the doors and thus ensure that the doors remain open during the TTOL phases of the flight.
11. Appropriate placards, or other equivalent means, must be provided to ensure the mini-suite occupants know that the doors must be in the open position for taxi, take-off and landing.
12. Operating instruction materials necessary to provide adequate compliance with SC 5, 9 and 10, considering also the number of individual mini-suites, shall be discussed and agreed with EASA and shall be provided to the operator for incorporation into their cabin crew training programs and associated operational manuals. This may affect the minimum

acceptable number of cabin crew required to operate the aeroplane.

13. In the TT&L configuration, the mini-suite must provide an unobstructed access to the main aisle having a width of at least 30 cm (12 inches) at a height lower than 64 cm (25 inches) from the floor, and of at least 38 cm (15 inches) at a height of 64 cm (25 inches) and more from the floor. A narrower width not less than 23 cm (9 inches) at a height below 64 cm (25 inches) from the floor may be approved when substantiated by tests found necessary by the Agency.
14. In addition, the mini-suite must have an Emergency Passage Feature (EPF) to allow for evacuation of the mini-suite occupant in the event a door closes and becomes jammed during an emergency landing. The EPF must provide a free aperture for passage into the aisle consistent with SC 13 or meeting the requirements of JAR/CS 25.807 applicable to a Type IV size emergency exit.
If the EPF consists of frangible and/or removable elements they must be easily broken/removed by the occupant of the mini-suite when a door becomes jammed.

If an EPF consists of dual independent sliding doors opening in opposite directions, the remaining unobstructed access width with one door in the fully closed position must be consistent with SC 13 or meet the requirements of JAR/CS 25.807 applicable to a Type IV emergency exit.

The occupant of the mini-suite must be made aware of the EPF and its way of operation.

In no case shall the occupant using the EPF have to rely on another occupant to assist in passage.

15. The height of the mini suite walls and doors must be such that a 95th percentile male can fit between them and the aeroplane interior furnishing.
16. No mechanism to latch the door(s) in the closed position shall be provided.
17. The mini-suite door(s) must be openable from the inside or outside with 25 pounds force or less regardless of power failure conditions.
18. If the mini-suite doors are electrically powered, in the event of loss of power to the mini-suite with the door(s) open, the door(s) must remain latched in the open position.
19. The mini-suites installation must not encroach into any required main aisle, cross aisle or passage ways.
20. No mini-suite door may impede main aisle or cross aisle egress paths in the open, closed or translating position.
21. The mini-suite doors must remain easily openable, even with a crowded aisle.
22. The seat of the Cabin Crew responsible for a mini-suite area must be located to provide a direct view of the egress path from each mini-suite and of each main aisle adjacent to the mini-suites.

INTERPRETATIVE MATERIAL D-41

a) IM to SC requirement 13: The requirements related to the access to the aisle for the occupant of the mini-suite are consistent with the requirements of JAR/CS 25.815 applicable to the 10 passengers or less seating capacity case and apply regardless of the number of mini-suites installed on the aeroplane. Permanent deformations of seats projecting into the access to the aisle must be taken into account in the assessment, considering the inertia loads specified in JAR/CS 25.561 and in JAR/CS 25.562.

b) IM to SC requirement 14: For mini-suites equipped with a single door, the EPF required by SC requirement 14 should be available in every position in which the door may jam, unless the hold open mechanisms of the mini-suite door are demonstrated to have a level of performance that significantly exceeds the requirements of SC 7 and SC 8. For example, if the door hold open mechanisms are shown to withstand the inertia loads of 25.562, taking into account also wear and tear caused by door operation, then it is acceptable to limit the demonstration of availability of the EPF only to the scenario in which the door jams in the fully closed position.

When the EPF is provided by an opening of a Type IV size exit, it does not necessarily need to meet the “step up” and “step down” dimensions defined in JAR/CS 25.807, but the EPF must be demonstrated to be useable by the range of occupants from a 5th percentile female to a 95th percentile male.

A smaller aperture than that specified in SC requirement 14, combined with an assessment of the possibility for an occupant to exit the suite by climbing over the surrounding wall (considering critical human physical abilities) might be considered acceptable. Use of this compliance approach must first be discussed and agreed with the Agency.

The design of the mini-suites will be reviewed to determine if a range of occupants can climb over the walls of the mini-suite and enter the aisle with acceptable ease and safety. Worst case permanent deformations resulting from required static and dynamic loading conditions of the components that will be used as steps, handholds etc. will need to be simulated or accounted for.

The number and size of occupants and variations in their physical strengths/abilities, to be considered in the evaluation of ease and safety of egress, will be those expected to be most critical, taking into account the geometry of the items to be negotiated and the free space provided for manoeuvre, and will be determined by the Agency.

c) IM to SC requirement 3: When all suite egress path obstructions are removed, the suite should not provide a required evacuation path for a passenger not coming out of the suite. No passage through the suite should be an evacuation path for passengers. Nevertheless, in the case of two adjacent suites, which are only separated by low furniture that may easily be climbed over, it is not necessary to provide means to forbid access to the adjacent suite. This however does not allow to count the adjacent suite access as one of the egress path required per SC requirements 13 and 14.

MEANS OF COMPLIANCE D-41

1. MOC to SC requirement 22. The Means of Compliance to demonstrate compliance to this Special Condition requirement of Cabin Crew direct view of the mini-suite area may be based on one of the two criteria defined below. Airplane level (and remaining zone) direct view requirements apply to the remainder of the cabin and exclude the mini-suite cabin area. Note that mirrors may be proposed, however the visibility should then be enhanced beyond the minimum requirements outlined below. In determining compliance, Cabin Crew head movement should be consistent with the documented current model MOC.
 - i. The length of each main aisle adjacent to the suite must be visible at least to the point of the entrance area of the last suite enclosure. An aisle is considered visible if at least 50% of the width of the aisle is visible.
 - ii. At least 80% of the suite entrances must be visible. An entrance is considered visible, if a person standing in the aisle at the suite entrance is observable, considering a body depth of 12”.

– END –

SPECIAL CONDITION	D-42 SC: Type C Passenger Exits
APPLICABILITY:	A380
REQUIREMENTS:	JAR 25.783, JAR 25.785, JAR 25.807, JAR 25.810, JAR 25.813
ADVISORY MATERIAL:	N/A

BACKGROUND

Some cabin configurations of the Airbus A380 may lead to consider Type C exit doors instead of the basic Type A doors. Type C doors have not been introduced yet in the current JAR/CS 25 requirements for emergency exit doors.

However, FAA has introduced a new Type C door category into FAR25 that is applicable. Although JAA prepared an NPA which in part introduces an equivalent door Type C and rating, this NPA (250-298) in its entirety is not considered to be mature. The purpose of this CRI therefore, is as in past programmes, to define a Special Condition for the A380 to enable certification of the Type C doors proposed by Airbus.

SPECIAL CONDITION

JAR 25 783(h): Each Type C passenger entry door in the side of the fuselage must meet the applicable emergency exit requirement of 25.807 to 25.813 for a Type II or larger passenger exit (including those identified below)

JAR 25 785(h): A flight attendant seat must be located near the Type C emergency exits

JAR 25 807(a)(8): A Type C exit is a floor-level exit with a rectangular opening of not less than 30 inches (762 mm) wide by 48 inches (1 219 m) high, with corner radii not greater than 10 inches (254 mm)

JAR 25 807(d)(2): The maximum number of passenger seats permitted for each pair of Type C exits is 55. There must be at least two Type C exits, one in each side of the fuselage

JAR 25 810(a)(1)(ii): Assisting means installed at Type C exits must be automatically erected within 10 seconds from the time the opening means of the exit is actuated

JAR 25 813(a): Passageways between individual passenger areas and those leading to Type C emergency exits must be unobstructed and at least 20 inches wide

JAR 25 813(b): An assist space must be provided at one side of a Type C exit

– END –

SPECIAL CONDITION	D-43 SC: Application of heat release and smoke density requirements to seat materials
APPLICABILITY:	A380
REQUIREMENTS:	JAR 25.853(d), Appendix F part IV & V; Part 21 §21A.16B
ADVISORY MATERIAL:	N/A

BACKGROUND

The flammability regulations applicable in particular to passenger seats are very explicit with respect to seat cushions but do not specifically address other parts of the seats. The ETSO/TSOs for seats (C39 and C127) only requires that seat components other than cushions comply with the tests described in Appendix F part 1 of JAR 25.

The regulations for interior panels, for aeroplanes with 20 or more passenger seats, set in JAR 25.853(d), require compliance to heat release and smoke emission tests specified in Appendix F part IV and V of JAR 25. Seatback installed food trays were excluded from this requirement, due to their small size and to the fact that the seats were separated from each other and would not therefore spread a fire through the cabin. As seats started to include sizable, non-metallic panels, the reference of food trays served as limiting case for assessment of applicability of heat release and smoke emission requirements.

There are now new seat design concepts that make some of the other components (other than the seat cushions) having dimensions such that they cannot be considered as small parts any more.

SPECIAL CONDITION

1. Except as provided in paragraph 3 of these special conditions, compliance with JAR 25, Appendix F, parts IV and V, heat release and smoke emission, is required for seats that incorporate non- traditional, large, non-metallic panels that may either be a single component or multiple components in a concentrated area in their design.
2. The applicant may designate up to and including 0.139 35 m² (1.5 square feet) of non-traditional, non-metallic panel material per seat place that does not have to comply with special condition N°1, above A triple seat assembly may have a total of 0.418 05 m² (4.5 square feet) excluded on any portion of the assembly (e.g., outboard seat place 0.092 9 m² (1 square foot), middle 0.092 9 m² (1 square foot), and in board 0.232 25 m² (2.5 square feet)).
3. Seats do not have to meet the test requirements of JAR 25, Appendix F, parts IV and V, when installed in compartments that are not otherwise required to meet these requirements
Examples include:
 - a) Airplanes with passenger capacities of 19 or less and
 - b) Airplanes exempted from smoke and heat release requirements
4. Only airplanes associated with new seat certification programs applied for after the effective date of these special conditions will be affected by the requirements in these special conditions. This Special Condition is not applicable:
 - a) On the existing airplane fleet and follow-on deliveries of airplanes with previously certified interiors,
 - b) For minor layout changes of already certified versions,

c) For major layout changes.

– END –

SPECIAL CONDITION	D-45 SC: Installation of Trolley Stowage/ Lift Systems with Proximity to Upper Deck Staircase
APPLICABILITY:	A380
REQUIREMENTS:	JAR 25.789, 25.1301, 25.1309, Part 21 §21A16B
ADVISORY MATERIAL:	VLTA OS-9 point 4

BACKGROUND

Normal trolley operation on a VLTA or A380 is not different to that on other large category aircraft and therefore the issuance of a special condition to address this issue was not found necessary in the past. However, Airbus is now proposing, on customer request, the installation of trolley stowage in close proximity to the entrance area of the staircases on the upper deck. Such installations introduce a possible need of trolley movement in the staircase entrance areas on the upper deck. Turbulence or a change of aircraft pitch during flight introduces the potential risk of trolleys falling down the staircase. In addition inappropriate mishandling by cabin crew could also heighten the risk.

To minimize the risk of trolleys falling down the stairs a Special Conditions is detailed here below.

SPECIAL CONDITION

1. Where trolley stowage is installed in a way that trolley movement in or into the stair entrance area cannot be avoided, means to prevent a trolley falling down the stairs must be provided.
2. In particular for a trolley stowage installation that requires cabin crew to move backwards in the stair entrance area, a means that alerts the cabin crew to the danger of falling down the staircase must be provided.
3. The means provided to prevent a trolley from falling down the stairs should not create a hazard to the cabin crew during trolley operation.
4. In case the stairs will have to be used under emergency conditions the protection means must be easy to stow and not create an impediment to persons using the stair.
5. Procedures should be provided to ensure safe operation and stowage of such means.

– END –

SPECIAL CONDITION	D-46 SC: Installation of Personal Electronic Device charging stowage in galley or cabin interior
APPLICABILITY:	A380
REQUIREMENTS:	N/A
ADVISORY MATERIAL:	N/A

BACKGROUND

Airbus is proposing interior designs that include special stowage compartments that are intended to recharge PED batteries when the PED is stowed inside. Subject compartments are typically part of galley or similar installations and do not belong to passenger seats. PED and their power supply (a common power supply are lithium-ion batteries) are passenger carry on board items with an unknown technical status. EASA has recognized that charging of lithium-ion batteries may lead to higher battery temperatures that can lead to a technical defect of the battery and start a battery fire. To ensure that the installation of PED stowage and charging compartment in aircraft cabin will not create an unacceptable safety hazard, a Special Condition is needed.

SPECIAL CONDITION

1. Each PED charging compartment must have a liner that has appropriate fire containment properties to stop the spread of a laptop computer battery fire to adjacent compartments. It must be demonstrated that the compartment/liner is appropriate to contain the maximum fire load that is related to the battery capacity per compartment. The compartment must be capable to contain the possible fire until the appropriate fire fighting can be applied.
2. Each compartment must be limited to the maximum battery capacity that will be allowed inside.
3. The design must allow immediate recognition of a smoke or fire inside the PED charging compartment.
4. Appropriate fire fighting procedures must be established.
5. A manual or automatic shutdown of the electrical power supply must be provided and sable in the event of smoke or fire detection in the laptop computer stowage compartments.
6. The relevant provisions of IM F-19-2 Guidance Material regarding the installation of ISPSS for PED's must be complied with.

– END –

SPECIAL CONDITION and IM	D-47 SC & IM: Installation of Inflatable Seat Belts
APPLICABILITY:	A380
REQUIREMENTS:	JAR 25.562, JAR 25.785
ADVISORY MATERIAL:	N/A

BACKGROUND

With respect to compliance with JAR 25.562 (c) (5), Airbus is proposing the application of inflatable lap belts as a means to reduce the potential for head injury in the event of an accident. The inflatable lap belt works similarly to an automotive airbag (supplemental restraint system), except that the airbag is integrated with the lap belt of the restraint system.

Inflatable lap belts are an unusual design feature on passenger seats that is not specifically addressed in CS/JAR 25. Therefore, a special condition is needed to address requirements particularly applicable to installation of those systems in an airplane.

SPECIAL CONDITION

1. HIC Characteristic

The existing means of controlling Head Injury Criterion (HIC) result in an unquantified but nominally predictable progressive reduction of injury severity for impact conditions less than the maximum specified by the rule. Airbag technology however involves a step change in protection for impacts below and above that at which the airbag device deploys. This could result in the HIC being higher at an intermediate impact condition than that resulting from the maximum.

It is acceptable for the HIC to have such a non-linear or step change characteristic provided that the value does not exceed 1 000 at any condition at which the inflatable lap belt does or does not deploy, up to the maximum severity pulse specified by the requirements. Tests must be performed to demonstrate this taking into account any necessary tolerances for deployment.

2. Intermediate Pulse Shape

The existing ideal triangular maximum severity pulse is defined in FAA AC 25.562.1. EASA considers that for the evaluation and testing of less severe pulses, a similar triangular pulse should be used with acceleration, rise time, and velocity change scaled accordingly.

3. Protection during Secondary Impacts

EASA acknowledges that the inflatable lap belt will not provide protection during secondary impacts after actuation. However, evidence must be provided that the post-deployment features of the installation shall not result in an unacceptable injury hazard. This must include consideration of the deflation characteristics in addition to physical effects. As a minimum, a qualitative assessment shall be provided.

Furthermore, the case where a small impact is followed by a large impact must be addressed. In such a case if the minimum deceleration severity at which the airbag is set to deploy is unnecessarily low, the bag's protection may be lost by the time the second larger impact occurs. It must be substantiated that the trigger point for airbag deployment has been chosen to maximize the probability of the protection being available when needed.

4. Protection of Occupants other than 50th Percentile

The existing policy is to consider other percentile occupants on a judgmental basis only i.e. not using direct testing of injury criteria but evidence from head paths etc. to determine likely areas of impact.

The same philosophy may be used for inflatable lap belts in that test results for other size occupants need not be submitted. However, sufficient evidence must be provided that other size occupants are protected.

A range of stature from a two-year-old child to a ninety-five percentile male must be considered.

In addition the following situations must be taken into account:

The seat occupant is holding an infant, including the case where a supplemental loop infant restraint is used:

The seat occupant is a child in a child restraint device.

The seat occupant is a pregnant woman

5. Occupants Adopting the Brace Position

There is no requirement for protection to be assessed or measured for set occupants in any other position or configuration than seated alone upright, as specified in FAA AC 25.562-1A (dated 19 January 1996). However, it must be shown that the inflatable lap belt does not, in itself, form a hazard to any occupant in a brace position during deployment.

6. It must be shown that the gas generator does not release hazardous quantities of gas or particulate matter into the cabin.
7. It must be ensured by design that the inflatable lap belt cannot be used in the incorrect orientation (twisted) such that improper deployment would result.
8. The probability of inadvertent deployment must be shown to be acceptably low. The seated occupant must not be seriously injured as a result of the inflatable label deployment, including when loosely attached. Inadvertent deployment must not cause a hazard to the aircraft or cause injury to anyone who may be positioned close to the inflatable lap belt (e.g. seated in an adjacent seat or standing adjacent to the seat). Cases where the inadvertently deploying inflatable lap belt is buckled or unbuckled around a seated occupant and where it is buckled or unbuckled in an empty seat must be considered.
9. It must be demonstrated that the inflatable lap belt when deployed does not impair access to the buckle, and does not hinder evacuation, including consideration of adjacent seat places and the aisle.
10. There must be a means for a crewmember to verify the integrity of the inflatable lap belt activation system prior to each flight, or the integrity of the inflatable lap belt activation system must be demonstrated to reliably operate between inspection intervals.
11. It must be shown that the inflatable lap belt is not susceptible to inadvertent deployment as a result of wear and tear, or inertial loads resulting from in-flight or ground manoeuvres likely to be experienced in service.

12. The equipment must meet the requirements of JAR 25.1316. Electro static discharge must also be considered.
13. The equipment must meet the requirements for CRI F-12 with an additional minimum RF test for the threat from passenger electronic devices of 15 Watts radiated power.
14. The inflatable lap belt mechanisms and controls must be protected from external contamination associated with that which could occur on or around passenger seating.
15. The inflatable lap belt installation must be protected from the effects of fire such that no hazard to occupants will result.
16. The inflatable lap belt must provide adequate protection for each occupant regardless of the number of occupants of the seat assembly or adjacent seats considering that unoccupied seats may have active inflatable lap belts, which may be buckled or unbuckled.
17. Each inflatable lap belt must function properly following any separation in the fuselage.
18. It is accepted that a material suitable for the inflatable bag that will meet the normally accepted flammability standard for a textile, i.e. the 12 second vertical test of JAR25 Appendix F, Part 1,

Paragraph (b)(4), is not currently available.

In recognition of the overall safety benefit of inflatable lap belts, and in lieu of this standard, it is acceptable for the material of the inflatable bags to have an average burn rate of no greater than 2.5 inches/minute when tested using the horizontal flammability test of JAR 25 Appendix F, part I, paragraph (b)(5).

INTERPRETATIVE MATERIAL

- 1) The effects of wear and criticality of manufacturing tolerances should be considered with respect to reliability and adverse effect on operation of the inflatable lap belt and/or normal belt function.
- 2) The inflatable lap belt should satisfy all the requirements of FAA TSO C22g when it does not deploy.
- 3) Any electrical battery should satisfy the requirement of BS 2G 239 (if applicable).
- 4) An appropriate periodicity and method of functional checking should be established (if applicable).
- 5) The equipment should satisfy the appropriate environmental requirements of DO-160C.
- 6) Software should satisfy the requirements of DO-1788 (if applicable).

– END –

EQUIVALENT SAFETY FINDING	D-48 ESF: Belly Fairing thermal/acoustic Insulation Materials
APPLICABILITY:	A380
REQUIREMENTS:	CS 25.856(b) CRI D-13
ADVISORY MATERIAL:	FAA AC 25.856-2A

BACKGROUND

In order to improve the overall aircraft flammability standard, the flame penetration requirements of §25.856(b) has been considered in TC CRI D-13. Airbus A380 design incorporates a carbon fibre belly fairing, over a substantial portion of the lower fuselage. Some of the insulation on the fuselage skin, under the belly fairing, does not comply with the requirements of 25.856(b), however, the fairing itself does. Airbus proposes an alternative method under the provisions of Part 21A.16B.

CONCLUSION

Final § 25.856(b) requires, for aircraft with a passenger capacity of 20 or greater, thermal/acoustic insulation materials (including the means of fastening the materials to the fuselage) installed in the lower half of the aircraft fuselage to meet the flame penetration resistance test requirements according to Part 25.856(b), appendix F part VII.

The Belly Fairing covers the lower half of the fuselage in its lower part. Per design, the Belly Fairing on A380 is a composite part, which is post-crash fire resistant in terms of 25.856(b). Consequently, the Belly Fairing can be used as an alternative method to meet the intent of 25.856(b), and thus the modification according to 25.856(b) of existing insulation materials inboard of the lowest part of the fuselage, could be avoided. Thus, Airbus proposes an alternative method under the equivalent level of safety provisions of Part 21A16B.

For A380, the total surface of the Belly Fairing is considered in the scope of the ESF, providing that the Belly Fairing constitutes the primary flame penetration protection. Areas that are already protected like the Lower Deck Cargo Compartment and the wing box are excluded of area of consideration. These areas where the Belly Fairing is installed, but that are already protected therefore have an additional retardant for the fire to penetrate the aircraft, but not the primary means to provide a burn through protection.

The critical case in terms of thickness and distance from the fuselage skin was identified and tested. In addition to tests of the basic fairing construction, the following tests have been performed according to 25.856(b) and Appendix F Part VII and documented under the following report numbers:

- 08-0108 (A340 - X junction)
- 08-0109 (A340 - T junction)
- 08-0398 (A380 - access panel)
- 08-0110, 08-0399 (A340 - Access panel)

The tests have successfully demonstrated the burn through resistance of the minimum 2 layers of hybrid/ composite as well as the X and T-junctions. Therefore, these junctions and panels are per design compliant with 25.856(b). Based on the test data, the latches for affected A380 access panels were modified to meet the test requirement.

Based on that analysis, it is demonstrated that the composite materials used for the Belly Fairing behave as a fire barrier, in terms of 25.856(b). The continuity is ensured with overlap 25.856(b) insulation materials, provided at the Belly Fairing contour. Where Equivalent Safety demonstration has been done already, the Belly Fairing provides an additional protection in terms of flame

penetration resistance. So, no additional means or modification for burn through insulation materials in the fuselage underneath the Belly Fairing is therefore required providing the respect of the 25.856(b) modification of the overlap area at the Belly Fairing contour.

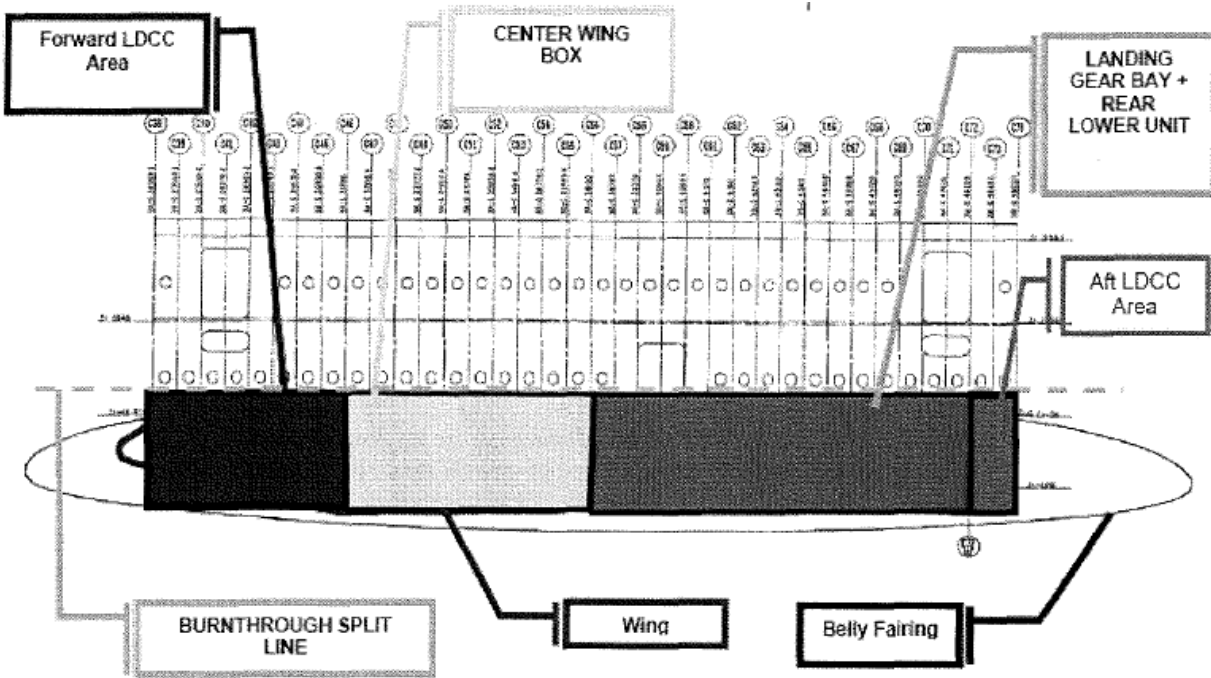

Figure 1: Overview of the Belly Fairing and affected area (example taken from A380)

– END –

EQUIVALENT SAFETY FINDING	D-49 ESF: Improved flammability standards for Lower Deck Crew
APPLICABILITY:	A380
REQUIREMENTS:	CS 25.856(b) CRI D-13
ADVISORY MATERIAL:	FAA AC 25.856-2A

BACKGROUND

In order to improve the overall aircraft flammability standard, the flame penetration requirements of §25.856(b) has been considered in TC CRI D-13. Airbus A380 Design typically does not have thermal/acoustic insulation installed on the fuselage skin in the bilge areas (the area below the lower lobe cargo floor). Instead, most Airbus airplanes have the insulation installed on the underside of the cargo floor, and per the flame penetration requirements of §25.856(b), this insulation would be subject to the fire penetration resistance test of Appendix F Part VII. Since implementing this level of fire protection into the insulation of the floor panels presents several design and implementation challenges, Airbus has proposed an alternative method of compliance under the provision of Part 21A16B.

CONCLUSION

The existing cargo floor panels have been tested and the results showed that the layers are flame penetration resistant in terms of 25.586 (b). The floor panel constitutes a fire barrier (Barrier 1), with a determined amount of openings (drain pans, Power Drive Units, etc...). The cargo compartment lining is qualified and certified according to 25.855(c), appendix F part III, and constitutes also a fire barrier (Barrier 2).

With respect to the burn through resistance of LDCC floor, the barrier 1 acts as a "filter". Airbus has demonstrated that the remaining heat flux that passes through it dissipates in the LDCC (forward and aft sections). The amount of heat flux to which the cargo lining and cargo ceiling (Barrier 2) are exposed reduces extremely significantly. The analysis performed shows that the heat flux to which the cargo ceiling (Barrier 2) can be exposed is below the maximum heat flux value mandated by the rule. Furthermore, tests performed by Airbus have demonstrated that the temperature at the level of the cargo ceiling (Barrier 2) never exceeds 1700°F (927°C) within 4 minutes.

Airbus has demonstrated that the LDCC constitutes an effective burn through barrier. The combination of Barrier 1 according to Part 25.856 (b) and of the Barrier 2 according to Part 25.855 (c) increases the time for evacuation in case of a post-crash fire sufficiently to meet the intent of the requirements of 25.856 (b).

Based on the LDCC demonstration, similar analysis has been conducted for all the different Lower Deck Compartments, and demonstrates that these compartments provide an effective flame penetration protection. This analysis takes into account the specificities of each Airbus design and covers the different type of existing Crew Rest Compartments/Lower Deck Facilities (Crew Rest Compartment Aft and Forward on A380).

In view of the above considerations and related test evidences, the LDCC on Airbus A380 should be considered compliant with part 25.856(b) through the here described equivalent level of safety approach.

The following explains the rationale in more detail:

- a) Barrier 1

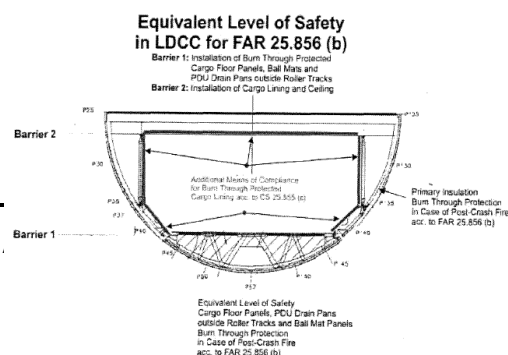

Disclaimer – This document is not exhaustive and it will be updated gradually. the TCDS.

Figure 1: Burn Through Concept

b) Barrier 2

Barrier 1 shows the burn through protected areas:

1. Installation of cargo floor panels (ATA530) made of burn through resistant layer (S-glass),
2. Installation of ball mat area in forward (FWD) and AFT lower deck cargo compartment (LDCC- ATA255 1 50) and
3. Installation of power drive unit (POU) drain pans in case of an installed cargo loading system (CLS - ATA255 1 50).

These protected areas contribute to the cargo floor resistance to burn through. This is used as a first means of compliance for burn through protection.

The second barrier (Barrier 2) is the installation of cargo lining within the LDCC. The LDCC lining is qualified and certified according to EASA CS 25.855 (c), appendix F part III. This is used as an additional means of compliance for burn through protection. The flammability standards of EASA CS 25.855 (c), which represent the Class "C" criteria according to CS 25.857 (c), are less stringent than the flammability standards in Part 25.856 (b), but will contribute to the overall burn through protection as a complement to the first barrier 1.

Detail analysis for heat flux and temperature exposing to the cargo lining is described in justification of heat flux and temperature analysis.

For A380, the certification philosophy will be effective. The analysis of the effected barrier 1 shows that in the design concept (installation of LDCC-CLS and cargo floor panels, worst case condition acc. to burn through resistance) max 33% of the entire cargo floor areas are not burn through protected (refer to LDCC Floor Areas for all Airbus Aircraft Types).

According to the test results given in the specific analysis (refer to several Figures below) the A380 have identified a max. of 33% of not burn through protected areas (barrier 1) acc. 25.856 (b), it is necessary to evaluate the heat flux and the temperature exposing to the LDCC ceiling (barrier 2) assuming an entire LDCC.

An estimation of the burn through resistance of the cargo ceiling already certified as a class "C" cargo compartment (CC) in combination with a partly burn through protected barrier 1 acc. to 25.856 (b) is considered.

The Burn through concept consists of two barriers:

Barrier 1:

- Lower deck cargo floor does not include all design features of an installed cargo loading system (CLS) to be burn through resistant acc. to 25.856 (b). Burns through resistant areas are:
 - Cargo floor panels (ATA530)
 - Ball mat area in forward and aft LDCC (ATA 255/50)
 - Power drive unit (PDU) drain pans outside roller tracks in case of an installed CLS (ATA 255/50)

Barrier 2:

- Cargo lining and ceiling are burn through resistant acc. to EASA CS 25.855 (c). Flammability standards of CS 25.855 (c) are less stringent (927 +/- 56 °C or 1700 +/- 100°F and 91 +/- 6 kW/m² or 8.0 +/- 0.5 Btu/ft² -sec) than the standards, of 25.856 (b) (1038 +/- 56 °C or 1900 +/- 100°F and 182 +/-9 kW/m² or 16.0 +/- 0.8 Btu/ft²-sec). Due to the complexity of the post-crash fire scenario, it is necessary to divide the analysis into two separate analyses: Heat flux analysis and Temperature influence to LDCC ceiling .

This mathematical analysis shall demonstrate that the combination of two fire barriers is equivalent to one fire barrier that would fulfill the requirements of 25.856 (b).

- a) The heat flux analysis demonstrates, that the combination of barrier 1 and barrier 2 will also provide increased time for evacuation in case of a post-crash fire and fulfils therefore the requirements of 25.856 (b).

Within the analysis the heat flux exposing to barrier 2 is determined.

- b) The worst-case regarding burn through is considered for all Airbus aircraft types and is defined by:
 - Maximum of burn through area in barrier 1 and
 - Minimum of LDCC capacity (=minimum of height of LDCC).The figure below shows, how many percent of the total cargo floor area are not burn through resistant c) The analysis represents the heat flux worst case for SA, LR and A380 (MB)

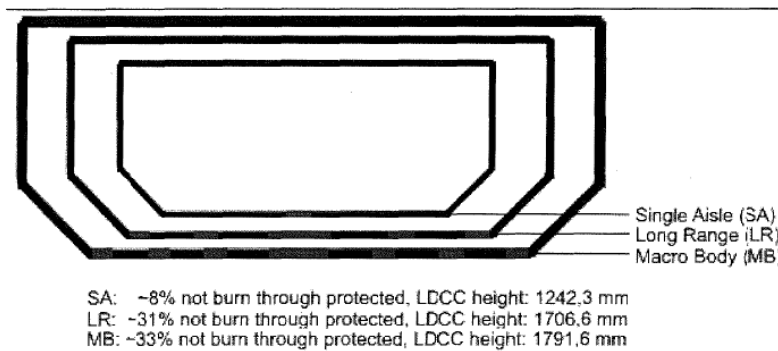

Barrier 1 (cargo floor) is partly burn through protected acc. to 25.856(b).

That means the cargo floor panels (ATA53), the ball mat area and the PDU drain pans (ATA255/50) are burn through protected. Thus at least 67% (depending on type of airplane) in A380 of the entire cargo floor area is burn through.

Due to the fact, that Barrier 1 acts as a "filter" the amount of heat flux exposing to the cargo lining and cargo ceiling (barrier 2) reduces enormously.

Within this analysis the heat flux exposing to the cargo ceiling will be evaluated.

- d) Basis of analysis:

Worst-case scenario: Burn through occurs in all not protected areas at the same time (when fuel ignited) in the entire LDCC.

Required heat flux and temperature acc. to 25.856 (b) expose to barrier 1 (figure below).

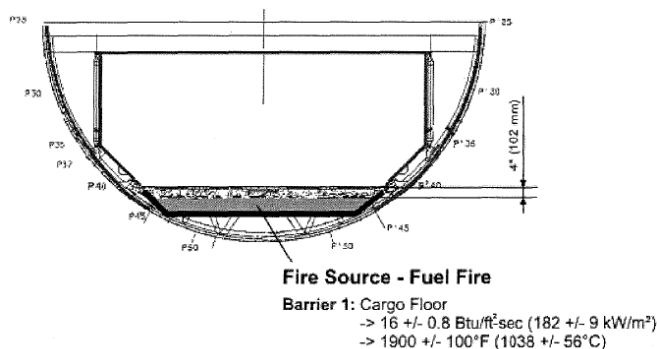

The design of CLS in LDCC regarding burn through resistance does not change markedly along its length. Therefore it is possible to continue with a 2-dimensional analysis (figure below).

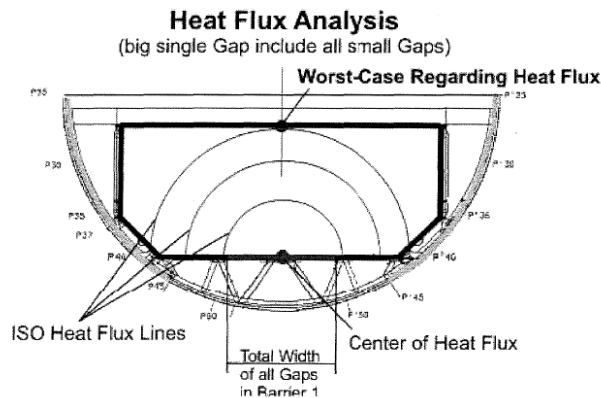

- e) Within a 2-dimensional analysis account the width of all not burn through resistant features in cross section of LDCC Multiply the total width of all gaps [m or ft] by 182 kW/m² or 16 Btu/ft²-sec (required heat flux acc. to 25.856 (b), Appendix F Part VII) result in [kW/m or Btu/ft-sec]
Multiply this value [kW/m or Btu/ft-sec] by factor of safety = 2
- f) The result is indicated in center line of cargo floor ("center of heat flux")
- g) The heat flux distributes circularly in LDCC
- h) Divide the result [kW/m or Btu/ft-sec] in center of heat flux by half perimeter of circle being tangent to cargo ceiling Maximum of heat flux exposing to cargo ceiling [kW/m² or Btu/ft²-sec]

To be compliant to the final rule the maximum of heat flux has to be < 91 kW/m² or 8.0 Btu/ft²-sec. The interfaces between the cargo compartment floor panels and the fuselage are not insulated, and consequently not changed with respect to compliance with §25.856(b).

With respect to the burn through resistance of LDCC floor, Barrier 1 has a "filter" function. The remaining heat flux from Barrier 1 dissipate in the LDCC (FWD and AFT section). Therefore the amount of heat flux impinging on the cargo lining and cargo ceiling (Barrier 2) reduces enormously. The heat flux analysis shows that the worst-case heat flux impinging on the cargo ceiling (Barrier 2) is 47 kW/m² for A380. The full-scale burn through tests has demonstrated that the temperature at the level of the cargo ceiling (Barrier 2) never exceeds 1700°F (927°C) within 4 minutes. The heat flux values are small compared to the required 91 kW/m² according to § 25.855 (e). The temperature remains systematically below the 927°C according to § 25.855 (c). The LDCC constitutes an effective burn through barrier. The combination of Barrier 1 according to § 25.856 (b) and Barrier 2 according to § 25.855 (c) provides sufficient burn through protection as required in the final rule.

EASA agreed that the Airbus rationale based on the above mentioned combination of test and analysis demonstrates that the design of the lower deck crew compartment of A380 provides an equivalent fire barrier to that required by 25.856(b) and therefore is compliant with CRI D-13 through an equivalent safety finding.

– END –

EQUIVALENT SAFETY FINDING	D-50 ESF: Composite Pressure Bulkhead Thermal / acoustic Insulation Materials
APPLICABILITY:	A380
REQUIREMENTS:	CS 25.856(b) CRI D-43
ADVISORY MATERIAL:	FAA AC 25.856-2A

BACKGROUND

In order to improve the overall aircraft flammability standard, the flame penetration requirements of §25.856(b) has been considered in TC CRI D-13. Airbus A380 design incorporates a carbon Fibber aft pressure bulkhead. The insulation on the aft pressure bulkhead does not comply with the requirements of 25.856(b), however, the bulkhead itself does. Airbus proposes an alternative method under the provisions of Part 21A.16B.

CONCLUSION

Final Part 25.856 (b) requires, for aircraft with a passenger capacity of 20 or greater, thermal/acoustic insulation materials (including the means of fastening the materials to the fuselage) installed near to the outer skin of the lower half of the aircraft fuselage to meet the flame penetration resistance test requirements according to Part 25.856 (b), appendix F part VII. The intent of the rule is to provide a fire barrier that will delay entry of post-crash fire into the passenger occupied areas of the aircraft. If an aircraft were to incorporate insulation not on the fuselage shell, but along the underside of the cargo floor, this insulation would be subject to the flame penetration test of final Part 25.856 (b).

For pressure bulkheads made from composite parts, the bulkheads will be covered with Thermal/acoustic insulation materials that meet 25.856(a) requirements. The present ESF demonstrates that the existing pressure bulkhead, designed with composite material are flame penetration resistant. As a consequence, the upgrade of the insulation materials inboard of the pressure bulkhead, according to the flammability standard of 25.856(b), will not improve the overall flame penetration protection of the current installation.

According to Part 21A.16B, alternate standards and design features that can meet the objective of the requirement can be used. Using the composite material of the pressure bulkhead is an alternative method to meet the intent of 25.856(b). Composite parts provide post-crash fire protection that is as good as the protection provided by 25.856(b) compliant insulation materials. So, the composite pressure bulkhead is an alternate design feature to 25.856(b) insulation materials to demonstrate an equivalent level of safety with respect to post-crash fires. With this approach, Airbus takes benefit of existing composite pressure bulk-head design and does not intend to extend or generalize it to new composite applications or designs. In the approach used in this demonstration, the premises under which the rule has been developed remain valid.

The composite pressure bulkhead is a full part, so that it provides a surface of protection above and below the split line (see figure), while the rule requires a fire barrier below the split line. The protection provided in terms of crash fire protection is therefore locally increased compared to the requirements of 25.856(b).

It is also clear that the composite pressure bulkheads that are fitted on existing Airbus designs will stay in the airplane. This is a reason why Airbus is taking credit of their fire properties in lieu of the insulation materials. Where 25.856(b) applies - the modification of insulation materials and fixation installed on the existing composite pressure bulkhead will not bring an improved fire penetration protection:

- The modification of the insulation and fixation on existing composite parts will not decrease the delay for a fire to penetrate into the passenger compartment, in terms of 25.856(b).

- On existing Airbus airplanes, the composite parts are remotely used to demonstrate compliance with 25.856(b), as only few of them are installed with insulation materials that are subject to the requirements of 25.856(b).

The pressure bulkhead made of CFRP, min thickness 3mm, is burn through resistant according to 25.856(b). Therefore it overtakes the function of a Thermal/Acoustic Burnthrough resistance fire barrier.

Tests performed according to 25.856(b) and Appendix F Part VII:

- A 3-ply/side CFRP Sandwich floor Panel (TN-RP0612414),
- A 3 mm CFRP pressure bulkhead Panel (Test Report 06-0783) and

Tests performed according to AC20-107A:

- A 1.75 mm CFRP Flap Panel (TN-RP0510607)

These tests demonstrate the burn through resistance of in minimum 3 layers CFRP with a min thickness of 0.32 mm/layer.

The results show that this material is a Fire Barrier, with equivalent performances in terms of 25.856 (b) protections, compared to the insulation materials.

Based on that analysis, it is demonstrated that the composite materials used for the pressure bulkhead behave as a fire barrier, in terms of 25.856(b) in combination with a thermal/acoustic insulation blanket. No additional means or modification for burn through is there-fore required on the insulation materials that are installed on the pressure bulkhead.

EASA agreed that the Airbus rationale based on the above mentioned combination of test and analysis demonstrates that the design of the composite rear pressure bulkhead of A380 provides an equivalent fire barrier to that required by 25.856(b) and therefore is compliant with CRI D-13 through an equivalent safety finding.

– END –

SPECIAL CONDITION and IM	D-52 SC & IM: Installation of structure mounted airbag
APPLICABILITY:	A380
REQUIREMENTS:	JAR 25.562, JAR 25.785
ADVISORY MATERIAL:	AC25.562-1B

BACKGROUND

With respect to compliance with JAR/FAR 25.562 (c) (5), Airbus is proposing the application of structure mounted airbags as a means to reduce the potential for head injury in the event of an accident. The structure mounted airbag works similarly to an automotive airbag (supplemental restraint system).

Inflatable restraint system in front of passenger operating opposite to flight direction will be denoted as structure mounted airbag.

Structure mounted airbags are an unusual design feature in the passenger seat environment that is not specifically addressed in CS/JAR/FAR 25. Therefore, a special condition and guidance material is needed to address requirements particularly applicable to installation of those systems in an airplane

SPECIAL CONDITION

1) HIC Characteristic

The existing means of controlling Front Row Head Injury Criterion (HIC) result in an unquantified but normally predictable progressive reduction of injury severity for impact conditions less than the maximum specified by the rule. Airbag technology however involves a step change on protection for impacts below and above that at which the airbag device deploys. This could result in the HIC being higher at an intermediate impact condition than that resulting from the maximum.

It is acceptable for HIC to have such a non-linear or step change characteristic provided that the value does not exceed 1000 at any condition at which the structure mounted airbag does or does not deploy, up to the maximum severity pulse specified by the requirements. Tests must be performed to demonstrate this taking into account any necessary tolerances for deployment.

2) Intermediate Pulse Shape

The existing ideal triangular maximum severity pulse is defined in FAA AC 25.562.1. EASA considers that for the evaluation and testing of less severe pulses, a similar triangular pulse should be used with acceleration, rise time, and velocity change scaled accordingly.

3) Protection During Secondary Impacts

EASA acknowledges that the structure mounted airbag will not provide protection during secondary impacts after actuation. However, evidence must be provided that the post-deployment features of the installation shall not result in an unacceptable injury hazard. This must include consideration of the deflation characteristics in addition to physical effects. As a minimum, a qualitative assessment shall be provided.

Furthermore, the case where a small impact is followed by a large impact must be addressed. In such a case if the minimum deceleration severity at which the airbag is set to deploy is unnecessarily low, the bag's protection may be lost by the time the second larger

impact occurs. It must be substantiated that the trigger point for airbag deployment has been chosen to maximize the probability of the protection being available when needed.

4) Protection of Occupants other than 50th Percentile

The existing policy is to consider other percentile occupants on a judgmental basis only i.e. not using direct testing of injury criteria but evidence from head paths etc. to determine likely areas of impact.

The same philosophy may be used for structure mounted airbags in that test results for other size occupants need not be submitted. However, sufficient evidence must be provided that other size occupants are protected.

A range of stature from a two-year-old child to a ninety-five percentile male must be considered.

In addition the following situations must be taken into account:

- The seat occupant is holding an infant, including the case where a supplemental loop infant restraint is used:
- The seat occupant is a child in a child restraint device.
- The seat occupant is a pregnant woman

5) Airbag Deployment

Evaluation of the deployment of the airbag must take into account the deflection or deformation of the installation during the crash pulse. If installed in a monument used for stowage, this should include the possible range of loading conditions. The effects of any loads imposed by the airbag deployment on the positioning of the airbag should also be included in the evaluation.

The HIC test may be performed with the airbag deploying from a rigid test fixture provided that the above factors and the occupant size considerations in paragraph 4) are taken into account. A rational analysis supported by static deployment tests would be acceptable.

6) Occupants Adopting the Brace Position

There is no requirement for protection to be assessed or measured for seat occupants in any other position or configuration than seated alone upright, as specified in FAA AC 25.562-1B (dated 1 October 2006). However, it must be shown that the structure mounted airbag does not, in itself, form a hazard to any occupant in a brace position or a person in between the brace position and upright position during deployment.

7) It must be shown that the gas generator does not release hazardous quantities of gas or particulate matter into the cabin.

8) The probability of inadvertent deployment must be shown to be acceptably low. The seated occupant must not be seriously injured as a result of the structure mounted airbag deployment. Inadvertent deployment must not cause a hazard to the aircraft or cause injury to anyone who may be positioned close to the structure mounted airbag (e.g. seated in an adjacent seat or standing adjacent to the airbag installation or the subject seat). Cases where the inadvertently deploying structure mounted airbag is near a seated occupant or an empty seat must be considered. The above must be demonstrated or the probability of the inadvertent deployment must be shown to be in accordance with the severity of the failure.

9) It must be demonstrated that the structure mounted airbag when deployed does not impair access to the seatbelt or harness release means, and does not hinder evacuation, including consideration of adjacent seat places and the aisle.

- 10) There must be a means for a crewmember to verify the integrity of the structure mounted airbag activation system prior to each flight, or the integrity of the structure mounted airbag activation system must be demonstrated to reliably operate between inspection intervals.
- 11) It must be shown that the structure mounted airbag is not susceptible to inadvertent deployment as a result of wear and tear, or inertial loads resulting from in-flight or ground manoeuvres likely to be experienced in service.
- 12) The equipment must meet the requirements of JAR 25.1316 with associated guidance material IM S-1006 for indirect effects of lightning. Electro static discharge must also be considered.
- 13) The equipment must meet the requirements for HIRF (SC S-10.2 and IM S-10.2) with an additional minimum RF test for the threat from passenger electronic devices of 15 Watts radiated power.
- 14) The structure mounted airbag mechanisms and controls must be protected from external contamination associated with that which could occur on or around passenger seating.
- 15) The structure mounted airbag installation must be protected from the effects of fire such that no hazard to occupants will result.
- 16) The structure mounted airbag must provide adequate protection for each occupant regardless of the number of occupants of the seat assembly or adjacent seats considering that unoccupied seats may have active structure mounted airbag.
- 17) The structure mounted airbag must function properly after loss of normal aircraft electrical power and after a transverse separation in the fuselage at the most critical location. A separation at the location of the airbag does not have to be considered.
- 18) It is accepted that a material suitable for the inflatable bag that will meet the normally accepted flammability standard for a textile, i.e. the 12 second vertical test of JAR25 Appendix F, Part 1, Paragraph (b)(4), is not currently available.
In recognition of the overall safety benefit of structure mounted airbags, and in lieu of this standard, it is acceptable for the material of inflatable bag to have an average burn rate of no greater than 2.5 inches/minute when tested using the horizontal flammability test of JAR25 Appendix F, part I, paragraph (b)(5).
- 19) If lithium-ion non-rechargeable batteries are used to power the inflatable restraint, the batteries must be RTCA DO-227 and Underwriters Laboratory (UL) compliant. The use of rechargeable lithium-ion batteries may require additional special conditions.
- 20) Structure mounted airbag systems should not introduce additional hazards in respect to occupant safety when compared to certified systems.
- 21) In case structure mounted airbag systems are installed in or close to passenger evacuation routes (other than for the passenger seat the airbag is mounted for) a possible impact on emergency evacuation (e.g. hanging in the aisle, building a potential trip hazard, etc.) should be evaluated.

INTERPRETATIVE MATERIAL

- 1) The effects of wear and criticality of manufacturing tolerances should be considered with respect to reliability and adverse effect on operation of the structure mounted airbag function. Any electrical battery should satisfy the requirement of BS 2G 239 (if applicable).
- 2) An appropriate periodicity and method of functional checking should be established (if applicable).
- 3) The equipment should satisfy the appropriate environmental requirements of DO-160G.
- 4) Software should satisfy the requirements of DO-178B (if applicable).

– END –

SPECIAL CONDITION and IM	D-55 SC & IM: Shower Installation
APPLICABILITY:	A380
REQUIREMENTS:	25.831, 25.1309, 25.1447(c)(1), JAR 25X799 or CS 25.1365(c)
ADVISORY MATERIAL:	N/A

BACKGROUND

Airbus has submitted to EASA a design proposal for a cabin installation, which includes a shower that could be used during flight by passengers.

The proposed installation is a novel and unusual design feature and the applicable airworthiness codes do not provide standards for this type of installation for the following aspects:

- Water systems
- Ventilation rate
- Firm handhold
- Emergency warning, return to seat
- Oxygen availability
- Emergency accessibility

Consequently, in addition to generally applicable requirements, EASA considers that the design must comply with the Special Conditions and the Interpretative Material here below.

SPECIAL CONDITION

1. A return to seat audible and visual indication, readily detectable by shower occupants, must be activated at the same time as the fasten seat belt signs in the main cabin.
2. In case of depressurisation or drop of the oxygen masks in the cabin there must be a visual and audible indication to an occupant inside the shower. The oxygen provisions must readily be available without stepping outside the shower (reaching through open door is acceptable).
3. Placards must be installed to indicate that the shower must not be used for the stowage of cargo or passenger baggage.
4. Appropriate firm handhold features must be available in the shower area.
5. The shower must be designed to preclude anyone from becoming trapped inside the shower. If a locking mechanism is installed, it must be capable of being unlocked from the inside and the outside without the aid of special tools.
6. Shower walls should typically be considered as partitions within occupied compartments under CS 25.365(g). If venting is used to limit pressure build up e.g. through the shower door opening, the opening element must be shown not to impact the likely position of occupants using the shower and compartment it is located within.

INTERPRETATIVE MATERIAL

- a) An analysis should be performed to identify possible water leakage failures, and to show that appropriate safety features have been included in the design.
- b) The shower compartment must be considered a passenger compartment in terms of the need for ventilation.
The applicant should justify that adequate ventilation is provided within the shower. The cabin air itself can be considered as “fresh air” source for the air supply of the shower.
- c) The shower air outflow should be directed into aircraft areas unaffected by the high water content of the air flow.
- d) Depending on the design of the shower, the Isolated Compartments CRI may be applicable.
- e) Electrical power outlets shall be designed and installed according to the appropriate relevant provisions of IFE-ISPSS CRI F-19 and, in addition, to the part of Executive Power System (EPS) current policy indicated below:

If EPS power outlets are installed into rooms or areas where sources of water (e.g. faucets) or a shower (Bathroom) are installed, the following requirements shall be fulfilled:

- The distance between a faucet and the outlets should be not less than 0,6m.
- If the distance from the outlet to the source of water is between 0,3m and 0,6m, outlets shall be covered with a lid or shall be installed so that the front-side of the outlet shows straight downward.
- The shower cubicle shall be closed up to the ceiling.
- No outlets are allowed inside the cubicle.
- The power outlets may not be placed within the encompassing radius of 0,6m at the shower cubicle door.
- GFI protection with fault current max 30mA or galvanic isolation (isolation transformer) shall be used.

– END –

EQUIVALENT SAFETY FINDING	D-56 ESF: Shower Installation
APPLICABILITY:	A380
REQUIREMENTS:	25.785(d)
ADVISORY MATERIAL:	N/A

BACKGROUND

The A380-800 will be equipped with B/C seats making an angle of 24° with the aircraft longitudinal axis.

JAR 25.785(d) requires that:

“Each occupant of a seat (see ACJ 25.785(d)) that makes more than an 18-degree angle with the vertical plane containing the aeroplane centreline must be protected from head injury by a safety belt and an energy absorbing rest that will support the arms, shoulders, head and spine, or by a safety belt and shoulder harness that will prevent the head from contacting any injurious object.”

JAR 25.562(b) test conditions consider only forward and aft facing seats, while side facing seats (90° angle with the aircraft longitudinal axis) are considered a novel design on transport category aircraft, which have to be installed under consideration of additional criteria in form of a Special Condition (SC) in order to maintain the level of safety intended by the regulation.

EQUIVALENT SAFETY FINDING

Following the same approach as for the B/C seat case documented in A330 CRI E-27, dynamic developmental tests have shown that for this installation the test dummy behaves like in a forward facing impact. This is supported by the relatively low seat angle itself (24° for the A380 B/C seat compared to 23.5° for the A330 B/C seat) but also by the design of the seat surroundings, which allows a free forward alignment of the test dummy during the impact.

As for typical forward facing seating there is no obstruction on the seat or surroundings that neither creates a risk to the occupant nor imposes to the upper dummy body any severe side twisting effect during the impact.

Only the shape of the monument in front rather than the seat angle itself may generate a certain dummy side movement. This is comparable to observation made on forward facing seat arrangements, where the shape of the seat or monument in front of the seat introduces body twisting effects.

The development tests show that the seat design allows the ATD to align with the deceleration vector, thus it can be concluded that the application of energy absorbing rests for arms, shoulders, head and spine as per CS25.785(d) is not required.

Therefore, Airbus consider that based on the development test conclusions and a qualitative assessment of the videos, an equivalent level of safety of occupant protection to the part of JAR 25.785(d) requiring an “Energy absorbing rest for the upper body parts or a shoulder harness”, can be demonstrated by applying the test conditions of 25.562(b).

The airbag-belt system which is part of the seat design is to demonstrate compliance to JAR 25.562(c)(5).

EASA agreed that it may be possible to design a seat installation at an angle above the value of 18° as set in JAR 25.785(d), meeting the required safety level of occupant safety, without providing an energy absorbing rest or shoulder harness.

Airbus pointed out that the design of the seat and the surrounding items have been carefully chosen to maximize the ability of the occupant to align with the deceleration vector during the impact. EASA is prepared to accept this as a compensating factor as required by 21A.21.

Similar to A330 CRI E-27 the installation of an airbag-belt system may be required if the occupant does not realign as much as expected (considering an acceptable forward facing seat under the provisions of JAR 25.785(d)) or if testing shows that the airbag (that is part of the seat design) plays a significant role in maintaining acceptable protection.

In addition it was agreed in A330 CRI E-27 that ATD internal force and moment measurements, in addition to those required by JAR 25.562 (c), are necessary for comparative purposes. These can be taken during dynamic testing and compared with values from tests of a seat installed at less than 18 degrees to the aircraft centreline. It should be noted that this approach cannot at present involve consideration of absolute values as research data do not exist to back this up. Rather, this will involve a check that the values observed are of comparable magnitude and range and will provide confidence that the mitigating factors are achieving the desired outcome.

EASA agreed that an equivalent level of safety to JAR 25.785 (d) for passenger seats that are installed in the aircraft making an angle of 24° with the aircraft longitudinal axis, can be shown acceptable by the approach outlined above.

– END –

SPECIAL CONDITION and IM	D-57 SC / IM / MOC: Installation of high wall suite type seating
APPLICABILITY:	A380
REQUIREMENTS:	JAR 25.785(h)(2), 25.813(e), 25.854, 25.857(b)
ADVISORY MATERIAL:	FAA AC 25-17A

BACKGROUND

Airbus has submitted to EASA a project proposal for installation of High Wall Passenger Seating Units on A380.

Suite designs with wall surrounds close out to the ceiling/bin area directly above the walls and with privacy screen that can be closed during flight are considered novel features, not envisioned in applicable JAR/CS 25 rules such as 25.785(h), 25.813(e), 25.854, 25.857(b), etc. and therefore, in accordance with 21A.16B, Special Conditions are necessary to address the proposal.

SPECIAL CONDITION

1. Only single occupancy of the suite is allowed during taxi, takeoff and landing.
2. There must be two independent egress paths to allow sufficient access and egress to the suite.
 - a. One egress path must be provided by a floor level entrance providing a 38 cm (15") wide passage.
 - b. One egress path must be provided by a floor level entrance providing a 38 cm (15") wide passage, or a non-floor level opening of not less than 48 cm (19") wide by 66 cm (26") high size.
3. If an egress path can be obstructed by a door, a screen or similar feature, then:
 - a. the obstruction must be able to be removed with a maximum force of 113N (25 lbf),
 - b. the obstruction feature must have no hold closed retention mechanism.
4. There must be one emergency passage feature that will ensure that occupants will not be trapped at any time in flight.
5. The suite must not provide the required evacuation path for any passenger other than for its single occupant.
6. Each suite occupant must be provided with supplemental oxygen system equivalent to that provided for the passenger cabin, however chemical oxygen generator installation must meet CS 25.795(d) at amdt 17.
7. A Cabin Crew must be responsible for a suite area comprising of no more than 6 suites when accomplishing the requirements of this Special Condition.
8. Each egress path obstruction must be removed during taxi, takeoff and landing. The Cabin Crew must be able to easily and readily ensure and check the obstruction removal.
9. The seat of the Cabin Crew responsible for a suite area must be located to provide a direct view of the egress path from each suite and of each main aisle adjacent to the suites.

10. The Cabin Crew must be able to determine the actions and demeanour of the occupants of the suite at any time throughout the flight without additional effort.
11. One egress path obstruction must remain open when the suite is unoccupied.
12. The Cabin Crew duties must be supported by appropriate placards, or other equivalent means, ensuring suite occupant awareness of the design and procedures required by this Special Condition.
13. A smoke or fire detection system is required to monitor each suite area, and must provide:
 - a. a visual indication to the Flight Crew within one minute after the start of a fire,
 - b. an aural warning in the suite area where detection has occurred, and a warning in the passenger cabin, which indicates the location of the event.
14. The design of the suites and the firefighting equipment location must allow crewmembers to conduct effective firefighting procedures.
15. The suite firefighting procedures must be conducted without causing a hazardous condition to passengers due to excess quantities of smoke and / or extinguishing agent accumulating and remaining in other occupied areas.
16. Large enclosed stowage compartments are not allowed within the suite.
17. Where a waste disposal receptacle is fitted, it must be equipped with an automatic fire extinguisher that meets the applicable lavatory waste disposal receptacle requirements.

MATERIAL

1. IM to SC 2, 3, 4, 8, 10 & 11. This Special Condition allows obstruction to both suite egress paths. This is mitigated by the removal of egress path obstruction during taxi, takeoff and landing, the in-flight demeanour visibility, the opening of egress path obstruction when the suite is unoccupied, and the design of one emergency passage feature for in-flight use in the unlikely event of the two egress paths obstruction being jammed.
2. IM to SC 2 & 3. When the movement or removal of an egress path obstruction or emergency path feature involves electrical power, the required functions must be fulfilled, regardless of power failure condition, and:
 - a. it should not be hazardous to occupants, using ARP 5526 guidance or equivalent.
 - b. it should be protected from damage caused by blocking items, misalignment of the mechanism and minor deformation of the structure.
 - c. it should prevent overheating of the components that could be an ignition source.
3. IM to SC 3 & 4. Certain features such as curtains may be considered as non-obstructing.
4. IM to SC 3a. If the obstruction feature itself is translating along the suite wall or removable, it must be movable or removable from inside or outside. If the obstruction feature itself is not translating along the suite wall or removable, it must be deployable in the direction of the suite occupant egress, i.e. outside of the suite.
5. IM to SC 3b. Certain features such as magnets or other non-mechanism type features may be considered as non- holding close, however the compliance to SC 3a must then be demonstrated with closing feature in place.

6. IM to SC 5. When all suite egress path obstructions are removed, the suite should not provide a required evacuation path for a passenger not coming out of the suite.
 - a. No passage through the suite should be an evacuation path for passengers. Nevertheless, in the case of two adjacent suites, which are only separated by low furniture that may easily be climbed over, it is not necessary to provide means to forbid access to the adjacent suite. This however does not allow to count the adjacent suite access as one of the egress path required per SC 2.
 - b. No access sharing design is acceptable; floor level entrance can only provide access to the specific suite.
7. IM to SC 6. The oxygen masks provided in the suites must be equivalent to that provided in the passenger cabin
 - a. It must include an automatic drop down system with means by which the oxygen masks can be manually deployed from the flight deck.
 - b. Simultaneously with mask drop, an aural warning and illumination should be provided, sufficient for occupants to locate a deployed oxygen mask.
 - c. It should be understood that the oxygen masks within the suites are assumed to be not available for the cabin attendant moving about the cabin, since suite obstructions may be closed in flight. As such, additional oxygen or oxygen indication in the suite area is likely necessary to meet the applicable 10% coverage requirement and applicable uniform distribution requirement.
 - d. Relevant chemical oxygen generator guidance is provided in AMC 25.795(d).
8. IM to SC 7. The requirement of a maximum of 6 mini-suite per responsible Cabin Crew, and any specific Cabin Crew tasks per this Special Condition, do not necessarily translate into requirement of addition to the total number of Cabin Crew required for the entire aircraft. The number of Cabin Crew and location of Cabin Crew seats should consider the number of individual suites and suite areas, and the design and installation features within those suites.
9. IM to SC 7 & 9. More than one attendant may be used to meet the direct view requirements of one given suite area.
10. IM to SC 8. For emergency evacuation situations, the suite area must maintain the applicable minimum dimension requirements for main aisles, cross aisles and passageways.
 - a. Only temporary encroachment into these applicable minimum dimension requirements is allowed during the removal of an egress path obstruction.
 - b. Installation of the suite must not introduce any additional obstacles or diversions to evacuating passengers, even from other parts of the cabin.
11. IM to SC 8 & 14. The suite and area design should ensure that:
 - a. Obstruction features deploying out of the suite should never encroach in the deployment path of any other cabin feature.
 - b. The installation of the suites should not create a path to the exit that is difficult to traverse in an emergency such as multiple 'zig zags' along the aisle or multiple sharp aisle transitions.
12. IM to SC 8. The removal of the obstruction is expected to be performed prior to taxi and prior to landing; it is to be maintained for the whole duration of taxi, takeoff and landing.
13. IM to SC 8. The removal of an egress path obstruction must provide the full restoration of the egress path by removal of the obstruction feature itself or any other acceptable equivalent Means.

14. IM to SC 8. The Cabin Crew ability to easily and readily check that an egress path obstruction is removed is not a direct view requirement, and therefore does not need to be fulfilled by Cabin Crew seating at their station.
15. IM to SC 8, 10. Suite lighting should be provided to ensure the demeanour, entrance and obstruction removal system visibility of this Special Condition under all lighting conditions.
 - a. Suite entrance illumination must be provided meeting the applicable cabin general illumination requirements.
 - b. All egress path obstruction removal systems should be well illuminated even in conditions of occupant crowding around the egress path.
 - c. Suite emergency lighting must meet the applicable emergency lighting requirements.
 - d. This does not apply to SC 9 and SC 11.
16. IM to SC 10. The occupant demeanour visibility may exclude brief periods (such as for changing), if restricted to a limited area and appropriately controlled by procedure. Alternatively, a brief temporary period without visibility into each suite is acceptable provided that no action is required to restore visibility.
17. IM to SC 10. During abnormal situation, e.g. depressurization, severe turbulence, etc., the Cabin Crew check of the actions and demeanour of the occupants of the suites must be delayed until it is deemed safe to do so.
18. IM to SC10 It is not considered as additional effort for the Cabin Crew to utilize a passive viewing feature for demeanour check that requires a Cabin Crew to move their body towards the suite and turn their head to see within the suite, without involving an activation of the viewing system.
19. IM to SC 11. The opening of an egress path obstruction required when the suite is unoccupied is relevant to flight phases outside taxi, takeoff and landing. The intent is to restore a fire protection capability similar to the remainder of the cabin (i.e. not as in a lavatory). An egress path is considered open if it creates a usable access path.
20. IM to SC 12. In addition to the placards, to provide appropriate occupant awareness, the aircraft or suite installation must include an aural emergency alarm system meeting the applicable public address requirements.
21. IM to SC 13. The smoke detection aural warning must be readily detectable by at least one Cabin Crew, taking into consideration the Cabin Crew positioning throughout the passenger cabin during various phases of flight.
22. IM to SC 14. The design of the suites must allow crewmembers equipped for firefighting to have unrestricted access to the compartment.
23. IM to SC 14. The firefighting equipment must meet applicable “readily accessibility” requirements to enable a crewmember to initiate timely and effective firefighting considering the suite area configuration.
24. IM to SC 14. The firefighting procedures include methods to search the suite compartment for fire source. If the firefighting procedures methods to search the suite are not different than current cabin procedures used by the airline, then no further updates to the procedures are necessary.
25. IM to SC 14. The installation of electrical power supply capable to be used by the occupants must meet applicable fire risk requirements.

26. IM to SC 16. Enclosed stowage compartment impacts the smoke detection capability. The intent is to avoid sealed compartment with insufficient smoke evacuation into the suite. The crewmembers' ability to effectively reach any part of the compartment with the contents of a hand fire extinguisher should also be considered. Without further justification, a compartment is not considered large if smaller than 1.6 m³ (57 cubic feet).

MEANS OF COMPLIANCE

1. MOC for SC 2 & 4. Each unobstructed egress path and emergency passage feature must be demonstrated to be usable for the range of occupant, from a 5th percentile female through a 95th percentile male.
2. MOC for SC 3 & 4. The substantiation of non-obstructing aspect of features such as curtains must include a demonstration of the ability to walk through without help of hands and without significant effort and without significant delay, and must include insurance of open configuration at taxi, takeoff and landing through appropriate design, Cabin Crew procedure and placard.
3. MOC for SC 4. The emergency passage feature must be demonstrated considering the specific cabin layout of the suite area. The demonstration must include showing that the feature can be easily manipulated and does not impede egress.
4. MOC for SC 4. The emergency passage feature requirement may be complied with by design of a frangible, a movable feature, a removable feature, or a permanently open area. The emergency passage feature must be functionally independent of the obstruction removal, since its use is anticipated when the obstruction removal is jammed.
 - a. A frangible feature is one that it is easily broken by the occupant of the suite. It can be a subpart or subsystem of the egress path obstruction or independent of the egress paths.
 - b. A movable feature is a panel that is stowed within the suite structure (e.g. a sliding panel) and is easily operated by the occupant.
 - c. A removable feature is a panel that is easily removed and remotely stowed by the Cabin Crew without the use of tools.
 - d. A permanently open area can be an opening within an egress path obstruction, or independent of the egress paths. The opening must be without obstruction, or fitted with non-obstructing feature demonstrated by the ability to go through without additional help of hands, and without significant effort and without significant delay.
5. MOC for SC 7. The number of Cabin Crew and location of Cabin Crew seats shall be agreed with the Authority.
6. MOC for SC 8. If the removal of egress path obstruction with full restoration of the egress path is accomplished by the removal of the obstruction feature itself, the following conditions should be satisfied.
 - a. It must be easily performed by the cabin attendant without the use of tools.
 - b. The stowage for the removable egress path obstruction feature must fit the obstruction feature size and comply with applicable stowage compartment requirements.
 - c. Training and operating instruction materials regarding the stowage location (for a removable egress path obstruction feature) should be provided to the operator for incorporation into their cabin crew operational manuals.

7. MOC for SC 8. If the removal of egress path obstruction with full restoration of the egress path is to be accomplished by hold open retention of the movable obstruction, the following conditions should be satisfied.
 - a. For each egress path obstruction, there must be two independent hold open retention mechanisms (latches).
 - b. At least one egress path obstruction must have a locking feature for at least one hold open retention mechanism.
 - c. Each hold open retention mechanism must be substantiated to applicable static load requirements related to emergency landing conditions, using applicable load safety factor requirements.
 - d. Each hold open retention mechanisms must not retain in a direction opposite to the direction of the emergency landing loads, otherwise the hold open retention mechanisms must be demonstrated to meet the static load requirements with 30% additional load factor.
 - e. The gap between the fully open movable egress path obstruction feature and the latched hold open retention mechanism must be minimized to avoid appreciable inertial dynamic loads.
 - f. One hold open retention mechanism must not be able to be disengaged by the seated, belted occupant of the suite.
8. MOC for SC 8. The Cabin Crew ability to easily and readily check that an egress path obstruction is removed can be substantiated by the obvious removal of the obstruction feature or the latching of the hold open retention mechanism, or other equivalent Means such as a Cabin Crew station deactivation switch of a powered obstruction closing mechanism.
9. MOC for SC 8. If the obstruction feature itself is deployable outside of the suite, it must be demonstrated that it does not impede egress.
10. MOC for SC 8, 9, 10, 11. Training and operating instruction materials must be provided to the operator for incorporation into their Cabin Crew training programs and associated operational manuals as follows
 - a. Information regarding the proper configuration of the egress paths for taxi, takeoff and landing.
 - b. Information regarding abnormal situation, e.g. depressurization, severe turbulence, etc.
 - c. Information regarding firefighting in the suite.
11. MOC for SC 9. The Means of Compliance to demonstrate compliance to this Special Condition requirement of Cabin Crew direct view of the suite area may be one of the following alternatives: a, b, c or d as defined below. Airplane level (and remaining zone) direct view requirements apply to the remainder of the cabin and exclude the suite cabin area. Note that for alternatives c and d, mirrors may be proposed, however the visibility should then be enhanced beyond the minimum requirements outlined in c or d. Also in c or d alternatives, the Means of Compliance of alternative b should still be used for any criteria, which is not deemed specific to the suite situation, i.e. Cabin Crew head movement.
 - a. The Means of Compliance outlined in FAA AC 25.785-1B.
 - b. The Means of Compliance used for the applicable direct view requirements of the passenger cabin, approved prior the installation of the suite.
 - c. The length of each main aisle adjacent to the suite must be visible at least to the point of the entrance area of the last suite enclosure. An aisle is considered visible if at least 50% of the width of the aisle is visible.
 - d. At least 80% of the suite entrances must be visible. An entrance is considered visible, if a person standing in the aisle at the suite entrance is observable, considering a body depth of 12".

12. MOC for SC 10. The effectiveness of the occupant actions and demeanour viewing must be demonstrated for the range of occupant and the range of Cabin Crew, from a 5th percentile female through a 95th percentile male, considering all possible lighting conditions and location of the suite occupant.
13. MOC for SC 11. The usable access of the opening of one egress path obstruction, required when the suite is unoccupied, can be demonstrated by analysis of the usability demonstration of the related unobstructed egress path.
14. MOC for SC 12. Placards to support Cabin Crew duties must ensure that suite occupants are made aware of the following:
 - a. both egress paths and the emergency passage feature,
 - b. method of operation of each egress path obstruction and the emergency passage feature,
 - c. that each egress path obstruction need be removed for taxi, takeoff and landing,
 - d. that at least one egress path obstruction should be left open when the suite is unoccupied.
15. MOC for SC 14. The time for a crewmember on the passenger deck to react to the fire alarm, to don the fire-fighting equipment and to gain access to the suite compartment must not exceed the time for the compartment to become smoke-filled, making it difficult to locate the fire source.
16. MOC for SC 14. Training and procedures must be demonstrated by test, however if the design is such that it is readily apparent by a cabin attendant stepping into the suite where the fire source is located, then firefighting training and procedures need not to be demonstrated by test.
17. MOC for SC 15. The prevention of hazardous condition due to accumulation of excess quantities of smoke and/or extinguishing agent caused by firefighting must be demonstrated for areas outside the suites.

SPECIAL CONDITION and IM	E-02 SC &IM: Fuel Tank Safety
APPLICABILITY:	A380
REQUIREMENTS:	JAR 25.901(c), 25.981, 25.1309, INT/POL/25/12
ADVISORY MATERIAL:	N/A

BACKGROUND

The investigation conducted in the US by the National Transportation Safety Board on the cause of the B747-131 TWA 800 accident determined that the cause was a centre fuel tank explosion arising from an unknown ignition source. In response to various NTSB recommendations, the FAA and JAA have initiated a number of activities related to assessment and improvement of fuel tank safety on current transport category aircraft.

It is apparent from the subsequent investigations that potential ignition sources within fuel tanks arising from system failures or malfunctions may not have been addressed in the past against current understanding of possible failure modes. As the B747 fuel system follows ignition prevention design practices generally similar to most other large transport aircraft, then such lessons learned from these investigations and service history could equally apply to other types. This fact is further supported by the various findings made in service or during inspection, or design review for various aircraft types, including Airbus models.

Regulatory action to address both current and future aircraft fuel system certification standards has been proposed by FAA in the form of an SFAR (ref. NPRM 99-18) but this was not yet in place as of April 20, 2001 (reference date for A380 certification basis determination). Similarly, as a preliminary outcome of related discussions and rulemaking activities, JAA has issued INT/POL/25/12 released on 1st of October 2000.

The JAA certification philosophy is relying primarily on ignition source prevention. However, since the in-service experience on some aircraft models has shown heat released into the fuel system, resulting in an increase of fuel vapour / air mixture temperature into its flammable range, may be a contributor to accidents, the flammability aspects of the issue is also to be considered.

A Special Condition, and associated Interpretative Material, is required to prescribe safety requirements applicable to fuel tanks ignition sources prevention and flammability reduction.

SPECIAL CONDITION

To replace JAR 25.981, with the text proposed below.

25.981 Fuel tank ignition prevention.

- (a) No ignition source may be present at each point in the fuel tank or fuel tank system where catastrophic failure could occur due to ignition of fuel or vapours. This must be shown by:
- (1) Determining the highest temperature allowing a safe margin below the lowest expected auto ignition temperature of the fuel in the fuel tanks.
 - (2) Demonstrating that no temperature at each place inside each fuel tank where fuel ignition is possible will exceed the temperature determined under paragraph (a)(1) of this section. This must be verified under all probable operating, failure, and malfunction conditions of each component whose operation, failure, or malfunction could increase the temperature inside the tank.

(3) Demonstrating that an ignition source does not result from each single failure and from all combinations of failures not shown to be Extremely Improbable as per 25.1309. (See ACJ 25.981(a))

(b) Reserved.

(c) Design precautions must be taken to achieve conditions within the fuel tanks which reduce the likelihood of flammable vapours. (See ACJ 25.981(c)).

INTERPRETATIVE MATERIAL

ACJ 25.981(a)
 Ignition precautions
 See JAR 25.981(a)

1- Introduction

Service history has shown that ignition sources have developed in aircraft fuel tanks due to unforeseen failure modes or factors that may not have been considered at the time of original certification of the aircraft.

2- Background

There are three primary phenomena that can result in ignition of fuel vapours in aeroplane fuel tanks. The first is electrical arcs. The second is friction sparks resulting from mechanical contact of rotating equipment in the fuel tank. The third is hot surface ignition or auto ignition.

The conditions required to ignite fuel vapours from these ignition sources vary with pressures and temperatures within the fuel tank and can be affected by sloshing or spraying of fuel in the tank. Due to the difficulty in predicting fuel tank flammability and eliminating flammable vapours from the fuel tank, design practices have assumed that a flammable fuel air mixture exists in aircraft fuel tanks and require that no ignition sources be present.

Any components located in or adjacent to a fuel tank must be qualified to meet standards that assure, during both normal and failure conditions, ignition of flammable fluid vapours will not occur. This is typically done by a combination of design standards, component testing and analysis. Testing of components to meet explosion proof requirements is carried out for various single and combinations of failures to show that arcing, sparking, auto ignition or flame propagation from the component will not occur. Testing for components has been accomplished using standards and component qualification tests. The standards include for example Eurocae ED-14 / RTCA DO160 and BS 3G 100 that defines explosion proof requirements for electrical equipment and analysis of potential electrical arc and friction sparks.

FUEL SYSTEM IGNITION PREVENTION

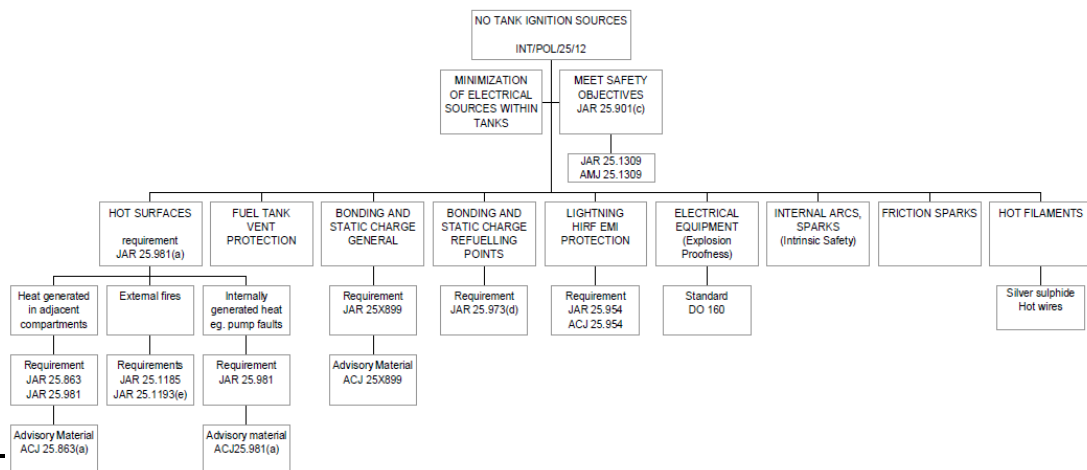

Disclaimer – This document is not exhaustive and it will be updated gradually. An update of this document will not cause an update of the TCDS.

Therefore the focus of this evaluation of the aircraft fuel system should be to identify and address potential sources of ignition within fuel tanks, which may not previously have been considered to be unsafe features.

3- Ignition Sources

3.1 Electrical Arcs and Sparks

Ignition sources from electrical arcs can occur as a result of electrical component and wiring failures, direct and indirect effects of lightning, HIRF / EMI, and static discharges.

The level of electrical energy necessary to ignite fuel vapours is defined in various standards. The generally accepted value is 0.2 millijoules. An adequate margin needs to be considered, when evaluating the maximum allowable energy level for the fuel tank design.

3.2 Friction Sparks

Rubbing of metallic surfaces can create friction spark ignition sources. Typically this may result from debris contacting a fuel pump impeller or an impeller contacting the pump casing.

3.3 Hot Surface Ignition

Guidance provided in AC25-8 has defined hot surfaces which come within 30°C (50°F) of the autogenously ignition temperature of the fuel air mixture for the fluid as ignition sources. It has been accepted that this margin of 30°C supported compliance to JAR 25.981(a). Surface temperatures not exceeding 200°C have been accepted without further substantiation against current fuel types.

4- Lessons learned

4.1 Introduction

As detailed above, the fuel system criticality may not have been addressed in the past against current understanding as far as the ignition risk is concerned. Inspections and design review have been performed, resulting in findings detailed below. One of the main lessons learned is to minimize electrical sources within fuel tanks (see § 4.3).

4.2 Components in-service experience

The following sections intend to present a list of faults, which have occurred to fuel system components. By its nature it cannot be an exhaustive list, but is only attempting to provide a list of undesirable features of fuel system components that should be avoided when designing fuel tanks.

Pumps

- a) Pump inducer failures have occurred resulting in ingestion of the inducer into the pump impeller and release of debris into the fuel tank.
- b) Pump inlet check valves have failed resulting in rubbing on pump impeller.
- c) Stator windings have failed during operation of the fuel pump. Subsequent failure of a second phase of the pump caused arcing through the fuel pump housing.
- d) Thermal protective features incorporated into the windings of pumps have been deactivated by inappropriate wrapping of the windings.
- e) Cooling port tubes have been omitted during pump overhaul.
- f) Extended dry running of fuel pumps in empty fuel tanks, violation of manufacturers recommended procedures, suspected of being causal factors in two incidents.
- g) Use of steel impellers which might produce sparks if debris enters the pump.
- h) Debris has been found lodged inside pumps.
- i) Pump power supply connectors have corroded allowing fuel leakage and electrical arcing.
- j) Electrical connections within the pump housing have been exposed and designed with inadequate clearance from the pump cover resulting in arcing.
- k) Resettable thermal switches resetting at higher trip temperature.
- l) Flame arrestors falling out of their respective mounting.

- m) Internal wires coming in contact with the pump rotating group, energising the rotor and arcing at the impeller / adapter interface.
- n) Poor bonding across component interfaces.
- o) Insufficient ground fault current capability.
- p) Poor bonding of components to structure.
- q) Loads from the aeroplane fuel feed plumbing were transferred.
- r) Premature failure of fuel pump thrust bearings allowing steel rotating parts to contact the steel pump side plate.

Wiring to Pumps located in metallic conduits or adjacent to fuel tank walls.

Wear of Teflon sleeving and wiring insulation allowing arcing to conduit causing an ignition source in tank, or arcing to the tank wall.

Fuel Pump Connectors

Electrical arcing at connections within electrical connectors has occurred due to bent pins or corrosion.

FQIS Wiring

Degradation of wire insulation (cracking) and corrosion (copper sulphate deposits) at electrical connectors, unshielded FQIS wires have been routed in wire bundles with high voltage wires.

FQIS Probes

Corrosion and copper sulphide deposits have caused reduced breakdown voltage in FQIS wiring, FQIS wiring clamping features at electrical connections on fuel probes has caused damage to wiring and reduced breakdown voltage. Contamination in the fuel tanks including: steel wool, lock wire, nuts, rivets, bolts; and mechanical impact damage, caused reduced arc path between FQIS probe walls.

Bonding Straps

Corrosion, inappropriately attached connections (loose or improperly grounded attachment points). Static bonds on fuel system plumbing connections inside the fuel tank have been found corroded or mechanically worn.

Failed or aged seals

Seal deterioration may result in leak internal or external to fuel system, as well as fuel spraying.

4.3 Minimising electrical components hazards within fuel tanks

One of the lessons learned listed above is the undesirable presence of electrical components within fuel tanks. Power wiring has been routed in conduits when crossing fuel tanks, however, chaffing has occurred within conduits. It is therefore suggested that such wiring should be routed outside of fuel tanks to the maximum extent possible. At the equipment level, connectors and adjacent areas should be taken into account during the explosion proofness qualification of the equipment (typically, pumps).

However, for some wiring, such as FQIS or sensor wiring, it might be unavoidable to route them inside of tanks, and therefore they should be qualified as intrinsically safe. The Safety Assessment section below indicates how any residual fuel tank wiring may be shown to meet the required Safety Objectives.

5- Safety assessment

5.1 Introduction

The fuel system must comply with JAR 25.901(c), which requires compliance to JAR 25.1309. According to JAR 25.981(a)(3), the applicant should perform a Safety Assessment of the fuel system showing that the presence of an ignition source within the fuel system is Extremely Improbable and does not result from a single failure, as per JAR 25.1309 and the corresponding AMJ 25.1309 principles.

Advisory Material Joint (AMJ) 25.1309, "System Design and Analysis" describes methods for completing system safety assessments (SSA). The depth and scope of an acceptable SSA depends upon the complexity and criticality of the functions performed by the system under consideration, the severity of related failure conditions, the uniqueness of the design and extent of relevant service experience, the number and complexity of the identified causal failure scenarios, and the ability to detect contributing failures. The SSA criteria, process, analysis methods, validation and documentation should be consistent with the guidance material contained in AMJ 25.1309.

Failure rates of fuel system component should be carefully established as required using in-service experience to the maximum extent.

5.2 Assumptions and Boundary Conditions for the Analysis:

The analysis should be conducted based upon assumptions described in this section.

5.2.a Fuel Tank Flammability

The system safety analysis should be prepared considering all aircraft flight and ground conditions, assuming that an explosive fuel air mixture is present in the fuel tanks at all times.

5.2.b Failure Condition Classification

Unless design features are incorporated that mitigate the hazards resulting from a fuel tank ignition event, (e.g. polyurethane foam), the SSA should assume that the presence of an ignition source is a catastrophic failure condition.

5.2.c Failure conditions

The analysis should be conducted assuming deficiencies and anomalies, failure modes identified by the review of service information on other products as far as practical, and any other failure modes identified by the fuel tank system functional hazard assessment. The effects of manufacturing variability, ageing, wear, corrosion, and likely damage should be considered. In service and production functional tests, component acceptance tests and maintenance checks may be used to substantiate the degree to which these states must be considered. In some cases, for example component bonding or ground paths, a degraded state will not be detectable without periodic functional test of the feature. For these features, inspection/test intervals should be established based on previous service experience on equipment installed in the same environment. If previous experience on similar or identical components is not available, shorter initial inspection/test intervals should be established until design maturity can be assured.

Fuel Pumps.

Service experience shows that there have been a significant number of failure modes, which have the capability of creating an ignition source within the tank. Many of these are as the result of single failures, or single failures in combination with latent failures. It should be shown that fuel pumps do not run dry beyond their qualified level. If fuel pumps can be uncovered during normal operation, it is recommended that pumps are shut down automatically and that the shutdown feature is sufficiently robust such that erroneous pump running does not cause a hazard. It is also recommended to consider the inlet design such that the ingestion of FOD is minimized. It is acceptable to uncover pumps when operating under negative "g" conditions.

Fuel Pump Wiring.

Despite precautions to prevent fuel pump wire chafing, arc faults have occurred. For pump wire installations within the tank or adjacent to the tank wall to remain acceptable, additional means must be provided to isolate the electrical supply, in the event of arc faults. The means must be effective in preventing continued arcing to the conduit or the tank wall.

FQIS Wiring.

Although in recent times, constructors have made attempts to segregate FQIS wiring from other aircraft wiring, it is recognised that it is not possible to be confident, at the design stage, that the segregation will remain effective over the whole fleet life. Subsequent aircraft modifications in service may negate the design intentions. To counter this threat to FQIS wiring, additional design precautions should be considered to prevent any unwanted stray currents, from entering the tank. The precautions taken must remain effective, even following anticipated future modifications.

Bonding Schemes.

Service experience has shown that the required Safety Objectives can be met with a redundant bonding scheme incorporating dual electrical paths, with appropriate level of inspection. No definitive advice can be given about the inspection period, but it is expected that the design and qualification of the bonding leads and attachments (or alternative bonding means) will be sufficiently robust, so that frequent inspections will not be needed.

5.2.d External Environment

The severity of the external environmental conditions that should be considered are those established by certification regulations and special conditions (e.g., HIRF, lightning), regardless of the associated probability. For example, the probability of lightning encounter should be assumed to be one.

5.3 Qualitative Safety Assessment

The level of analysis required to show ignition sources will not develop will depend upon the specific design features of the fuel tank system being evaluated. Detailed quantitative analysis should not be necessary if a qualitative safety assessment shows that features incorporated into the fuel tank system design protect against the development of ignition sources within the fuel tank system. For example, if all wiring entering the fuel tanks was shown to have protective features such as separation, shielding or surge suppressors, the compliance demonstration would be limited to demonstrating the effectiveness of the features and defining any long term maintenance requirements so that the protective features are not degraded.

5.4 Component Qualification Review

Qualification of components such as fuel pumps, using the standard specifications has not always accounted for unforeseen failures, wear, or inappropriate overhaul or maintenance. Service experience indicates that the explosion proofness demonstration needs to remain effective under all of the continued operating conditions likely to be encountered in service. Therefore an extensive evaluation of the qualification of components may be required if qualitative assessment does not limit the component as a potential ignition source.

5.5 Electrical sparks

The Applicant should perform a failure analysis of all fuel systems and sub systems with wiring routed into fuel tanks. Systems that should be considered include, temperature indication, Fuel Quantity Indication System, Fuel Level sensors, fuel pump power and control and indication, and any other wiring routed into or adjacent to fuel tanks. The analysis must consider system level failures and also component level failures mentioned in Section 4.2 and discussed below. Component failures, which have been experienced in service, are to be considered as probable,

single failures. The analysis should include existence of latent failures, such as contamination, damage/pinching of wires during installation or corrosion on the probes, connectors, or wiring and subsequent failures that may lead to an ignition source within the fuel tank. The wire routing, shielding and segregation outside the fuel tanks should also be considered. The evaluation must consider both electrical arcing and localised heating that may result on equipment, fuel quantity indicating system probes, and wiring.

5.5.a Electrical Short Circuits

5.5.a.1 Effects of electrical short circuits, including hot shorts, on equipment and wiring which enter the fuel tanks should be considered, particularly for the fuel quantity indicating system wiring, fuel level sensors and probes.

5.5.a.2 The evaluation of electrical short circuits must consider shorts within electrical equipment.

5.5.b Electromagnetic Effects, including Lightning, EMI, and HIRF

5.5.b.1 Effects of electrical transients from lightning, EMI or HIRF on equipment and wiring within the fuel tanks should be considered, particularly for the fuel quantity indicating system wiring and probes.

5.5.b.2 Latent failures such as shield and termination corrosion, shield damage, and transient limiting device failure should be considered and appropriate indication or inspection intervals established.

5.5.b.3 The evaluation of electromagnetic effects from lightning, EMI, or HIRF must be based on the specific electromagnetic environment of a particular aircraft model. Standardized tests such as those in EUROCAE ED-14/RTCA DO-160 Sections 19, 20 and 22 are not sufficient alone, without evaluation of the characteristics of the specific electromagnetic environment for a particular aircraft model to show that appropriate standardised ED-14/DO-160 test procedures and test levels are selected. Simulation of various latent failures of fuel system components within the tanks may be required to demonstrate the transient protection effectiveness.

5.6 Friction Sparks:

The analysis should include evaluation of the effects of debris entering the fuel pumps, including any debris that could be generated internally such as any components upstream of the pump inlet. Service experience has shown that pump inlet check valves, inducers, nuts, bolts, rivets, fasteners, sealant, lock wire etc. have been induced into fuel pumps and contacted the impeller. This condition could result in creation of friction sparks and should be considered as part of the system assessment when conducting the system safety assessment.

6- Instructions for continued airworthiness for the fuel tank system

The analysis conducted to show compliance with JAR 25.981(a) may result in the need to define certain required inspection or maintenance items. Any item that is required to assure that an ignition source does not develop within the fuel tank or maintain protective features incorporated to preclude a catastrophic fuel tank ignition event must be incorporated in the limitations section of the instructions for continued airworthiness or in the maintenance program.

ACJ 25.981(c)

Flammability precautions

See JAR 25.981(c)

The intention of this requirement is to introduce design precautions, to avoid unnecessary increases in fuel tank flammability. These precautions should ensure:

- (i) no large net heat sources going into the tank,
- (ii) no unnecessary spraying, sloshing or creation of fuel mist.

– END –

SPECIAL CONDITION and IM	E-04 SC &IM: Thrust reverser system
APPLICABILITY:	A380
REQUIREMENTS:	JAR 25.901, 25.933(a)
ADVISORY MATERIAL:	TGM/25/01

BACKGROUND

The in-service experience on thrust reverser systems in the past years has led Authorities to reconsider the Means of Compliance used in the past to show compliance to JAR 25.933(a). The controllability demonstration as traditionally required by JAR 25.933(a) has shown it had some severe shortcomings, since it heavily relied on crew response, training, and operational conditions. On the other hand, the reliability option (i.e. showing the thrust reverser deployment in-flight is extremely improbable) requires a very rigorous safety assessment methodology to show the integrity of thrust reverser systems, due to the very stringent, harsh environment, as well as operating and maintenance conditions generally placed upon those systems. Specifically, latent failures and dispatch conditions need to be carefully considered.

Therefore, in accordance with JAR 21.16(a)(3), it was proposed to replace JAR 25.933(a) by the following Special Condition, completed by the Interpretative Material, based on the advisory material proposed by the Powerplant Harmonization Working Group (ref. minutes of the 20th PPIHWG meeting, Cannes, France, - 933 Task Team - Thrust Reverser Harmonization, FAR/JAR 25.933 draft rule and advisory material draft 10, phase II) in order to enforce the desired safety level.

SPECIAL CONDITION

§ 25.933 Reversing systems.

(a) For turbojet reversing systems

(1) Each system intended for ground operation only must be designed so that either

- (i) The airplane can be shown to be capable of continued safe flight and landing during and after any thrust reversal in flight; or
- (ii) It can be demonstrated that inflight thrust reversal is extremely improbable and does not result from a single failure or malfunction.

INTERPRETATIVE MATERIAL

ACJ 25.933(a)(1)

Unwanted in-flight thrust reversal of turbojet thrust reversers

See JAR 25.933(a)(1)

1. PURPOSE.

This Advisory Circular - Joint (ACJ) describes various acceptable means, for showing compliance with the requirements of JAR 25.933(a)(1), "Reversing systems", of JAR-25.

These means are intended to provide guidance to supplement the engineering and operational judgement that must form the basis of any compliance findings relative to inflight thrust reversal of turbojet thrust reversers.

2. RELATED JAR SECTIONS.

JAR 25.111, 25.143, 25.251, 25.571, 25.901, 25.903, 25.1155, 25.1305, 25.1309, 25.1322 and 25.1529.

3. APPLICABILITY.

The requirements of JAR 25.933 apply to turbojet thrust reverser systems. JAR 25.933(a) specifically applies to reversers intended for ground operation only, while JAR 25.933(b) applies to reversers intended for both ground and inflight use.

This ACJ applies only to unwanted thrust reversal in flight phases when the landing gear is not in contact with the ground; other phases (i.e., ground operation) are addressed by JAR 25.901(c) and JAR 25.1309.

4. BACKGROUND.

4.a General. Most thrust reversers are intended for ground operation only. Consequently, thrust reverser systems are generally sized and developed to provide high deceleration forces while avoiding foreign object debris (FOD) ingestion, aeroplane surface efflux impingement, and aeroplane handling difficulty during landing roll. Likewise, aircraft flight systems are generally sized and developed to provide lateral and directional controllability margins adequate for handling qualities, manoeuvrability requirements, and engine-out VMC lateral drift conditions. In early turbojet aeroplane designs, the combination of control system design and thrust reverser characteristics resulted in control margins that were capable of recovering from unwanted inflight thrust reversal even on ground-use-only reversers; this was required by the previous versions of JAR 25.933.

As the predominant large aeroplane configuration has developed into the high bypass ratio twin engine-powered model, control margins for the inflight thrust reversal case have decreased. Clearly, whenever and wherever thrust reversal is intended, the focus must remain on limiting any adverse effects of thrust reversal. However, when demonstrating compliance with JAR 25.933(a) or 25.933(b), the Authority has accepted that applicants may either provide assurance that the aeroplane is controllable after an inflight thrust reversal event or that the unwanted inflight thrust reversal event will not occur.

Different historical forms of the rule have attempted to limit either the effect or the likelihood of unwanted thrust reversal during flight. However, experience has demonstrated that neither method is always both practical and effective. The current rule, and this related advisory material, are intended to allow either of these assurance methods to be applied in a manner which recognises the limitations of each, thereby maximising both the design flexibility and safety provided by compliance with the rule.

4.b. Minimising Adverse Effects. The primary purpose of reversing systems, especially those intended for ground operation only, is to assist in decelerating the aeroplane during landing and during an aborted take-off. As such, the reverser must be rapid-acting and must be effective in producing sufficient reverse thrust. These requirements result in design characteristics (actuator sizing, efflux characteristics, reverse thrust levels, etc.) that, in the event of thrust during flight, could cause significant adverse effects on aeroplane controllability and performance.

If the effect of the thrust reversal occurring in flight produces an unacceptable risk to continued safe flight and landing, then the reverser operation and de-activation system must be designed to prevent unwanted thrust reversal. Alternatively, for certain aeroplane configurations, it may be possible to limit the adverse impacts of unwanted thrust reversal on aeroplane controllability and performance such that the risk to continued safe flight and landing is acceptable (discussed later in this ACJ).

For reversing systems intended for operation in flight, the reverser system must be designed to adequately protect against unwanted inflight thrust reversal.

JAR 25.1309 and 25.901(c) and the associated AMJ and ACJ (AMJ 25.1309-1 and ACJ 25.901(c) provide guidance for developing and accessing the safety of systems at the design stage. This methodology should be applied to the total reverser system, which includes:

- the reverser;

- the engine (if it can contribute to thrust reversal);
- the reverser motive power source;
- the reverser control system;
- the reverser command system in the cockpit; and
- the wiring, cable, or linkage system between the cockpit and engine.

Approved removal, deactivation, reinstallation, and repair procedures for any element in the reverser or related systems should result in a safety level equivalent to the certified baseline system configuration.

Qualitative assessments should be done, taking into account potential human errors (maintenance, aeroplane operation).

Data required to determine the level of the hazard to the aeroplane in case of inflight thrust reversal and, conversely, data necessary to define changes to the reverser or the aeroplane to eliminate the hazard, can be obtained from service experience, test, and/or analysis. These data also can be used to define the envelope for continued safe flight.

There are many opportunities during the design of an aeroplane to minimise both the likelihood and severity of unwanted inflight thrust reversal. These opportunities include design features of both the aeroplane and the engine/reverser system. During the design process, consideration should be given to the existing stability and control design features, while preserving the intended function of the thrust reverser system.

Some design considerations, which may help reduce the risk from inflight thrust reversal, include:

- 4.b.(1) Engine location to:
 - 4.b.(1)(a) Reduce sensitivity to efflux impingement.
 - 4.b.(1)(b) Reduce effective reverse thrust moment arms
- 4.b.(2) Engine/Reverser System design to:
 - 4.b.(2)(a) Optimise engine/reverser system integrity and reliability.
 - 4.b.(2)(b) Rapidly reduce engine airflow (i.e. auto-idle) in the event of an unwanted thrust reversal. Generally, such a feature is considered a beneficial safety item. In this case, the probability and effect of any unwanted idle command or failure to provide adequate reverse thrust when selected should be verified to be consistent with AMJ 25.1309-1 and ACJ 25.901(c).
 - 4.b.(2)(c) Give consideration to the aeroplane pitch, yaw, and roll characteristics.
 - 4.b.(2)(d) Consider effective efflux diameter.
 - 4.b.(2)(e) Consider efflux area.
 - 4.b.(2)(f) Direct reverser efflux away from critical areas of the aeroplane.
 - 4.b.(2)(g) Expedite detection of unwanted thrust reversal, and provide for rapid compensating action within the reversing system.
 - 4.b.(2)(h) Optimise positive aerodynamic stowing forces.
 - 4.b.(2)(i) Inhibit inflight thrust reversal of ground-use-only reversers, even if commanded by the flight crew.
 - 4.b.(2)(j) Consider incorporation of a restow capability for unwanted thrust reversal.
- 4.b.(3) Airframe/System design to:
 - 4.b.(3)(a) Maximise aerodynamic control capability.
 - 4.b.(3)(b) Expedite detection of thrust reversal, and provide for rapid compensating action through other airframe systems.
 - 4.b.(3)(c) Consider crew procedures and responses.

The use of formal «lessons learned»-based reviews early and often during design development may help avoid repeating previous errors and take advantage of previous successes.

5.

DEFINITIONS.

The following definitions apply for the purpose of this ACJ :

5.a. Catastrophic: see AMJ 25.1309-1

5.b. Continued Safe Flight and Landing: The capability for continued controlled flight and safe landing at an airport, possibly using emergency procedures, but without requiring exceptional pilot skill or strength. Some aeroplane damage may be associated with a failure condition, during flight or upon landing.

5.c. Controllable Flight Envelope and Procedure: An area of the Normal Flight Envelope where, given an appropriate procedure, the aeroplane is capable of continued safe flight and landing following an inflight thrust reversal.

5.d. Deactivated Reverser: Any thrust reverser that has been deliberately inhibited such that it is precluded from performing a normal deploy/stow cycle, even if commanded to do so.

5.e. Exceptional Piloting Skill and/or Strength: Refer to JAR 25.143(c) («Controllability and Manoeuvrability—General») and AC 25-7 («Flight Test Guide»).

5.f. Extremely Improbable: see AMJ 25.1309-1

5.g. Extremely Remote: see AMJ 25.1309-1

5.h. Failure: see AMJ 25.1309-1

5.i. Failure Situation: All failures that result in the malfunction of one independent command and/or restraint feature that directly contributes to the top level Fault Tree Analysis event (i.e., unwanted inflight thrust reversal). For the purpose of illustration, Figure 1, below, provides a fault tree example for a scenario of three «failure situations» leading to unwanted inflight thrust reversal.

Figure 1:
TOP EVENT

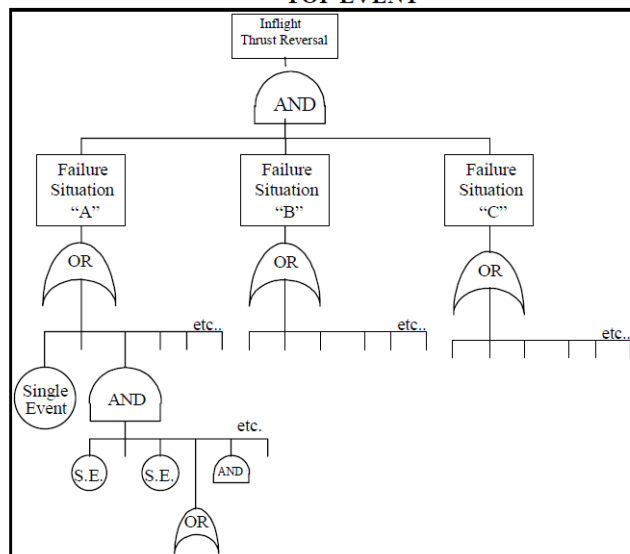

Reverser System with three independant command/restraint features shown for reference only.

5.j. Hazardous: see AMJ 25.1309-1.

5.k. Inflight: that part of aeroplane operation beginning when the wheels are no longer in contact with the ground during the takeoff and ending when the wheels again contact the ground during landing.

5.l. Light Crosswind: For purposes of this AC, a light crosswind is a 10 Kt. wind at right angles to the direction of takeoff or landing which is assumed to occur on every flight.

5.m. Light Turbulence: Turbulence that momentarily causes slight, erratic changes in altitude and/or attitude (pitch, roll, and/or yaw), which is assumed to occur on every flight.

5.n. Major: see AMJ 25.1309-1

5.o. Maximum exposure time: The longest anticipated period between the occurrence altitude, angle of attack, attitude) associated with the practical and routine operation of a specific

aeroplane that is likely to be encountered on a typical flight and in combination with prescribed conditions of light turbulence and light crosswind.

5.p. Pre-existing failure: Failure that can be present for more than one flight.

5.q. Thrust Reversal: A movement of all or part of the thrust reverser from the forward thrust position to a position that spoils or redirects the engine airflow.

5.r. Thrust Reverser System: Those components that spoil or redirect the engine thrust to decelerate the aeroplane. The components include:

- the engine-mounted hardware,
- the reverser control system,
- indication and actuation systems, and
- any other aeroplane systems that have an effect on the thrust reverser operation.

5.s. Turbojet thrust reversing system: Any device that redirects the airflow momentum from a turbojet engine so as to create reverse thrust. Systems may include:

- cascade-type reversers,
- target or clamshell-type reversers,
- pivoted-door petal-type reversers,
- deflectors articulated off either the engine cowling or aeroplane structure,
- targetable thrust nozzles, or
- a propulsive fan stage with reversing pitch.

5.t. Turbojet (or turbofan): A gas turbine engine in which propulsive thrust is developed by the reaction of gases being directed through a nozzle.

6. DEMONSTRATING COMPLIANCE WITH JAR 25.933(a).

The following Sections 7 through 10 of this ACJ provide guidance on specific aspects of compliance with JAR 25.933(a), according to four different means or methods:

- Controllability (Section 7),
- Reliability (Section 8),
- Mixed controllability / reliability (Section 9),
- Deactivated reverser (Section 10).

7. «CONTROLLABILITY OPTION»: PROVIDE CONTINUED SAFE FLIGHT AND LANDING FOLLOWING ANY INFLIGHT THRUST REVERSAL.

The following paragraphs provide guidance regarding an acceptable means of demonstrating compliance with JAR 25.933(a)(1).

7.a. General. For compliance to be established with JAR 25.933(a) by demonstrating that the aeroplane is capable of continued safe flight and landing following any inflight thrust reversal (the «controllability option» provided for under JAR 25.933(a)(1)), the aspects of structural integrity, performance, and handling qualities must be taken into account. The level of accountability should be appropriate to the probability of inflight thrust reversal, in accordance with the following sections.

To identify the corresponding failure conditions and determine the probability of their occurrence, a safety analysis should be carried out, using the methodology described in JAR 25.1309. The reliability of design features, such as auto-idle and automatic control configurations critical to meeting the following controllability criteria, also should be considered in the safety analysis.

Appropriate alerts and/or other indications should be provided to the crew, as required by JAR 25.1309(c) (Ref. AMJ 25.1309-1).

The inhibition of alerts relating to the thrust reverser system during critical phases of flight should be evaluated in relation to the total effect on flight safety (Ref. AMJ 25.1309-1).

Thrust reversal of a cyclic or erratic nature (e.g., repeated deploy/stow movement of the thrust reverser) should be considered in the safety analysis and in the design of the alerting/indication systems.

Input from the flight crew and human factors specialists should be considered in the design of the alerting and/or indication provisions.

The controllability compliance analysis should include the relevant thrust reversal scenario that could be induced by a rotor burst event.

When demonstrating compliance using this «controllability option» approach, if the aeroplane might experience an inflight thrust reversal outside the «controllable flight envelope» anytime during the entire operational life of all aeroplanes of this type, then further compliance considerations as described in Section 9 («MIXED CONTROLLABILITY / RELIABILITY OPTION») of this ACJ, below, should be taken into account.

7.b. Structural Integrity. For the «controllability option», the aeroplane must be capable of successfully completing a flight during which an unwanted inflight thrust reversal occurs.

An assessment of the integrity of the aeroplane structure is necessary, including an assessment of the structure of the deployed thrust reverser and its attachments to the aeroplane.

In conducting this assessment, the normal structural loads, as well as those induced by failures and forced vibration (including buffeting), both at the time of the event and for continuation of the flight, must be shown to be within the structural capability of the aeroplane.

At the time of occurrence, starting from 1-g level flight conditions, at speeds up to VC, a realistic scenario, including pilot corrective actions, should be established to determine the loads occurring at the time of the event and during the recovery manoeuvre. The aeroplane should be able to withstand these loads multiplied by an appropriate factor of safety that is related to the probability of unwanted inflight thrust reversal. The factor of safety is defined in Figure 2, below. Conditions with high lift devices deployed also should be considered at speeds up to the appropriate flap limitation speed.

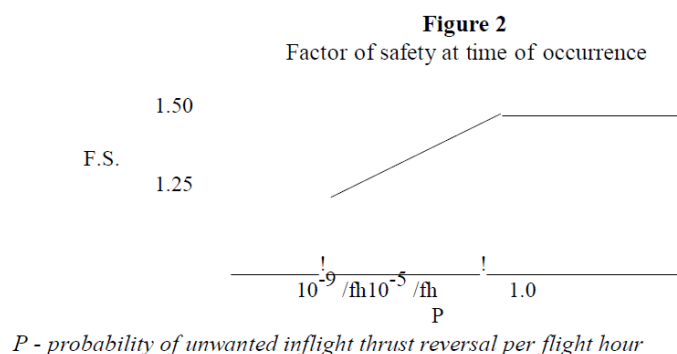

For continuation of the flight following inflight thrust reversal, considering any appropriate reconfiguration and flight limitations, the following apply:

7.b.(1) Static strength should be determined for loads derived from the following conditions at speeds up to VC, or the speed limitation prescribed for the remainder of the flight:

7.b.(1)(a) 70% of the limit flight manoeuvre loads; and separately

7.b.(1)(b) the discrete gust conditions specified in JAR 25.341(a) (but using 40% of the gust velocities specified for VC).

7.b.(2) For the aeroplane with high lift devices deployed, static strength should be determined for loads derived from the following conditions at speeds up to the appropriate flap design speed, or any lower flap speed limitation prescribed for the remainder of the flight:

7.b.(2)(a) A balanced manoeuvre at a positive limit load factor of 1.4; and separately

7.b.(2)(b) the discrete gust conditions specified in JAR 25.345(a)(2) (but using 40% of the gust velocities specified).

7.b.(3) For static strength substantiation, each part of the structure must be able to withstand the loads specified in sub-paragraph 7.b.(1) and 7.b.(2) of this paragraph, multiplied by a factor of safety depending on the probability of being in this failure state.

The factor of safety is defined in Figure 3, below.

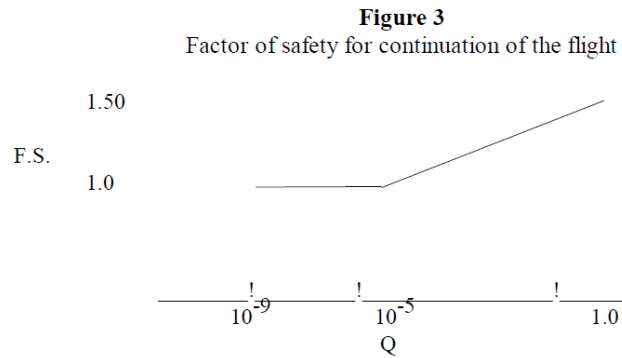

Q - is the probability of being in the configuration with the unwanted inflight thrust reversal

$Q = (T)(P)$ where:

T = average time spent with unwanted inflight thrust reversal (in hours)

P = probability of occurrence of unwanted inflight thrust reversal (per hour)

If the thrust reverser system is capable of being restowed following a thrust reversal, only those loads associated with the interval of thrust reversal need to be considered. Historically, thrust reversers have often been damaged as a result of unwanted thrust reversal during flight. Consequently, any claim that the thrust reverser is capable of being restowed must be adequately substantiated, taking into account this adverse service history.

7.c. Performance

7.c.(1) General Considerations: Most failure conditions that have an effect on performance are adequately accounted for by the requirements addressing a «regular» engine failure (i.e., involving only loss of thrust and not experiencing any reverser anomaly). This is unlikely to be the case for failures involving an unwanted inflight thrust reversal, which can be expected to have a more adverse impact on thrust and drag than a regular engine failure. Such unwanted inflight thrust reversals, therefore, should be accounted for specifically, to a level commensurate with their probability of occurrence.

The performance accountability that should be provided is defined in Sections 7.c.(2) and 7.c.(3) as a function of the probability of the unwanted inflight thrust reversal.

Obviously, for unwanted inflight thrust reversals less probable than 1 E-9/fh, certification may be based on reliability alone, as described in Section 8 («RELIABILITY OPTION») of this ACJ. Furthermore, for any failure conditions where unwanted inflight thrust reversal would impact safety, the aeroplane must meet the safety/reliability criteria delineated in JAR 25.1309.

7.c.(2) *Probability of unwanted inflight thrust reversal greater than 1 E-7/fh*: Full performance accountability must be provided for the more critical of a regular engine failure and an unwanted inflight thrust reversal.

To determine if the unwanted inflight thrust reversal is more critical than a regular engine failure, the normal application of the performance requirements described in JAR-25, Subpart B, as well as the applicable operating requirements, should be compared to the application of the following criteria, which replace the accountability for a critical engine failure with that of a critical unwanted inflight thrust reversal:

- JAR 25.111, «Take-off path»: The take-off path should be determined with the critical unwanted thrust reversal occurring at VLOF instead of the critical engine failure at VEF. No change to the state of the engine with the thrust reversal that requires action by the pilot may be made until the aircraft is 400 ft above the take-off surface.
- JAR 25.121, «Climb: one-engine-inoperative»: Compliance with the one-engine inoperative climb gradients should be shown with the critical unwanted inflight thrust reversal rather than the critical engine inoperative.

- JAR 25.123, «En-route flight paths»: The en-route flight paths should be determined following occurrence of the critical unwanted inflight thrust reversal(s) instead of the critical engine failure(s), and allowing for the execution of appropriate crew procedures. For compliance with the applicable operating rules, an unwanted inflight thrust reversal(s) at the most critical point en-route should be substituted for the engine failure at the most critical point en-route.

Performance data determined in accordance with these provisions, where critical, should be furnished in the Aeroplane Flight Manual as operating limitations.

Operational data and advisory data related to fuel consumption and range should be provided for the critical unwanted inflight thrust reversal to assist the crew in decision making. These data may be supplied as simple factors or additives to apply to normal all-engines-operating fuel consumption and range data. For approvals to conduct extended range operations with two-engine aeroplanes (ETOPS), the critical unwanted inflight thrust reversal should be considered in the critical fuel scenario [paragraph 10d(4)(iii) of Information Leaflet no. 20 : ETOPS].

7.c.(3) Probability of unwanted inflight thrust reversal equal to or less than 1 E-7/fh, but greater than 1 E-9/fh: With the exception of the take-off phase of flight, which needs not account for unwanted inflight thrust reversal, the same criteria should be applied as in Section 7.c.(2), above, for the purposes of providing advisory data and procedures to the flight crew. Such performance data, however, need not be applied as operating limitations. The take-off data addressed by Section 7.c.(2), above (take-off speeds, if limited by VMC, take-off path, and take-off climb gradients), does not need to be provided, as it would be of only limited usefulness if not applied as a dispatch limitation.

However, the take-off data should be determined and applied as operating limitations if the unwanted inflight thrust reversal during the take-off phase is the result of a single failure.

As part of this assessment, the effect of an unwanted inflight thrust reversal on approach climb performance, and the ability to execute a go-around manoeuvre should be determined and used to specify crew procedures for an approach and landing following a thrust reversal. For example, the procedures may specify the use of a flap setting less than that specified for landing, or an airspeed greater than the stabilised final approach airspeed, until the flight crew is satisfied that a landing is assured and a go-around capability need no longer be maintained.

Allowance may be assumed for execution of appropriate crew procedures subsequent to the unwanted thrust reversal having occurred. Where a number of thrust reversal states may occur, these procedures for approach and landing may, at the option of the applicant, be determined either for the critical thrust reversal state or for each thrust reversal state that is clearly distinguishable by the flight crew.

Operational data and advice related to fuel consumption and range should be provided for the critical unwanted inflight thrust reversal to assist the crew in decision-making. These data may be supplied as simple factors or additives to apply to normal all-engines-operating fuel consumption and range data.

7.d. Handling Qualities

7.d.(1) Probability of unwanted inflight thrust reversal greater than 1 E-7/fh : The more critical of an engine failure [or flight with engine(s) inoperative], and an unwanted inflight thrust reversal, should be used to show compliance with the controllability and trim requirements of JAR-25, Subpart B. In addition, the criteria defined in Section 7.d.(2), below, also should be applied. To determine if the unwanted inflight thrust reversal is more critical than an engine failure, the normal application of the JAR-25, Subpart B, controllability and trim requirements should be compared to the application of the following criteria, which replace the accountability for a critical engine failure with that of a critical unwanted inflight thrust reversal:

- JAR 25.143, «Controllability and Manoeuvrability - General» : the effect of a sudden unwanted inflight thrust reversal of the critical engine, rather than the sudden failure of the critical engine, should be evaluated in accordance with JAR25.143(b)(1) and the associated guidance material.

- Control forces associated with the failure should comply with JAR 25.143(c).
- JAR 25.147, «Directional and lateral control» : the requirements of JAR 25.147(a), (b), (c), and (d) should be complied with following critical unwanted inflight thrust reversal(s) rather than with one or more engines inoperative.
 - JAR 25.149, «Minimum control speed»: the values of VMC and VMCL should be determined with a sudden unwanted inflight thrust reversal of the critical engine rather than a sudden failure of the critical engine.
 - JAR 25.161, «Trim» the trim requirements of JAR 25.161(d) and (e) should be complied with following critical unwanted inflight thrust reversal(s), rather than with one or more engines inoperative.

Compliance with these requirements should be demonstrated by flight test. Simulation or analysis will not normally be an acceptable means of compliance for such probable failures.

7.d.(2) *Probability of unwanted thrust reversal equal to or less than 1 E-7/fh, but greater than 1 E-9/fh*: failure conditions with a probability equal to or less than 1 E-7/fh are not normally evaluated against the specific controllability and trim requirements of JAR-25, Subpart B.

Instead, the effects of unwanted inflight thrust reversal should be evaluated on the basis of maintaining the capability for continued safe flight and landing, taking into account pilot recognition and reaction time. One exception is that the minimum control speed requirement of JAR 25.149 should be evaluated to the extent necessary to support the performance criteria specified in Section 7.c.(3), above, related to approach, landing, and go-around.

Recognition of the failure may be through the behaviour of the aircraft or an appropriate failure alerting system, and the recognition time should not be less than one second.

Following recognition, additional pilot reaction times should be taken into account, prior to any corrective pilot actions, as follows:

- Landing : no additional delay
- Approach : 1 second
- Climb, cruise, and descent : 3 seconds; except when in auto-pilot engaged manoeuvring flight, or in manual flight, when 1 second should apply.

Both auto-pilot engaged and manual flight should be considered.

The unwanted inflight thrust reversal should not result in any of the following:

- exceedance of an airspeed halfway between VMO and VDF, or Mach Number halfway between MMO and MDF.
- a stall.
- a normal acceleration less than a value of 0g.
- bank angles of more than 60° en-route, or more than 30° below a height of 1000 ft.
- degradation of flying qualities assessed as greater than Major for unwanted inflight thrust reversal more probable than 1 E-7/fh; or assessed as greater than Hazardous for failures with a probability equal to or less than 1 E-7/fh, but greater 1 E-9/fh
- the roll control forces specified in JAR 25.143(c), except that the long term roll control force should not exceed 10 lb.
- Structural loads in excess of those specified in Section 7.b., above.

Demonstrations of compliance may be by flight test, by simulation, or by analysis suitably validated by flight test or other data.

7.d.(3) *Probability of inflight thrust reversal less than 1 E-9/fh*: Certification can be based on reliability alone as described in Section 8, below.

8. «RELIABILITY OPTION»: PROVIDE CONTINUED SAFE FLIGHT AND LANDING BY PREVENTING ANY INFLIGHT THRUST REVERSAL

The following paragraphs provide guidance regarding an acceptable means of demonstrating compliance with JAR 25.933(a)(2).

8.a. General. For compliance to be established with JAR 25.933(a) by demonstrating that unwanted inflight thrust reversal is not anticipated to occur (the «reliability option» provided for under JAR 25.933(a)(2)), the aspects of system reliability, maintainability, and fault tolerance; structural integrity; and protection against zonal threats such as uncontained engine rotor failure or fire must be taken into account.

8.b. System Safety Assessment (SSA): Any demonstration of compliance should include an assessment of the thrust reverser control, indication and actuation system(s), including all interfacing power-plant and aeroplane systems (such as electrical supply, hydraulic supply, flight/ground status signals, thrust lever position signals, etc.) and maintenance.

The reliability assessment should include:

- the possible modes of normal operation and of failure;
- the resulting effect on the aeroplane considering the phase of flight and operating conditions;
- the crew awareness of the failure conditions and the corrective action required;
- failure detection capabilities and maintenance procedures, etc.; and
- the likelihood of the failure condition.

Consideration should be given to failure conditions being accompanied or caused by external events or errors.

The SSA should be used to identify critical failure paths for the purpose of conducting in-depth validation of their supporting failure mode, failure rates, exposure time, reliance on redundant subsystems, and assumptions, if any. In addition, the SSA can be used to determine acceptable time intervals for any required maintenance intervals (ref. AMJ 25.1309-1 and AMJ 25.19).

The primary intent of this approach to compliance is to improve safety by promoting more reliable designs and better maintenance, including minimising pre-existing faults. However, it also recognises that flexibility of design and maintenance are necessary for practical application.

8.b.(1) The thrust reverser system should be designed so that any inflight thrust reversal that is not shown to be controllable in accordance with Section 7, above, is extremely improbable (i.e., average probability per hour of flight of the order of $1 \text{ E-}9/\text{fh}$. or less) and does not result from a single failure or malfunction. And 8.b.(2) For configurations in which combinations of two-failure situations (ref. Section 5, above) result in inflight thrust reversal, the following apply: Neither failure may be pre-existing (i.e., neither failure situation can be undetected or exist for more than one flight); the means of failure detection must be appropriate in consideration of the monitoring device reliability, inspection intervals, and procedures.

- The occurrence of either failure should result in appropriate cockpit indication or be self-evident to the crew to enable the crew to take necessary actions such as discontinuing a take-off, going to a controllable flight envelope en-route, diverting to a suitable airport, or reconfiguring the system in order to recover single failure tolerance, etc. And

8.b.(3) For configurations in which combinations of three or more failure situations result in inflight thrust reversal, the following applies:

- In order to limit the exposure to pre-existing failure situations, the maximum time each pre-existing failure situation is expected to be present should be related to the frequency with which the failure situation is anticipated to occur, such that their product is on the order of $1 \text{ E-}3$ or less.
- The time each failure situation is expected to be present should take into account the expected delays in detection, isolation, and repair of the causal failures.

8.c. Structural Aspects: For the «reliability option,» those structural load paths that affect thrust reversal should be shown to comply with the static strength, fatigue, damage tolerance, and deformation requirements of JAR-25. This will ensure that unwanted inflight thrust reversal is not anticipated to occur due to failure of a structural load path, or due to loss of retention under ultimate load throughout the operational life of the aeroplane.

8.d. Uncontained Rotor Failure: In case of rotor failure, compliance with JAR 25.903(d)(1) should be shown, using advisory materials (AC, user manual, etc.) supplemented by the methods described below. The effects of associated loads and vibration on the reverser system should be considered in all of the following methods of minimising hazards:

8.d.(1) Show that engine spool-down characteristics or potential reverser damage are such that compliance with Section 7, above, can be shown.

8.d.(2) Show that forces that keep the thrust reverser in stable stowed position during and after the rotor burst event are adequate.

8.d.(3) Locate the thrust reverser outside the rotor burst zone.

8.d.(4) Protection of thrust reverser restraint devices: The following guidance material describes methods of minimising the hazard to thrust reverser stow position restraint devices located within rotorburst zones. The following guidance material has been developed on the basis of all of the data available to date and engineering judgement.

8.d.(4)(a) Fragment Hazard Model:

8.d.(4)(a)(i) Large Fragments

- Ring Disks (see **Figure 4.a.**) - Compressor drum rotors or spools with ring disks have typically failed in a rim peeling mode when failure origins are in the rim area. This type of failure typically produces uncontained fragment energies, which are mitigated by a single layer of conventional aluminium honeycomb structure. (Note: This guidance material is based upon field experience and, as such, its application should be limited to aluminium sheet and honeycomb fan reverser construction. Typical construction consists of a half inch (12.7 mm) **thickness of .003-.004 aluminium foil honeycomb with .030" thick aluminium facing sheets.** Alternative materials and methods of construction should have at least equivalent impact energy absorption characteristics). Failures with the origins in the bore of these same drum sections have resulted in fragments which can be characterised as a single 1/3 disk fragment and multiple smaller fragments.

The 1/3 disk fragment may or may not be contained by the thrust reverser structure. The remaining intermediate and small disk fragments, while escaping the engine case, have been contained by the thrust reverser structure.

- Deep Bore Disks (see Figure 4.b.) and Single Disks (see Figure 4.c.) – For compressor drum rotors or spools with deep bore disks, and single compressor and turbine disks, the experience, while limited, indicates either a 1/3 and a 2/3 fragment, or a 1/3 fragment and multiple intermediate and small discrete fragments should be considered. These fragments can be randomly released within an impact area that ranges ± 5 degrees from the plane of rotation.

8.d.(4)(a)(ii) Small Fragments (Debris): Consider small fragments (reference AMJ 20-128A, paragraph 9.d.) that could impact the thrust reverser at + 15 degrees axial spread angle.

8.d.(4)(b) Minimisation: Minimisation guidance provided below is for fragments from axial flow rotors surrounded by fan flow thrust reversers located over the intermediate or high pressure core rotors.

NOTE: See attached Figure 5: Typical High Bypass Turbofan Low and High Pressure Compressor with Fan Thrust Reverser Cross Section.

8.d.(4)(b)(i) Large Fragments: For the large fragments defined in Section 8.d.(4)(a)(i), above, the thrust reverser retention systems should be redundant and separated as follows:

- Ring Disks Compressor Spools: Retention systems located in the outer barrel section of the thrust reverser should be separated circumferentially (circumferential distance greater than the 1/3 disk fragment model as described in AMJ 20-128A) or axially (outside the ± 5 degree impact area) so that a 1/3 disk segment cannot damage all redundant retention elements and allow thrust reversal (i.e., deployment of a door or translating reverser sleeve

half). Retention systems located between the inner fan flow path wall and the engine casing should be located axially outside the + 5 degree impact area.

- Deep-bore Disk Spools and Single Disks: Retention systems should be separated axially with at least one retention element located outside the ± 5 degree impact area.

8.d.(4)(b)(ii) Small Fragments: For the small fragments defined in Section 8.d.(4)(a)(ii), above, thrust reverser retention systems should be provided with either:

- At least one retention element shielded in accordance with AMJ 20-128A, paragraph 7(c), or capable of maintaining its retention capabilities after impact; or
- One retention element located outside the ± 15 degree impact area.

9. «MIXED CONTROLLABILITY / RELIABILITY» OPTION.

If the aeroplane might experience an unwanted inflight thrust reversal outside the «controllable flight envelope» anytime during the entire operational life of all aeroplanes of this type, then outside the controllable envelope reliability compliance must be shown, taking into account associated risk exposure time and the other considerations described in Section 8, above.

Conversely, if reliability compliance is selected to be shown within a given limited flight envelope with associated risk exposure time, then outside this envelope controllability must be demonstrated taking into account the considerations described in Section 7, above.

Mixed controllability/reliability compliance should be shown in accordance with guidance developed in Sections 7 and 8, above, respectively.

10. DEACTIVATED REVERSER.

The thrust reverser system deactivation design should follow the same «fail-safe» principles as the actuation system design, insofar as failure and systems/hardware integrity. The effects of thrust reverser system deactivation on other aeroplane systems, and on the new configuration of the thrust reverser system itself, should be evaluated according to Section 8.a., above. The location and load capability of the mechanical lock-out system (thrust reverser structure and lock-out device) should be evaluated according to Sections 8.b. and 8.d., above. The evaluation should show that the level of safety associated with the deactivated thrust reverser system is equivalent to or better than that associated with the active system.

11. JAR 25.933(b) COMPLIANCE.

For thrust reversing systems intended for inflight use, compliance with JAR 25.933(b) may be shown for unwanted inflight thrust reversal, as appropriate, using the methods specified in Sections 7 through 10, above.

12. CONTINUED AIRWORTHINESS.

12.a. Manufacturing/Quality: Due to the criticality of the thrust reverser, manufacturing and quality assurance processes should be assessed and implemented, as appropriate, to ensure the design integrity of the critical components.

12.b. Reliability Monitoring: An appropriate system should be implemented for the purpose of periodic monitoring and reporting of in-service reliability performance. The system should also include reporting of in-service concerns related to design, quality, or maintenance that have the potential of affecting the reliability of the thrust reverser.

12.c. Maintenance and Alterations: The following material provides guidance for maintenance designs and activity to assist in demonstrating compliance with Sections 7 through 10, above (also reference JAR 25.901(b)(2) and JAR 25.1529/Appendix H). The criticality of the thrust reverser and its control system requires that maintenance and maintainability be emphasised in the design process and derivation of the maintenance control program, as well as subsequent field maintenance, repairs, or alterations.

12.c.(1) Design: Design aspects for providing adequate maintainability should address :

12.c.(1)(a) Ease of maintenance. The following items should be taken into consideration:

- It should be possible to operate the thrust reverser for ground testing/trouble shooting without the engine operating.
- Lock-out procedures (deactivation for flight) of the thrust reverser system should be simple, and clearly described in the maintenance manual. Additionally, a placard describing the procedure may be installed in a conspicuous place on the nacelle.
- Provisions should be made in system design to allow easy and safe access to the components for fault isolation, replacement, inspection, lubrication, etc. This is particularly important where inspections are required to detect latent failures. Providing safe access should include consideration of risks both to the mechanic and to any critical design elements that might be inadvertently damaged during maintenance.
- Provisions should be provided for easy rigging of the thrust reverser and adjustment of latches, switches, actuators, etc.
-

12.c.(1)(b) Fault identification and elimination:

- System design should allow simple, accurate fault isolation and repair.
- System design personnel should be actively involved in the development, documentation, and validation of the troubleshooting/fault isolation manual and other maintenance publications. The systems design personnel should verify that maintenance assumptions critical to any SSA conclusion are supported by these publications (e.g., perform fault insertion testing to verify that the published means of detecting, isolating, and eliminating the fault are effective).
- Thrust reverser unstowed and unlocked indications should be easily discernible during preflight inspections.
- If the aeroplane has onboard maintenance monitoring and recording systems, the system should have provisions for storing all fault indications. This would be of significant help to maintenance personnel in locating the source of intermittent faults.

12.c.(1)(c) Minimisation of errors: Minimisation of errors during maintenance activity should be addressed during the design process. Examples include physical design features, installation orientation markings, dissimilar connections, etc. The use of a formal «lessons learned»-based review early and often during design development may help avoid repeating previous errors.

12.c.(1)(d) System Reliability: The design process should, where appropriate, use previous field reliability data for specific and similar components to ensure system design reliability.

12.c.(2) Maintenance Control:

12.c.(2)(a) Maintenance Program: The development of the initial maintenance plan for the aeroplane, including the thrust reverser, should consider, as necessary, the following:

- Involvement of the manufacturers of the aeroplane, engine, and thrust reverser.
- The compatibility of the SSA information and the Maintenance Review Board Report, Maintenance Planning Document, Master Minimum Equipment List, etc. (ref AMJ 25.19).
- Identification by the manufacturer of all maintenance tasks critical to continued safe flight. The operator should consider these tasks when identifying and documenting Required Inspection Items.
- The complexity of lock-out procedures and appropriate verification.
- Appropriate tests, including an operational tests, of the thrust reverser to verify correct system operation after the performance of any procedure that would require removal, installation, or adjustment of a component; or disconnection of a tube, hose, or electrical harness of the entire thrust reverser actuation control system.

12.c.(2)(b) Training: The following considerations should be taken into account when developing training documentation:

- The reason and the significance of accomplishing critical tasks as prescribed. This would clarify why a particular task needs to be performed in a certain manner.
- Instructions or references as to what to do if the results of a check or operational test do not agree with those given in the Aeroplane Maintenance Manual (AMM). The manual should recommend some corrective action if a system fails a test or check. This would help ensure that the critical components are not overlooked in the trouble shooting process.
- Emphasis on the total system training by a single training source (preferably the aeroplane manufacturer) to preclude fragmented information without a clear system understanding. This training concept should be used in the initial training and subsequent retraining.
- Inclusion of fault isolation and troubleshooting using the material furnished for the respective manuals.
- Evaluation of the training materials to assure consistency between the training material and the maintenance and troubleshooting manuals.

12.c.(2)(c) Repairs and Alterations: The Instructions for Continued Airworthiness essential to ensure that subsequent repairs or alterations do not unintentionally violate the integrity of the original thrust reverser system type design approval should be provided by the original airframe manufacturer. Additionally, the original airframe manufacturer should define a method of ensuring that this essential information will be evident to those that may perform and approve such repairs and alterations. One example would be maintaining the wire separation between relevant thrust reverser control electrical circuits. This sensitivity could be communicated by statements in appropriate manuals such as the Wiring Diagram Manual, and by decals or placards placed on visible areas of the thrust reverser and/or aeroplane structure.

12.c.(2)(d) Feedback of Service Experience: The maintenance process should initiate the feedback of service experience that will allow the monitoring of system reliability performance and improvements in system design and maintenance practices. Additionally, this service experience should be used to assure the most current and effective formal «lessons learned» design review process possible.

12.c.(2)(d)(i) Reliability Performance:

(Operators and Manufacturers should collaborate on these items:)

- Accurate reporting of functional discrepancies.
- Service investigation of hardware by manufacturer to confirm and determine failure modes and corrective actions if required.
- Update of failure rate data. (This will require co-ordination between the manufacturers and airlines.)

12.c.(2)(d)(ii) Improvements suggested by maintenance experience:

(This will provide data to effectively update these items:)

- Manuals
- Troubleshooting
- Removal/replacement procedures.

12.c.(2)(e) Publications/Procedures: The following considerations should be addressed in the preparation and revisions of the publications and procedures to support the thrust reverser in the field in conjunction with JAR 25.901(b)(2) and JAR 25.1529 (Appendix H).

12.c.(2)(e)(i) Documentation should be provided that describes a rigging check, if required after adjustment of any thrust reverser actuator drive system component.

12.c.(2)(e)(ii) Documentation should be provided that describes powered cycling of the thrust reverser to verify system integrity whenever maintenance is performed. This could also apply to any manual actuation of the reverser.

12.c.(2)(e)(iii) The reasons and the significance of accomplishing critical tasks should be included in the AMM.

12.c.(2)(e)(iv) The AMM should include instructions or references as to what to do if the results of a check or operational test do not agree with those given in the AMM.

12.c.(2)(e)(v) Provisions should be made to address inefficiencies and errors in the publications:

- Identified in the validation process of both critical and troubleshooting procedures.
- Input from field.
- Operators conferences.

12.c.(2)(e)(vi) Development of the publications should be a co-ordinated effort between the thrust reverser, engine, aeroplane manufacturers and airline customers especially in the areas of:

- AMM
- Troubleshooting
- Fault isolation
- Maintenance data computer output
- Procedure Validation
- Master Minimum Equipment List

12.c.(2)(e)(vii) Initial issue of the publication should include the required serviceable limits for the complete thrust reverser system.

13. FLIGHT CREW TRAINING.

In the case of compliance with the «controllability option», and when the nature of the inflight thrust reversal is judged as unusual (compared to expected consequences on the aeroplane of other failures, both basic and recurrent), flight crew training should be considered on a training simulator that is equipped with thrust reverser inflight modelisation to avoid flight crew misunderstandings:

13.a. Transient manoeuvre: Recovery from the unwanted inflight thrust reversal.

13.b. Continued flight and landing: Manoeuvring appropriate to the recommended procedure (included trim and unattended operation) and precision tracking (ILS guide slope tracking, speed/altitude tracking, etc.).

– END –

SPECIAL CONDITION and IM	E-05 SC &IM: Sustained Engine Imbalance
APPLICABILITY:	A380
REQUIREMENTS:	JAR 25.571, 25.901(c), 25.903(c), 25.1309
ADVISORY MATERIAL:	AC 25-24

BACKGROUND

Service experience has shown that engine blade and bearing mechanical or structural failures may lead to high imbalance and vibratory loads in the airframe and engine. These vibratory loads may cause damage to primary structure and critical systems. Furthermore, vibrations on the flight deck may create a problem for the flight crew in flying the aeroplane. This CRI addresses the effects of sustained vibrations resulting from the failed engine, both before spool down and during the subsequent wind milling event. The dynamic transient loads occurring as a result of engine seizure and deceleration are not covered by this CRI.

The A380 will be equipped, like other recent large transport aeroplanes, with large diameter, high bypass ratio turbofans featuring large chord fan blades. Those design characteristics are likely to lead to large engine imbalance loads following a fan blade loss or shaft support failure, with potentially critical consequences at aircraft level.

JAR 903(c) says:

“Control of engine rotation

There must be means for stopping the rotation of any engine individually in flight, except that for turbine engine installations the means for stopping the rotation need to be provided only where continued rotation would jeopardise the safety of the aeroplane.....”

This paragraph originates from the time turbine engines were small diameter, low by pass ratio engines.

However, large by pass ratio turbofans are practically impossible to stop in flight.

Existing requirements are not adequately addressing the problem of engine imbalance on large bypass ratio turbofans, and service experience has shown that engine imbalance may lead to critical conditions on similar products. Therefore, according to JAR 21.16(a)(1) and (a)(3), there is a need to issue a Special Condition and associated Interpretative Material on the subject.

SPECIAL CONDITION

It must be shown by a combination of tests and analyses, that Airbus A380 aircraft is capable of continued safe flight and landing under the following conditions:

a. Wind milling condition:

This condition occurs after complete loss of an engine fan blade, or after a shaft support failure, including ensuing damage to other parts of the engine.

The evaluation must show that during continued operation at wind milling engine rotational speeds, the engine induced vibrations will not cause damage to either the primary structure of the aeroplane, or to critical equipment that would jeopardise continued safe flight and landing.

The evaluation must consider the effects from the possible damage to primary structure, including, but not limited to, engine mounts, wing, and flight control surfaces, as well as inlets, nacelles, and critical equipment (including connectors) mounted on the engine or the airframe. The degree of flight deck vibration must not prevent the flight crew from operating the aeroplane in a safe manner during all phases of flight.

The evaluation must cover the expected diversion time for the aeroplane.

(See AC 25-24 Chapter 5)

b. High power condition:

This condition occurs immediately after partial engine blade failure which may not be sufficient to cause the engine to spool down on its own. It must be shown that:

- The attitude, airspeed, and altimeter indications will withstand the vibratory environment and operate accurately in that environment.

- Adequate cues are available to the flight crew to determine which engine is damaged.

(See AC 25-24 Chapter 9)

INTERPRETATIVE MATERIAL**AC 25-24**

1. PURPOSE. This advisory circular (AC) sets forth an acceptable means, but not the only means, of demonstrating compliance with the provisions of 14 CFR part 25 related to the aircraft design for sustained engine rotor imbalance conditions. Terms used in this AC, such as “shall” or “must,” are used only in the sense of ensuring applicability of this particular method of compliance when the acceptable method of compliance described herein is used. While these guidelines are not mandatory, they are derived from extensive Federal Aviation Administration (FAA) and industry experience in determining compliance with the pertinent Federal Aviation Regulations (FAR). This AC does not change, create any additional, authorize changes in, or permit deviations from, regulatory requirements.
2. RELATED DOCUMENTS.
 - a. Title 14, Code of Federal Regulations (14 CFR) part 25.
 - § 25.571 Damage-tolerance and fatigue evaluation of structure.
 - § 25.629 Aeroelastic stability requirements.
 - § 25.901 Installation.
 - § 25.903 Engines.
 - b. Title 14, Code of Federal Regulations (14 CFR) part 33.
 - § 33.74 Continued rotation.
 - § 33.94 Blade containment and rotor unbalance tests.
 - c. Advisory Circulars (AC).
 - AC 25.571-1C Damage-Tolerance and Fatigue Evaluation of Structure.
 - d. Industry Documents.
 - “Engine Windmilling Imbalance Loads - Final Report,” dated July 1, 1997, Aviation Rulemaking Advisory Committee (ARAC) recommendations to the FAA.
 - “Verification of Methods for Damage Tolerance Evaluation of Aircraft Structures to FAA Requirements,” by Tom Swift, FAA, 12th International Committee on Aeronautical Fatigue, May 25, 1983, Figures 42 and 43.
3. DEFINITIONS. Some new terms have been defined for the imbalance condition in order to present criteria in a precise and consistent manner. In addition, some terms are employed from other fields and may not be in general use as defined below. The following definitions apply in this AC:
 - a. Airborne Vibration Monitor (AVM). A device used for monitoring the operational engine vibration levels that are unrelated to the failure conditions considered by this advisory circular.

- b. Design Service Goal (DSG). The design service goal is a period of time (in flight cycles/hours) established by the applicant at the time of design and/or certification and used in showing compliance with § 25.571.
 - c. Diversion Flight. The segment of the flight between the point where deviation from the planned route is initiated in order to land at an en route alternate airport and the point of such landing.
 - d. Ground Vibration Test (GVT). Ground resonance tests of the airplane normally conducted in compliance with § 25.629.
 - e. Imbalance Design Fraction (IDF). The ratio of the design imbalance to the imbalance (including all collateral damage) resulting from tests of a single release of a turbine, compressor, or fan blade at redline speed (as usually conducted for compliance with § 33.94).
 - f. Low Pressure (LP) Rotor. The rotating system, which includes the low pressure turbine and compressor components and a connecting shaft.
 - g. Well Phase. The flight hours accumulated on an airplane or component before the failure event.
4. BACKGROUND.
- a. Requirements. Section 25.901(c) requires that no single failure or malfunction or probable combination of failures in the powerplant installation will jeopardize the safe operation of the airplane. In addition, § 25.903(c) requires means of stopping the rotation of an engine where continued rotation could jeopardize the safety of the airplane, and § 25.903(d) requires that design precautions be taken to minimize the hazards to the airplane in the event of an engine rotor failure.
 - b. Blade Failure. The failure of a fan blade and the subsequent damage to other rotating parts of the fan and engine may induce significant structural loads and vibration throughout the airframe that may damage the nacelles, critical equipment, engine mounts, and airframe primary structure. Also, the effect of flight deck vibration on displays and equipment is of significance to the crew's ability to make critical decisions regarding the shut down of the damaged engine and their ability to carry out other operations during the remainder of the flight. The vibratory loads resulting from the failure of a fan blade have traditionally been regarded as insignificant relative to other portions of the design load spectrum for the airplane. However, the progression to larger fan diameters and fewer blades with larger chords has changed the significance of engine structural failures that result in an imbalanced rotating assembly. This condition is further exacerbated by the fact that fans will continue to windmill in the imbalance condition following engine shut down. Current rules require provisions to stop the windmilling rotor where continued rotation could jeopardize the safety of the airplane. However, large high bypass ratio fans are practically impossible to stop in flight.
 - c. Shaft Support Failure. Service experience has shown that failures of shaft bearings and shaft support structure have also resulted in sustained high vibratory loads similar to the sustained imbalance loads resulting from fan blade loss.
 - d. Imbalance Conditions. There are two sustained imbalance conditions that may affect safe flight: the windmilling condition and a separate high power condition.

- (1) Windmilling Condition. The windmilling condition results after the engine is spooled down but continues to rotate under aerodynamic forces. The windmilling imbalance condition results from shaft support failure or loss of a fan blade along with collateral damage. This condition may last until the airplane completes its diversion flight, which could be several hours.
 - (2) High Power Condition. The high power imbalance condition occurs immediately after blade failure but before the engine is shut down or otherwise spools down. This condition addresses losing less than a full fan blade which may not be sufficient to cause the engine to spool down on its own. This condition may last from several seconds to a few minutes. In some cases it has hampered the crew's ability to read instruments that may have aided in determining which engine was damaged.
- e. The Aviation Rulemaking Advisory Committee (ARAC) has developed recommendations regarding design criteria and analytical methodology for assessing the engine imbalance event. ARAC submitted those recommendations to the FAA in the report "Engine Windmilling Imbalance Loads - Final Report," dated July 1, 1997. The information provided in this AC is derived from the recommendations in that report.
- f. The criteria presented in this AC are based on a statistical analysis of 25 years of service history of high by-pass ratio engines with fan diameters of 60 inches or greater. Although the study conducted by ARAC was limited to these larger engines, the criteria and methodology are also acceptable for use on smaller engines.

5. EVALUATION OF THE WINDMILLING IMBALANCE CONDITIONS.

- a. Objective. It should be shown by a combination of tests and analyses that after partial or complete loss of an engine fan blade, including collateral damage, or after shaft support failure, the airplane is capable of continued safe flight and landing.
- b. Evaluation. The evaluation should show that during continued operation at Windmilling engine rotational speeds, the induced vibrations will not cause damage that would jeopardize continued safe flight and landing. The degree of flight deck vibration should not prevent the flightcrew from operating the airplane in a safe manner. This includes the ability to read and accomplish checklist procedures.

This evaluation should consider:

- (1) The damage to airframe primary structure including, but not limited to, engine mounts and flight control surfaces,
 - (2) The damage to nacelle components, and
 - (3) The effects on critical equipment (including connectors) mounted on the engine or airframe.
- c. Blade Loss Imbalance Conditions.
- (1) Windmilling Blade Loss Conditions. The duration of the windmilling event should cover the expected diversion time of the airplane. An evaluation of service experience indicates that the probability of the combination of a 1.0 IDF and a 1-hour diversion is on the order of 10^{-7} to 10^{-8} while the probability of the combination of a 1.0 IDF and a 3-hour diversion is 10^{-9} or less. Therefore, with an IDF of 1.0, it would not be necessary to consider diversion times greater than 3-hours. In addition, the 3-hour diversion should be evaluated using nominal and realistic flight conditions and parameters. The following two separate conditions with an IDF of 1.0 are prescribed for application of the subsequent criteria which are developed consistent with the probability of occurrence:

- (a) A 1-hour diversion flight.
- (b) If the maximum diversion time established for the airplane exceeds 1-hour, a diversion flight of a duration equal to the maximum diversion time, but not exceeding 3-hours.

(2) Airplane Flight Loads and Phases.

- (a) Loads on the airplane components should be determined by dynamic analysis. At the start of the windmill event, the airplane is assumed to be in level flight with a typical payload and realistic fuel loading. The speeds, altitudes, and flap configurations considered may be established according to the Airplane Flight Manual (AFM) procedures. The analysis should take into account unsteady aerodynamic characteristics and all significant structural degrees of freedom including rigid body modes. The vibration loads should be determined for the significant phases of the diversion profiles described in paragraphs 5c(1)(a) and (b) above.
- (b) The significant phases are:
 - 1 The initial phase during which the pilot establishes a cruise condition;
 - 2 The cruise phase;
 - 3 The descent phase; and
 - 4 The approach to landing phase.
- (c) The flight phases may be further divided to account for variation in aerodynamic and other parameters. The calculated loads parameters should include the accelerations needed to define the vibration environment for the systems and flight deck evaluations. A range of windmilling frequencies to account for variation in engine damage and ambient temperature should be considered.

(3) Strength Criteria.

- (a) The primary airframe structure should be designed to withstand the flight and windmilling vibration load combinations defined in paragraphs 1, 2, and 3 below.
 - 1 The peak vibration loads for the flight phases in paragraphs 5c(2)(b)1 and 3 above, combined with appropriate 1g flight loads. These loads should be considered limit loads, and a factor of safety of 1.375 should be applied to obtain ultimate load.
 - 2 The peak vibration loads for the approach to landing phase in paragraph 5c(2)(b)4 above, combined with appropriate loads resulting from a positive symmetrical balanced manoeuvring load factor of 1.15 g. These loads should be considered as limit loads, and a factor of safety of 1.375 should be applied to obtain ultimate load.
 - 3 The vibration loads for the cruise phase in paragraph 5c(2)(b)2 above, combined with appropriate 1g flight loads and 70 percent of the flight manoeuvre loads up to the maximum likely operational speed of the airplane. These loads are considered to be ultimate loads.
 - 4 The vibration loads for the cruise phase in paragraph 5c(2)(b)2 above, combined with appropriate 1g flight loads and 40 percent of the limit gust velocity of § 25.341 as specified at VC (design cruising speed) up to the maximum likely operational speed of the airplane. These loads are considered to be ultimate loads.
- (b) In selecting material strength properties for the static strength analyses, the requirements of § 25.613 apply.

(4) Assessment of Structural Endurance.

- (a) Criteria for fatigue and damage tolerance evaluations of primary structure are summarized in Table 1 below. Both of the conditions described in paragraphs 5c(1)(a) and (b) above should be evaluated. Different levels of structural endurance capability are provided for these conditions. The criteria for the condition in paragraph 5c(1)(b) are set to ensure at least a 50 percent probability of preventing a structural component failure. The criteria for the condition in paragraph 5c(1)(a) are set to ensure at least a 95 percent probability of preventing a structural component failure. These criteria are consistent with the probability of occurrences for these events discussed in paragraph 5(c)(1) above.
- (b) For multiple load path and crack arrest "fail-safe" structure, either a fatigue analysis per paragraph 1 below, or damage tolerance analysis per paragraph 2 below, may be performed to demonstrate structural endurance capability. For all other structure, the structural endurance capability should be demonstrated using only the damage tolerance approach of paragraph 2 below. The definitions of multiple load path and crack arrest "fail-safe" structure are the same as defined for use in showing compliance with § 25.571, "Damage tolerance and fatigue evaluation of structure."

1 Fatigue Analysis. Where a fatigue analysis is used for substantiation of multiple load path "fail-safe" structure, the total fatigue damage accrued during the well phase and the windmilling phase should be considered. The analysis should be conducted considering the following:

- (aa) For the well phase, the fatigue damage should be calculated using an approved load spectrum (such as used in satisfying the requirements of § 25.571) for the durations specified in Table 1. Average material properties may be used.
- (bb) For the windmilling phase, fatigue damage should be calculated for the diversion profiles using a diversion profile consistent with the AFM recommended operations, accounting for transient exposure to peak vibrations, as well as the more sustained exposures to vibrations. Average material properties may be used.
- (cc) For each component, the accumulated fatigue damage specified in Table 1 should be shown to be less than or equal to the fatigue damage to failure of the component.

2 Damage Tolerance Analysis. Where a damage tolerance approach is used to establish the structural endurance, the airplane should be shown to have adequate residual strength during the specified diversion time. The extent of damage for residual strength should be established, considering growth from an initial flaw assumed present since the airplane was manufactured. Total flaw growth will be that occurring during the well phase, followed by growth during the windmilling phase. The analysis should be conducted considering the following:

- (aa) The size of the initial flaw should be equivalent to a manufacturing quality flaw associated with a 95 percent probability of existence with 95 percent confidence (95/95).
- (bb) For the well phase, crack growth should be calculated starting from the initial flaw defined in paragraph 5c(4)(b)2(aa) above, using an approved load spectrum (such as used in satisfying the requirements of § 25.571) for the duration specified in Table 1. Average material properties may be used.
- (cc) For the windmilling phase, crack growth should be calculated for the diversion profile starting from the crack length calculated in paragraph 5c(4)(b)2(bb) above. The diversion profile should be consistent with the AFM recommended operation accounting for transient exposure to peak vibrations as well as the

more sustained exposures to vibrations. Average material properties may be used.

- (dd) The residual strength for the structure with damage equal to the crack length calculated in paragraph 5c(4)(b)2(cc) above should be shown capable of sustaining the combined loading conditions defined in paragraph 5c(3)(a) above with a factor of safety of 1.0.

TABLE 1 - Fatigue and Damage Tolerance

Condition	Paragraph 5c(1)(a)	Paragraph 5c(1)(b)
Imbalance Design Fraction (IDF)	1.0	1.0
Diversion time	A 60-minute diversion	The maximum expected diversion ⁶
Fatigue Analysis ^{1,2} (average material properties)	Well phase	Damage for 1 DSG
	Windmilling phase	Damage due to 60 minutes diversion under a 1.0 IDF imbalance condition.
	Criteria	Demonstrate no failure ⁷ under twice the total damage due to the well phase and the windmilling phase.
Damage Tolerance ^{1,2} (average material properties)	Well phase	Manufacturing quality flaw ³ (MQF) grown for 1 DSG
	Windmilling phase ^{3,4}	Additional crack growth for 60 minute diversion with an IDF = 1.0
	Criteria	Positive margin of safety with residual strength loads specified in 5c(3)(a) for the final crack length

Notes:

¹ The analysis method that may be used is described in paragraph 5 (Evaluation of the Windmilling Imbalance Conditions) of this Advisory Circular.

² Load spectrum to be used for the analysis is the same load spectrum qualified for use in showing compliance with § 25.571, augmented with windmilling loads as appropriate.

³ Windmilling phase is to be demonstrated following application of the well phase spectrum loads.

⁴ The initial flaw for damage tolerance analysis of the windmilling phase need not be greater than the flaw size determined as the detectable flaw size plus growth under well phase spectrum loads for one inspection period for mandated inspections.

⁵ MQF is the manufacturing quality flaw associated with 95/95 probability of existence. (Reference - 'Verification of Methods For Damage Tolerance Evaluation of Aircraft Structures to FAA Requirements', Tom Swift FAA, 12th International Committee on Aeronautical Fatigue, 25 May 1983, Figures 42, and 43.)

⁶ Maximum diversion time for condition 5c(1)(b) is the maximum diversion time established for the airplane, but need not exceed 180 minutes. This condition should only be investigated if the diversion time established for the airplane exceeds 60 minutes.

⁷ The allowable cycles to failure may be used in the damage calculations.

(5) **Systems Integrity.**

- (a) It should be shown that systems required for continued safe flight and landing after a blade-out event will withstand the vibratory environment defined for the Windmilling conditions and diversion times described above. For this evaluation, the airplane is assumed to be dispatched in its normal configuration and condition.

Additional conditions associated with the Master Minimum Equipment List (MMEL) need not be considered in combination with the blade-out event.

- (b) The initial flight environmental conditions are assumed to be night, instrument meteorological conditions (IMC) enroute to nearest alternate airport, and approach landing minimum of 300 feet and 3/4 mile or runway visual range (RVR) 4000 or better.

- (6) Flightcrew Response. For the windmilling condition described above, the degree of flight deck vibration shall not inhibit the flight crew's ability to continue to operate the airplane in a safe manner during all phases of flight.

- d. Shaft Support Failure. To evaluate these conditions, the LP rotor system should be analyzed with each bearing removed, one at a time, with the initial imbalance consistent with the AVM advisory level. The analysis should include the maximum operating LP rotor speed (assumed bearing failure speed), spool down, and windmilling speed regions. The effect of gravity, inlet steady air load, and significant rotor to stator rubs and gaps should be included. If the analysis or experience indicates that secondary damage such as additional mass loss, secondary bearing overload, permanent shaft deformation, or other structural changes affecting the system dynamics occur during the event, the model should be revised to account for these additional effects. The objective of the analyses is to show that the loads and vibrations produced by the shaft support failure event are less than those produced by the blade loss event across the same frequency range.

6. ANALYSIS METHODOLOGY.

- a. Objective of the Methodology. The airplane response analysis for engine Windmilling imbalance is a structural dynamic problem. The objective of the methodology is to develop acceptable analytical tools for conducting dynamic investigations of imbalance events. The goal of the windmilling analyses is to produce loads and accelerations suitable for structural, systems, and flight deck evaluations.
- b. Scope of the Analysis. The analysis of the airplane and engine configuration should be sufficiently detailed to determine the windmilling loads and accelerations on the airplane. For airplane configurations where the windmilling loads and accelerations are shown not to be significant, the extent and depth of the analysis may be reduced accordingly.
- c. Results of the Analysis. The windmilling analyses should provide loads and accelerations for all parts of the primary structure. The evaluation of equipment and human factors may require additional analyses or tests. For example, the analysis may need to produce floor vibration levels, and the human factors evaluation may require a test (or analysis) to subject the seat and the human subject to floor vibration.

7. MATHEMATICAL MODELING.

- a. Components of the Integrated Dynamic Model. Airplane dynamic responses should be calculated with a complete integrated airframe and engine analytical model. The airplane model should be to a similar level of detail to that used for certification flutter and dynamic gust analyses, except that it should also be capable of representing asymmetric responses. The dynamic model used for windmilling analyses should be representative of the airplane to the highest windmilling frequency expected. The integrated dynamic model consists of the following components:
- (1) Airframe structural model,
 - (2) Engine structural model,
 - (3) Control system model,
 - (4) Aerodynamic model, and

(5) Forcing function and gyroscopic effects.

b. **Airframe Structural Model.** An airframe structural model is necessary in order to calculate the response at any point on the airframe due to the rotating imbalance of a Windmilling engine. The airframe structural model should include the mass, stiffness, and damping of the complete airframe. A lumped mass and finite element beam representation is considered adequate to model the airframe. This type of modeling represents each airframe component, such as fuselage, empennage, and wings, as distributed lumped masses rigidly connected to weightless beams that incorporate the stiffness properties of the component. A full airplane model capable of representing asymmetric responses is necessary for the windmilling imbalance analyses.

Appropriate detail should be included to ensure fidelity of the model at windmilling frequencies.

A more detailed finite element model of the airframe may also be acceptable. Structural damping used in the windmilling analysis may be based on Ground Vibration Test (GVT) measured damping.

c. **Engine Structural Model.**

(1) Engine manufacturers construct various types of dynamic models to determine loads and to perform dynamic analyses on the engine rotating components, its static structures, mounts, and nacelle components. Dynamic engine models can range from a centerline two-dimensional (2D) model, to a centerline model with appropriate three-dimensional (3D) features such as mount and pylon, up to a full 3D finite element model (3D FEM). Any of these models can be run for either transient or steady state conditions.

(2) These models typically include all major components of the propulsion system, such as the nacelle intake, fan cowl doors, thrust reverser, common nozzle assembly, all structural casings, frames, bearing housings, rotors, and a representative pylon. Gyroscopic effects are included. The models provide for representative connections at the engine-to-ylon interfaces as well as all interfaces between components (e.g., inlet-to-engine and engine-to-thrust reverser).

The engine that is generating the imbalance forces should be modeled in this level of detail, while the undamaged engines that are operating normally need only to be modeled to represent their sympathetic response to the airplane windmilling condition.

(3) Features modeled specifically for blade loss windmilling analysis typically include fan imbalance, component failure and wear, rubs (blade to casing, and intershaft), and resulting stiffness changes. Manufacturers whose engines fail the rotor support structure by design during the blade loss event should also evaluate the effect of the loss of support on engine structural response during windmilling.

(4) Features that should be modeled specifically for shaft support failure Windmilling events include the effects of gravity, inlet steady air loads, rotor to stator structure friction and gaps, and rotor eccentricity. Secondary damage should be accounted for, such as additional mass loss, overload of other bearings, permanent shaft deformation, or other structural changes affecting the system dynamics, occurring during rundown from maximum LP rotor speed and subsequent windmilling.

d. **Control System Model.** The automatic flight control system should be included in the analysis unless it can be shown to have an insignificant effect on the airplane response due to engine imbalance.

e. Aerodynamic Model. The aerodynamic forces can have a significant effect on the structural response characteristics of the airframe. While analysis with no aerodynamic forces may be conservative at most frequencies, this is not always the case. Therefore, a validated aerodynamic model should be used. The use of unsteady three-dimensional panel theory methods for incompressible or compressible flow, as appropriate, is recommended for modelling of the windmilling event. Interaction between aerodynamic surfaces and main surface aerodynamic loading due to control surface deflection should be considered where significant.

The level of detail of the aerodynamic model should be supported by tests or previous experience with applications to similar configurations. Main and control surface aerodynamic derivatives should be adjusted by weighting factors in the aeroelastic response solutions. The weighting factors for steady flow ($k=0$) are usually obtained by comparing wind tunnel test results with theoretical data.

f. Forcing Function and Gyroscopic Forces. Engine gyroscopic forces and imbalance forcing function inputs should be considered. The imbalance forcing function should be calibrated to the results of the test performed under § 33.94.

8. VALIDATION.

a. Range of Validation. The analytical model should be valid to the highest Windmilling frequency expected.

b. Airplane Structural Dynamic Model. The measured GVT normally conducted for compliance with § 25.629 may be used to validate the analytical model throughout the windmilling range. These tests consist of a complete airframe and engine configuration subjected to vibratory forces imparted by electro-dynamic shakers.

(1) Although the forces applied in the ground vibration test are small compared to the windmilling forces, these tests yield reliable linear dynamic characteristics (structural modes) of the airframe and engine combination. Furthermore, the windmilling forces are far less than would be required to induce nonlinear behavior of the structural material (i.e. yielding).

Therefore, a structural dynamic model that is validated by ground vibration test is considered appropriate for the windmilling analysis.

(2) The ground vibration test of the airplane may not necessarily provide sufficient information to assure that the transfer of the windmilling imbalance loads from the engine is accounted for correctly. The load transfer characteristics of the engine to airframe interface via the pylon should be validated by test and analysis correlation. In particular, the effect of the point of application of the load on the dynamic characteristics of the integrated model should be investigated in the ground vibration test by using multiple shaker locations.

(3) Structural damping values obtained in the ground vibration tests are considered conservative for application to windmilling dynamic response analysis. Application of higher values of damping consistent with the larger amplitudes associated with windmilling analysis should be justified.

c. Aerodynamic Model. The dynamic behavior of the whole airplane in air at the structural frequency range associated with windmilling is normally validated by the flight flutter tests performed under § 25.629.

d. Engine Model. The model is validated based on dedicated vibration tests and results of the § 33.94 fan blade loss test. In cases where compliance with § 33.94 is granted by similarity instead of test, the model should be correlated to prior experience.

(1) Validation of the engine model static structure, including the pylon, is achieved by a combination of engine and component tests that include structural tests on major load path components. The adequacy of the engine model to predict rotor critical speeds and forced response behavior is verified by measuring engine vibratory response when imbalances are added to the fan and other rotors. Vibration data are routinely monitored on a number of engines during the engine development cycle, thereby providing a solid basis for model correlation.

(2) While the validation aspects listed above are important for representation of the windmilling loads, the fan blade loss correlation is also pertinent to the windmilling event because the event involves predicting the response of the entire propulsion system under a high level imbalance load. Correlation of the model against the § 33.94 test is a demonstration that the model accurately predicts initial blade release event loads, any rundown resonant response behavior, frequencies, potential structural failure sequences, and general engine movements and displacements. To enable this correlation to be performed, instrumentation of the blade loss engine test is used (e.g. high speed cinema and video cameras, accelerometers, strain gauges, continuity wires, and shaft speed tachometers).

9. HIGH POWER IMBALANCE CONDITION.

a. An imbalance condition equivalent to 50 percent of one blade at cruise rotor speed considered to last for 20 seconds may be assumed. It should be shown that attitude, airspeed, and altimeter indications will withstand the vibratory environment of the high power condition and operate accurately in that environment. Adequate cues should be available to determine which engine is damaged. Strength and structural endurance need not be considered for this condition.

– END –

EQUIVALENT SAFETY FINDING and IM	E-06 ESF & IM: Falling and blowing snow
APPLICABILITY:	A380
REQUIREMENTS:	JAR25.1093(b)
ADVISORY MATERIAL:	N/A

BACKGROUND

Current JAR 25 change 15 does not contain a requirement that engine must operate in falling and blowing snow within the limitations established for such operation. Such a requirement has been introduced in FAR 25.1093, through amendment 72.

Airbus elected to comply with NPA 25E-288 dated November 16, 1997, which is proposing to introduce “falling and blowing snow” requirements in JAR 25.

For A380 an equivalent Safety Finding is necessary

EQUIVALENT SAFETY FINDING

Add a paragraph (ii) to JAR 25.1093 (b)(1) to read as follows :

"JAR 25.1093 Air intake system de-icing and anti-icing provisions

(b) Turbine engines

- (1) Each turbine engine must operate throughout the flight power range of the engine (including idling), without the accumulation of ice on the engine, inlet system components, or airframe components that would adversely affect operation or cause a serious loss of power or thrust (see ACJ 25.1093(b)).

- (i) Under the icing conditions specified in Appendix C.
- (ii) In falling and blowing snow within the limitations established for the aeroplane for such operation."

INTERPRETATIVE MATERIAL

"ACJ No 2 to JAR25.1093(b)

Propulsion Engine Air Intakes Falling and Blowing Snow. (Acceptable Means of Compliance and Interpretative Material)

See JAR25.1093(b)

Falling and blowing snow is a weather condition, which needs to be considered for the power plants and essential Auxiliary Power Units (APUs) of transport category aeroplanes.

Although snow conditions can be encountered on the ground or in flight, there is little evidence that snow can cause adverse effects in flight on turbojet and turbofan engines with traditional pitot style inlets where protection against icing conditions is provided. However, service history has shown that inflight snow (and mixed phase) conditions have caused power interruptions on some turbine engines and APUs with inlets that incorporate plenum chambers, reverse flow, or particle separating design features.

For turbojet and turbofan engines with traditional pitot (straight duct) type inlets, icing conditions are generally regarded as a more critical case than falling and blowing snow. For these types of inlet, compliance with the icing requirements will be accepted in lieu of any specific snow testing or analysis.

For non-pitot inlet types, demonstration of compliance with the falling and blowing snow ground conditions should be conducted by tests and/or analysis. If acceptable powerplant operation can be shown in the following conditions, no take-off restriction on the operation of the aeroplane in snow will be necessary.

- a. Visibility: 0.4 Km or less as limited by snow, provided this low visibility is only due to falling snow (i.e. no fog). This condition corresponds approximately to 1 g/m³.
 - b. Temperatures: -3°C to +2°C for wet (sticky) snow and -9°C to -2°C for dry snow, unless other temperatures are found to be critical (e.g. where dry snow at a lower temperature could cause runback ice where it contacts a heated surface).
 - c. Blowing snow: Where tests are conducted, the effects of blowing snow may be simulated by taxiing the aircraft at 15 to 25 kts, or by using another aircraft to blow snow over the test powerplant. This condition corresponds approximately to 3g/m³.
 - d. Duration: It must be shown that there is no accumulation of snow or slush in the engine, inlet system or on airframe components, which would adversely affect engine operation during any intended ground operation. Compliance evidence should consider a duration which corresponds to the achievement of a steady state condition of accretion and (possible) shedding. Any snow shedding should be acceptable to the engine.
- c. Operation: The methods for evaluating the effects of snow on the powerplant should be agreed by the Authority. All types of operation likely to be used on the ground should be considered for the test (or analysis). This should include prolonged idling and power transients consistent with taxiing and other ground manoeuvring conditions. Where any accumulation does occur, the engine should be run up to full power, to simulate take-off conditions and demonstrate that no hazardous shedding of snow or slush occurs. Adequate means should be used to determine the presence of any hazardous snow accumulation.
- d. For inflight snow (and mixed phase) conditions, some non-pitot type inlets with reverse flow particle separators have been found to accumulate snow/ice in the pocket lip (sometimes referred to as the "birdcatcher" section) just below the splitter which divides the engine compressor from the inlet bypass duct. Eventually, the buildup of snow in the pocket (which can melt and refreeze into ice) either spans across to the compressor inlet side of the splitter lip or, the snow/ice buildup is released from the pocket and breaks up whereupon some of the ice pieces can be reingested into the compressor side of the inlet. The ingestion of this snow/ice has caused momentary or permanent flameouts and in some cases, foreign object damage to the compressor.

Some airframe manufacturers have tried to correct this condition by increasing the amount and/or frequency of applied thermal heat used around the pocket, splitter, and bypass sections of the inlet. However, short of modifying the engine ice protection systems to the point of operating fully evaporative, these fixes have mostly failed to achieve acceptable results.

Airplanes with turbine engine or essential APU inlets which have plenum chambers, screens, particle separators, variable geometry, or any other feature (such as an oil cooler) which may provide a hazardous accumulation site for snow should be qualitatively evaluated for inflight snow conditions. The qualitative assessment should include:

- 1) A visual review of the installed engine and inlet (or drawings) to identify potential snow accumulation sites.
- 2) Review of the engine and engine inlet ice protection systems to determine if the systems were designed to run wet, fully evaporative, or just de-ice during icing conditions?
- 3) Unless the inlet ice protection means (e.g. thermal blanket, compressor bleed air, hot oil) operates in a fully evaporative state in and around potential inlet accumulation sites, inlet designs with reverse flow pockets exposed directly to inflight snow ingestion should be avoided."

– END –

EQUIVALENT SAFETY FINDING and IM	E-09 ESF & IM: Fuel Tank crashworthiness
APPLICABILITY:	A380
REQUIREMENTS:	JAR 25.963(d) and (e)
ADVISORY MATERIAL:	ACJ 25.963(d), INT/POL/25/9

BACKGROUND

On several past certification exercises, the fuel pressure loads to be taken into account in emergency landing conditions have been subject of discussions.

Airbus proposed to elect to comply to a recently harmonised set of design criteria for fuel tank emergency loads. Airbus has requested an equivalent safety finding to the existing acceptable criteria from JAA, as defined in INT/POL/25/9.

In the meantime, the JAA have issued INT/POL/25/9 issue 2 which incorporates partially the proposals of the harmonisation working on the subject.

EQUIVALENT SAFETY FINDING

Replace JAR 25.963(d) by the following :

Fuel tanks must, so far as is practical, be designed, located, and installed so that no fuel is released, in quantities sufficient to start a serious fire, in otherwise survivable emergency landing conditions; and:

- (1) All fuel tanks must be able to resist rupture and to retain fuel under ultimate hydrostatic design conditions in which the pressure P within the tank varies in accordance with the formula:

$$P = 0.34 * K * L$$

where:

- P = fuel pressure in psi at each point within the tank;
- L = a reference distance in feet between the point of pressure and the tank farthest boundary in the direction of loading;
- K = 4.5 for the forward loading condition for fuel tanks outside the fuselage contour;
- K = 9 for the forward loading condition for fuel tanks within the fuselage contour;
- K = 1.5 for the aft loading condition;
- K = 3.0 for the inboard and outboard loading conditions for fuel tanks within the fuselage contour;
- K = 1.5 for the inboard and outboard loading conditions for fuel tanks outside of the fuselage contour;
- K = 6 for the downward loading condition;
- K = 3 for the upward loading condition.

- (2) For those (parts of) wing fuel tanks near the fuselage and near the engines, the greater of the fuel pressures resulting from subparagraphs (a) and (b) must be used:

(a) the fuel pressures resulting from subparagraph (1) above, and:

(b) the lesser of the two following conditions:

- (i) Fuel pressures resulting from the accelerations as specified in JAR 25.561(b)(3) considering the fuel tank full of fuel at maximum fuel density. Fuel pressures based on the 9.0g forward acceleration may be calculated using the fuel static head equal to the stream wise local chord of the tank. For inboard and outboard conditions, an acceleration of 1.5g may be used in lieu of 3.0 g as specified in JAR 25.561(b)(3);

- (ii) Fuel pressures resulting from the accelerations as specified in JAR 25.561(b)(3) considering a fuel volume beyond 85% of the maximum permissible volume in each tank using the static head associated with the 85% fuel level. A typical density of the appropriate fuel may be used.
For inboard and outboard conditions, an acceleration of 1.5g may be used in lieu of 3.0g as specified in JAR 25.561(b)(3).
- (3) Fuel tank internal barriers and baffles may be considered as solid boundaries if shown to be effective in limiting fuel flow.

INTERPRETATIVE MATERIAL

(1) Outside/within the fuselage contour

The phrase “fuel tanks outside the fuselage contour” is intended to include all fuel tanks where fuel spillage through any tank boundary would remain physically and environmentally isolated from occupied compartments by a barrier that is at least fire resistant as defined in JAR-1. In this regard, cargo compartments that share the same environment with occupied compartments would be treated the same as if they were occupied. The ultimate pressure criteria are different depending on whether the fuel tank under consideration is inside, or outside the fuselage contour. For the purposes of this Interim Policy a fuel tank should be considered inside the fuselage contour if it is inside the fuselage pressure shell. If part of the fuel tank pressure boundary also forms part of the fuselage pressure boundary then that part of the boundary should be considered as being within the fuselage contour.

(2) Near the fuselage/near the engines

(a) For aircraft with wing mounted engines:

- (i) The phrase “near the fuselage” is addressing those (parts of) wing fuel tanks located between the fuselage and the most inboard engine;
- (ii) The phrase “near the engine” is addressing those (parts of) wing fuel tanks as defined in AMJ 20- 128A, figure 2, minimum distance of 10 inches (254 mm) from potential ignition sources of the engine nacelle.

(b) For aircraft with fuselage mounted engines, the phrase “near the fuselage” is addressing those (parts of) wing fuel tanks located inboard of the landing gears.

(3) Fuel tank internal boundaries

Any internal barrier to free flow of fuel may be considered as a solid pressure barrier provided:

- (a) It can withstand the loads due to the expected fuel pressures arising in the conditions under consideration; and
- (b) The time “T” for fuel to flow from the upstream side of the barrier to fill the cell downstream of the barrier is greater than 0.5 second. “T” may be conservatively estimated as,

$$T = \frac{V}{\sum_{i=1}^j C_{di} a_i \sqrt{2g h_i K}}$$

where:

- V = the volume of air in the fuel cell downstream of the barrier assuming a full tank at 1g flight conditions. For this purpose a fuel cell should be considered as the volume enclosed by solid barriers. In lieu of a more rational analysis, 2% of the downstream fuel volume should be assumed to be trapped air;
- j = the total number of orifices in baffle rib;
- C_{di} = the discharge coefficient for orifice i. The discharge coefficient may be conservatively assumed to be equal to 1.0 or it may be rationally based upon the orifice size and shape;
- a_i = the area for orifice i;

- g = the acceleration due to gravity;
- h_i = the hydrostatic head of fuel upstream of orifice i , including all fuel volume enclosed by solid barriers;
- K = the pressure design factor for the condition under consideration.

– END –

EQUIVALENT SAFETY FINDING	E-10 ESF: Fuel tank access covers
APPLICABILITY:	A380
REQUIREMENTS:	JAR 25.963 (g)
ADVISORY MATERIAL:	ACJ 25.963(g)

BACKGROUND

Airbus has requested an Equivalent Safety Finding to JAR 25.963(g) at change 15, as interpreted with ACJ 25.963(g), and proposes to show compliance to JAR 25.963(g) by using the harmonised interpretative material concerning impact resistance, agreed between JAA and FAA as established within the ARAC General Structures Harmonisation Working Group.

The fuel tank access doors impact resistance as harmonised between JAA and FAA, and ACJ 25.963(g) at Change 15 are similar and have the same intent. Major difference is the precise description of test criteria which is to be used in the absence of more rational method.

However, the full harmonised package does not consist solely of the impact resistance subject. In addition, fire resistance is addressed in the harmonised requirement. Considering that a more severe fire resistance requirement is technically applicable to A380 Type Certification through current FAA certification basis, whether or not the full harmonised package is included in JAA Certification Basis, the JAA team believes that the inclusion of the full harmonised package in A380 JAA certification basis should not create any additional burden to the applicant, and would greatly increase the level of harmonisation between A380 JAA and FAA certification basis, by possibly decreasing the number of Significant Regulatory Differences.

EQUIVALENT SAFETY FINDING

In lieu of paragraph (g) of § 25.963 “Fuel tanks: general” the following apply:

Fuel tank access covers must comply with the following criteria in order to avoid loss of hazardous quantities of fuel:

- (1) All covers located in an area where experience or analysis indicates a strike is likely must be shown by analysis or tests to minimise penetration and deformation by tire fragments, low energy engine debris, or other likely debris.
- (2) All covers must have the capacity to withstand the heat associated with fire at least as well as an access cover made from aluminium alloy in dimensions appropriate for the purpose for which they are to be used, except that the access covers need not be more resistant to fire than an access cover made from the base fuel tank structural material.

INTERPRETATIVE MATERIAL

The following means of compliance are provided:

IMPACT RESISTANCE. All fuel tanks access covers must be designed to minimise penetration and deformation by tire fragments, low energy engine debris, or other likely

debris, unless the covers are located in an area where service experience or analysis indicates a strike is not likely. The rule does not specify rigid standards for impact resistance because of the wide range of likely debris which could impact the covers. The applicant should, however, choose to “minimise penetration and deformation” by analysis or test of covers using debris of a type, size, trajectory and velocity that represents conditions anticipated in actual service for aeroplane model involved. There should be no hazardous quantity of fuel leakage after impact. It may not be practical or even necessary to provide access covers with properties which are identical to those of the adjacent skin panels since the panels usually vary in thickness from station to station and may, at certain stations, have impact resistance in excess of that needed for any likely impact. The access covers, however, need not be more impact resistant than the average thickness of the adjacent tank structure at the same location, had it been designed without access covers. In the case of resistance to tire debris, this comparison should be shown by tests or analysis supported by test.

In the absence of a more rational method, the following may be used for evaluating access covers for impact resistance to tire and engine debris.

Tire Debris - Covers located within 30 degrees inboard and outboard of the tire plane of rotation, measured from centre of tire rotation with the gear in the down and locked position and the oleo strut in the nominal position, should be evaluated. The evaluation should be based on the results of impact tests using tire tread segments equal to 1 percent of the tire mass distributed over an impact area equal to 1½ percent of the total tread area. The velocities used in the assessment should be based on the highest speed that the aircraft is likely to use on the ground under normal operation.

Engine Debris - Covers located within 15 degrees forward of the front engine compressor or fan plane measured from the centre of rotation to 15 degrees aft of the rearmost engine turbine plane measured from the centre of rotation, should be evaluated for impact from small fragments. The evaluation should be made with energies referred to in AC 20-128A, Design Considerations for Minimising Hazards Caused by Uncontained Turbine Engine and Auxiliary Power Unit Rotor and Fan Blade Failure. The covers need not be designed to withstand impact from high energy engine fragments such as engine rotor segments or propeller fragments. In the absence of relevant data, an energy level corresponding to the impact of a 3/8 inch cube steel debris at 700fps, 90 degrees to the impacted surface or area should be used.

(For clarification, the word “engines” as used in this interpretative material is intended to include engines used for thrust and engines used for auxiliary power, APU.)

RESISTANCE TO FIRE. Fuel tank access covers meet the requirements of JAR 25.963 (g)(2) above if they are fabricated from solid aluminium or titanium alloys, or steel. They also meet the above requirement if one of the following criteria is met.

The covers can withstand the test of AC 20-135, Powerplant Installation and Propulsion System Component Fire Protection Test Methods, Standards, and Criteria, issued 2/9/90, or ISO 2685- 1992(E), Aircraft - Environment conditions and test procedures for airborne equipment - Resistance to fire in designated fire zones, for a period of time at least as great as an equivalent aluminium alloy in dimensions appropriate for the purpose for which they are used.

The covers can withstand the test of AC 20-135, Powerplant Installation and Propulsion System Component Fire Protection Test Methods, Standards, and Criteria, issued 2/9/90, or ISO 2685- 1992(E), Aircraft - Environment conditions and test procedures for airborne

equipment - Resistance to fire in designated fire zones, for a period of time at least as great as the minimum thickness of the surrounding wing structure.

The covers can withstand the test of AC 20-135, Powerplant Installation and Propulsion System Component Fire Protection Test Methods, Standards, and Criteria, issued 2/9/90, or ISO 2685- 1992(E), Aircraft - Environment conditions and test procedures for airborne equipment - Resistance to fire in designated fire zones, for a period of 5 minutes. The test cover should be installed in a test fixture representative of actual installation in the aeroplane. Credit may be allowed for fuel as a heat sink if covers will be protected by fuel during all likely conditions. The maximum amount of fuel that should be allowed during this test is the amount associated with reserve fuel. Also, the static fuel pressure head should be accounted for during the burn test. There should be no burn-through or distortion that would lead to fuel leakage at the end of the tests; although damage to the cover and seal is permissible.

– END –

EQUIVALENT SAFETY FINDING	E-11 ESF: Rolls-Royce Trent turbine overheat detection
APPLICABILITY:	A380
REQUIREMENTS:	JAR 25.1203 (d)
ADVISORY MATERIAL:	N/A

BACKGROUND

JAR 25.1203(d) states "there must be means to allow the crew to check, in flight, the functioning of each fire or overheat detector circuit".

The turbine overheat detection portion of the Airbus A380 with Trent 900 design, as presently configured, does not allow the crew to check its functioning during flight. Although the fire zone compartment detector portion of the fire/overheat system can be fully tested in flight, and complies with JAR 25.1203(d), the inability to test the turbine overheat detection circuit in flight does not satisfy the testing provisions of this rule.

Airbus proposes to show an equivalent safety finding to JAR 25.1203 (d) for the turbine overheat detection system.

CONCLUSION

The turbine overheat detection system installed on the Rolls Royce Trent 900 engines fitted on A380 aircraft ensures that the turbine does not overheat in case of failure of the internal cooling air system.

This system is comprised of 4 thermocouples:

- 2 at the rear of the HP disc to protect the HP and IP turbines from failure of the HP3 cooling air system
- 2 at the front of the LP disc to protect the LP turbine from failure of the IP8 cooling air system.

One of the forward and one of the rearward thermocouples are linked to each EEC (Engine Electronic Control) channel. The EEC is in turn linked to the Flight Warning System (FWS) to generate a warning to the cockpit (with associated procedure), if an overheat is detected by the thermocouples.

The condition of the turbine overheat detection system is continuously monitored by the EEC from power-up. Any system fault generates a maintenance message. Flight deck effect will depend on the detected fault and associated dispatch condition:

- If faults affecting only one channel are detected, then a cockpit message associated with a limited dispatch condition will be triggered.
- If faults affecting both channels are detected, then a cockpit message associated with a DO NOT DISPATCH condition will be triggered.

Based on the system design, Airbus considers that the intent of JAR 25.1203 (d) is met. There is no need on the A380 to provide a means to allow the flight crew to be able to directly check the turbine overheat system's functioning in flight.

The JAA team is satisfied that the design features of A380 Turbine overheat detection system comply with the intent of JAR 25.1203(d).

– END –

EQUIVALENT SAFETY FINDING	E-12 ESF: GP7200 Fan zone as a non fire zone
APPLICABILITY:	A380
REQUIREMENTS:	JAR 25.1181 (a)
ADVISORY MATERIAL:	N/A

BACKGROUND

JAR 25.1181 provides the definition of designated fire zones. JAR 25.1181(a)(6) indicates this include the compressor section of turbine engines. The fan section is a compressor section of a turbine engine. JAR 25.1181(b) identifies the requirements which a fire zone must meet (25.867, 25.869, and 25.1185 to 25.1203).

The fan zone of the GP7200 has not been classified by Airbus as a designated fire zone.

Airbus should justify that any requirement applicable to designated fire zones, which the fan zone of the GP7200 installation does not meet, are compensated by factors which provide an equivalent level of safety, according to the provision of JAR 21.21(c)(2).

CONCLUSION

Rationale for GP7200 Fan Zone as a non fire zone:

On the GP7200, the compressor is NOT classified as a designated fire zone and thus does not contain a fire detection and extinguishing system. This zone (compressor), however, still meets the intent of JAR 25.1181(a)(6) as its architecture and operating environment inherently protects against the start and continued propagation of a fire. This inherent protection provides an equivalent level of safety to those areas classified as a designated fire zone and containing a fire detection and extinguishing system.

The GP7200 compressor zone architecture ensures the segregation of flammable fluid, hot air or component surfaces and electrics. The objective of this segregation is to ensure the ignition source does not come in contact with the flammable fluid or vapour.

The fan zone is divided into wet and dry sides with the following main components:

- Dry side: FADEC, Vibration monitoring unit (VMU), Nacelle anti-ice pipe, ignition exciter boxes and leads, electrical harnesses, Powered Cowl Opening (PCOS), FADEC pressure sense lines, Electrical Thrust Reverser Actuation System (ETRAS): Power Drive Unit (PDU), Electrical Thrust Reverser Actuation Computer (ETRAC), TRPU (T/R power unit, electrical converter a/c to ETRAS), Primary lock system (PLS), Tertiary Lock System (TLS)
- Wet side: Oil tank and lines, hydraulic lines (case drain line & filter, low pressure), PCOS, PLS, electrical harnesses.

Airbus considers that the GP7200 fan zone layout provides compensating factors to demonstrate an equivalent level of safety to those areas classified as a designated fire zone.

The GP7200 has flammable fluid lines equivalent to those found in a designated fire zone. The design and construction of the GP7200 fan zone flammable fluid lines and tank (oil) meet the requirements of JARE 530 / FAR33.17. Consequently flammable fluid carrying components are fire resistant and located or protected such that they are not potential ignition sources (external temperature under flammable fluid ignition point). Tank and supports are designed to be fireproof; only an oil tank is fitted in the GP 7200 fan zone.

The GP7200 precludes the risk of hot air leaks and hot surfaces above the flammable fluid auto ignition temperature by using design precautions. The hot air leaks are precluded for the nacelle anti-ice pipe and valve located on the lower part of the dry side by a double wall design. A thermal blanket covers the hot surfaces and maintains the skin temperature below the flammable fluid ignition temperature.

The GP7200 precludes ignition sources by qualifying the electrical systems, harnesses and connector explosion proof (cat E or H as per RTCA DO-160D/ED-14D). In case of fluid leakage, the segregation is maintained by an adequate drainage and ventilation of the zone. The flammable fluids are drained overboard at the bottom of the compartment (6 o'clock). The drainage system is sized to avoid fluid hazardous accumulation in the zone. The flammable fluid vapours are ventilated by an inlet scoop at 3 O'clock to an exit at 6 O'clock.

These design precautions preclude the initiation of a fire and are thus providing an equivalent safety level to a designated fire zone.

JAA accepted a demonstration of equivalent level of safety to JAR 25.1181(a)(6) and 25.1181(b), based on the rationale above mentioned.

– END –

EQUIVALENT SAFETY FINDING	E-15 ESF: Warning means for Engine Fuel Filters
APPLICABILITY:	A380
REQUIREMENTS:	JAR 25.1305(c)(6) (as required by NPA 25E-315) and JAR 25.997(d)
ADVISORY MATERIAL:	N/A

BACKGROUND

The A380 Trent 900 engine incorporates a dual filtering system :

- one main LP filter, located between fuel tank outlet and inlet of engine high pressure pump stage, and having a dedicated bypass with cockpit indication (FUEL FILTER CLOG).
- one HP filter, located after the high pressure pump before the burners, and having neither bypass nor cockpit indication.

The fuel filtration system does not directly comply with the provisions of JAR 25.1305(c)(6) section, as introduced by the NPA 25 E-315, and which is included in JAR-25 at change 16 dated 1st May 2003. JAR.25.1305(c)(6) at change 16 is part of the A380 certification basis, following Airbus decision to elect to comply with change 16 paragraphs introduced by NPA 25 E 315, for the purpose of harmonization of FAA and JAA certification bases.

JAR / FAR 25.1305(c)(6) requires an indicator for the fuel strainer or filter required by § 25.997, to indicate the occurrence of contamination of the strainer or filter before it reaches the capacity established in accordance with 25.997(d).

JAR / FAR 25.997 requires a fuel strainer or filter between the fuel tank outlet and the inlet of either the fuel metering device or an engine driven positive displacement pump, whichever is the nearer of the fuel tank outlet.

Compliance with JAR 25.1305(c)(6) or demonstration of an equivalent safety finding is required to approve the proposed configuration.

CONCLUSION

The LP fuel filter fully complies with JAR / FAR 25.1305(c)(6) requirements. It has a 95% efficiency at 10 microns and 100% efficiency at 40 microns. It is the primary source of protection from debris residing in the supply fuel / wing fuel system. Its bypass valve setting is 25psid, with its impending blockage warning set at 8.5psid.

The HP fuel filter has been introduced to improve safety levels by protecting the engine fuel burners from debris (as required by JAR-E 560(f)), which may be generated downstream of the LP filter (as a result of a pump mechanical failure or degradation) within a given engine. The filter is sized at 250 microns, to arrest particles that may block the burners and are of much greater size than those considered for the LP filter. Blockage of the fuel burners may lead to an inadequate distribution of the fuel flow into the combustor and possibly result in a casing burn through.

Airbus considers that the HP filter is not strictly required by JAR / FAR 25.997, and shall not comply with the provisions of JAR / FAR 25.1305(c)(6).

However, the fuel filtering system provides following factors that substantiate an improved level of safety with that HP filtering not having a bypass :

- The impending bypass of the main LP fuel filter is indicated by an amber warning (ENG X FUEL FILTER CLOG) on ECAM E/WD and by a CLOG indication on ECAM ENGINE SD, that puts the aircraft in an MMEL situation at next landing. The fuel filter must be changed before dispatch. An audio chime also accompanies the ECAM warning.
- Even though the HP fuel filter does not have an indication of clogging, it is considered that this filter improves the minimum safety level warranted by the literal compliance with § 25.1305(c)(6). Blockage of this filter may occur due to a contamination of the engine fuel system itself and lead at worst to a complete single engine thrust loss. The same type of contamination in the engine fuel system not equipped with such a filter but fully compliant with § 25.997 would result in an engine casing burn through which is considered to have more adverse consequences on the aircraft than a single engine thrust loss.
- Tests performed for Engine type certification, as part of demonstration of compliance with JARE-560 & E-670, shall show that even in case of LP filter bypass operation, the HP filter is not susceptible to blockage. In-service experience of the Rolls-Royce RB211 engines (which include the Trent family and exceed 100 million engine operating hours) confirm that the HP filter is not susceptible to blockage under normal engine operation.
- The maintenance procedure associated with a blocked LP filter includes checking of the HP filter.

Airbus considered, based on the rationale above mentioned that the Trent 900 engine fuel filtering system is compliant with the minimum level of safety required by JAR 25.1305(c)(6) and JAA accepted this demonstration.

– END –

EQUIVALENT SAFETY FINDING	E-16 ESF: Thrust reverser testing
APPLICABILITY:	A380
REQUIREMENTS:	JAR 25.934 and JAR-E 890
ADVISORY MATERIAL:	N/A

BACKGROUND

The A380, equipped with Rolls-Royce Trent 900 or Engine Alliance GP7200 engines, is having thrust reversers on internal engines only.

JAR 25.934 requires that the “thrust reversers installed on turbo-jet engines must meet the requirements of JAR-E 890” which deals with thrust reverser testing.

JAR E.890 (b) requests that "The thrust reverser shall be fitted to the Engine for the whole of the Endurance Test of JAR-E 740 and a representative control system shall be used".

However, both engine manufacturers do not intend to install the A380 thrust reverser unit during their Engine type certification 150h Endurance test requested by JAR-E 890, but will use slave C-ducts.

Similar situations have occurred on other large transport aircraft, usually resulting from the thrust reverser being an airframe part not supplied by the engine manufacturer.

Airbus shall therefore present an Equivalent Safety Finding to demonstrate compliance with JAR 25.934 regarding the thrust reverser test.

EQUIVALENT SAFETY FINDING

1. Forward testing part

Both Engine manufacturers do not intend to demonstrate strict compliance with JAR-E 890 requirements for the forward mode testing part. Indeed, both Engine manufacturers shall use slave C-ducts instead of a real A380 thrust reverser for the engine JAR-E 740 endurance certification test. The intent for this test is indeed to have as much flexibility as possible to adapt the nozzle size and thus reach the engine redlines (LP, IP (RR engine) and HP shaft rotational speeds + TGT).

Both Engine manufacturers and their Engine Airworthiness Authorities have agreed that slave C-ducts with aerodynamic and mechanical characteristics equivalent to those of a real thrust reverser cannot have a worse effect on the engine functioning.

Therefore, the evaluation of the impact of the engine functioning on the stowed thrust reverser, as required by JAR-E 890 requirements, will be based on use of other engine service readiness endurance testing.

Airbus, associated with Engine and Nacelle manufacturers, have defined an acceptable endurance cycle format to demonstrate that: - the time spent at maximum level of thrust will be at least equivalent to the one for JAR-E 740 endurance test - the number of accelerations / decelerations from extreme levels of thrust will be at least equivalent to the one for JAR-E 740 endurance test

Details of the cycle format and comparison versus JAR-E 740 requirements will be presented in the “Thrust reverser compliance with JAR 25.934 - test plan” 00L710VRR28/P04 (T900 engine) and 00L710VGP28/P04 (GP7200 engine).

2. Reverse testing part

For both engine manufacturers, the same thrust reverser unit that had performed the forward thrust endurance testing, will be installed on an engine in order to perform the 200 reverse cycles required by JAR-E 890 requirements.

Complete substantiation for compliance with JAR 25.934 shall be detailed in certification documents. Those documents will include test plan and report for complete compliance with JAR-E 890 requirements applicable for each engine.

Based on the above rationale, A380 JAA Powerplant panel agrees that an Equivalent Safety Finding to JAR 25.934 could be accepted provided Airbus, with the support of Engine and Nacelle manufacturers, can show that the A380 thrust reverser as installed on the Rolls-Royce Trent 900 or on the Engine Alliance GP7200 engine will meet the intent of JAR 25.934:

- The stowed and deployed thrust reverser does not adversely affect the correct functioning of the engine,
- The stowed and deployed thrust reverser is not adversely affected by engine functioning.

This should be demonstrated for all engine settings and operating conditions, and throughout the full flight envelope.

Since the Thrust Reverser test, as required by JAR 25.934 and subsequently JAR E.890(b), is not covered by the JAA Engine Type Certification, the A380 JAA Powerplant panel will be involved in the forward and reverse endurance testing for both engine types as described in the above plan outlined by Airbus.

– END –

EQUIVALENT SAFETY FINDING	E-17 ESF: Oil temperature indication
APPLICABILITY:	A380
REQUIREMENTS:	JAR 25.1549
ADVISORY MATERIAL:	N/A

BACKGROUND

JAR 25.1549(a) requires that each maximum safe operating limit must be marked with a red radial or a red line. Although written for conventional indicators, this has been generally applied to digital CRT indications by using a color-coding consistent with the conventional indicators.

NB: CRT technology is now replaced by LCD technology on A380.

The A380 engine oil temperature is displayed on the ECAM (Electronic Centralized Aircraft Monitoring) display screen. The indication is provided in digital form:

- it is normally green
- it pulses green if the temperature exceeds a limit threshold (under definition with both engine manufacturers),
- it turns amber if the temperature exceeds that limit threshold for more than 15 minutes or the maximum oil temperature indicated by the engine manufacturer without delay.

The Airbus Oil temperature indication on ECAM therefore does not literally comply with JAR 25.1549(a), which would require the indication to turn red instead of amber when the maximum limit is exceeded.

Therefore, an Equivalent Safety Finding is required.

EQUIVALENT SAFETY FINDING

Airbus current practice for Engine oil temperature indication is to have green digits for normal range, flashing green digits between steady state and transient declared (Engine TCDS) limits when duration is below declared time limit, and steady amber digits above the declared time limit and when oil temperature is beyond transient limit. Such display is already into service on all other Airbus applications.

To support the Equivalent Safety Finding, Airbus presented the following comments:

- Requesting such a change, based on JAR 25.1549, represents an extension of what is strictly required in the regulation (see JAR 25.1549 wording) as this JAR 25 paragraph is specifically written for clock and band indicators.
- A digit colour change and a needle reaching a red bordered sector have not the same psychological impact on the crew (red digits are more "demanding").
- The colour coding of CRT/LCD indications/warnings is addressed in AMJ 25-11. This mentions that deviations to the recommended colour coding may be approved with acceptable justifications (§ 5(a)).
- The exceedance of the maximum oil temperature limit does not require an immediate action from the crew. This had been justified by the airframe and engine manufacturers and accepted both by the airframe and engine certification specialists complemented, for both Rolls Royce Trent 900 and Engine Alliance GP7200.

- The exceedance of the maximum oil temperature limit is signalled, in addition to the amber indication on the ECAM, by an amber master caution located in each pilot field of view associated with a single aural chime (inhibited during critical flight phases such as take-off). This amber caution triggers an ECAM message indicating the nature of the malfunction (Oil Temperature High) and the associated procedure (reduce power and shut down the engine if it is not possible to maintain the oil temperature below the limit). JAR 25.1305, which lists the required powerplant instruments and warnings, requires an oil pressure warning and an oil temperature indicator, but does not require an oil temperature warning or caution. The current design therefore exceeds the current JAR 25 requirements by providing an unmistakable indication to the crew in case of oil temperature exceedance.
- Besides, the sudden arrival on ECAM of red digits during take-off flight phases (even with the associated master caution signal inhibited) may lead to an increased rate of undue rejected take-offs, which cannot be considered as desirable.
The possibility of such a problem regarding rejected take-offs is supported by the content of the Interpretative Material provided in ACJ to JAR 25.1549, which in relation to a requirement specifically dedicated to indications, states that: "... the colour red indicates an unsafe condition which requires immediate and precise action by the flight crew...".

EASA considered that the A380 engine oil temperature indication as displayed on the ECAM is not strictly compliant JAR 25.1549(a). However, EASA considered that there are grounds to justify that the current design is acceptable and provides an equivalent level of safety to JAR 25.1549(a).

– END –

EQUIVALENT SAFETY FINDING	E-19 ESF: Engine fuel filter location
APPLICABILITY:	A380
REQUIREMENTS:	JAR 25.997
ADVISORY MATERIAL:	N/A

BACKGROUND

JAR 25.997 requires that there must be a fuel strainer or filter between the fuel tank outlet and the inlet of either the fuel metering device or an engine driven positive displacement pump, whichever is nearer the fuel tank outlet.

JAR 25.997 requires there must be a fuel strainer or filter between the fuel tank outlet and the inlet of either the fuel metering device or an engine driven positive displacement pump, whichever is nearer the fuel tank outlet. In addition, that requirement is highly similar to the engine certification requirement FAR 33.67(b).

JAR 25.1305(c)(6) requires that an indicator for the fuel strainer or filter required by JAR 25.997 to indicate the occurrence of contamination of the strainer or filter before it reaches the capacity established in accordance with JAR 25.997(d).

The proposed design for the GP 7200 design does not feature a fuel filter upstream of the fuel pump. There is however a fuel strainer at the inlet of the pump, but it does not meet the requirements for the fuel filter required by 25.997.

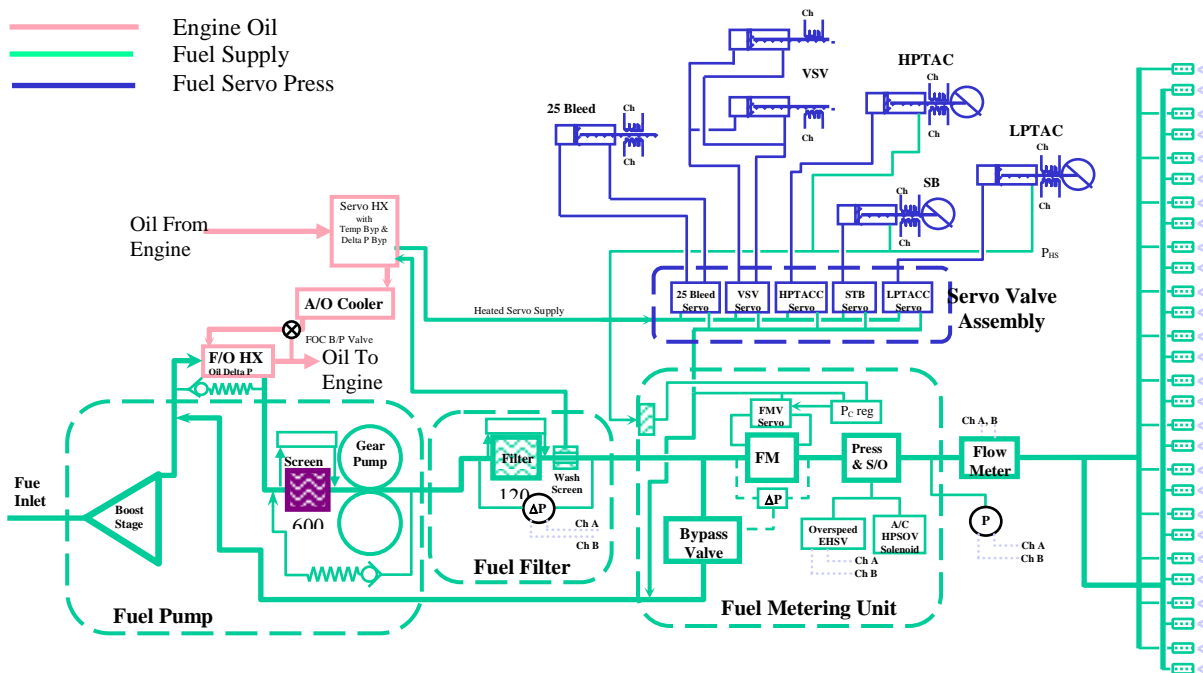

The proposed design is not compliant to JAR 25.997 and JAR 25.1305(c)(6). Airbus and Engine Alliance should propose a revised design or justify an equivalent level of safety.

EQUIVALENT SAFETY FINDING

Aircraft fuel system description

The aircraft fuel system is equipped in the wing fuel tank with a wire mesh, located just upstream the tank cell boost pump dedicated to one engine. That wire mesh is rated is 3,500 microns absolute and does not include a bypass. It prevents coarse particles to enter in the fuel pylon line down to the engine fuel inlet.

Engine fuel system description

The GP7200 fuel system, including its filtration methodology, is described and analysed in Engine Alliance GP7200 Fuel System Report, and has been reviewed with FAA Engine Airworthiness Authorities, and shown compliant during Engine Type Certification exercise, granted on December 29, 2005.

The GP7200 main fuel pump includes an inter-stage strainer located between its centrifugal boost stage and its positive displacement gear stage. All fuel entering the gear stage passes through this strainer. It is rated 600 microns absolute and includes a bypass valve so that it should never restrict fuel flow. All fuel delivered to the engine from the aircraft and all fuel re-circulated within the engine's fuel system passes through this strainer before entering the positive displacement, gear stage of the fuel pump. The fuel flow exits the main fuel pump flows through the main fuel filter before entering the fuel metering system. The fuel metering system is the FMU. The main fuel filter is rated 35 microns absolute and includes a bypass valve with remote indication in the cockpit. It filters all fuel entering the fuel-metering valve. That supports compliance with JAR 25.997.

Compliance demonstration to JAR 25.997 and JAR 25.1305(c)(6)

Compliance to the above mentioned Aircraft regulations is demonstrated via the following features of the aircraft / engine system.

Compliance with JAR 25.997(a) – equivalent to FAR 33.67(b)(1) :

The inter-stage strainer is an integral part of the main fuel pump. It filters all fuel entering the fuel pump's gear stage. It is located on the bottom side of the pump, as installed on the engine. This location allows easy access to the strainer for inspection, cleaning or replacement. The strainer includes an adjacent drain plug, which allows the strainer to be drained prior to maintenance. The strainer is attached to the main fuel pump with three ¼ inch bolts. The bolts are readily accessible. This allows easy removal of the strainer.

The main fuel filter is mounted on the main fuel pump. It filters all fuel flow before entering the fuel-metering unit. It mounts on the bottom, outboard side of the fuel pump as installed on the engine. This location allows easy access to the filter for inspection, cleaning or element replacement. The filter includes an integral drain plug, which allows the filter bowl to be drained prior to maintenance. The fuel filter is bolted to an adapter on the main fuel pump housing. The filter bowl, which contains the filter element, is threaded into the filter head assembly. This allows easy removal of the filter bowl to replace or inspect the filter element.

Compliance with JAR 25.997(b) – equivalent to FAR 33.67(b)(2) :

The fuel filter slopes downward at about 15° angle relative to horizontal on engine. Fuel enters the main fuel pump at the top as installed on engine, flows into the filter bowl and then flows radially inward through the filter element. Contaminants are trapped on the outside of the filter element. If contaminants fall from the outer surface of the filter element, they will collect in the bottom of the filter bowl, which serves as a sediment trap. The filter includes a drain plug located at the bottom of the filter head.

Fuel enters the inter-stage strainer at the top as installed on the engine, flows into the ID of the strainer element and then flows radially outward through the strainer element. Contaminants are trapped on the inside of the strainer element. If contaminants fall from the inner surface of the strainer element, they will collect in its bottom, which serves as a sediment trap. The strainer includes a drain plug at the bottom of its housing.

Compliance with JAR 25.997(c) – equivalent to FAR 33.67(b)(3) :

Both interstage strainer and fuel filter are mounted on the main fuel pump. The inter-stage is installed with three ¼ inch bolts, and the fuel filter is installed with six 3/8 inch bolts and one 3/8 inch stud. Such installation is similar to other GE applications

Compliance with JAR 25.997(d) – equivalent to FAR 33.67(b)(5) :

Purpose of the inter-stage strainer is not to provide a filtration of sustained fuel contamination but to block large objects from passing through the Main Fuel Pump gear stage; Sustained fuel contamination is captured by the Main Fuel Filter that is located just after the Main Fuel Pump gear stage, and before the Fuel Metering Unit.

Dedicated engine testing has been completed to demonstrate the capability of the pump to operate nominally with contaminated fuel : fuel pump has demonstrated a satisfactory operation during 300 hours with contaminants up to 200µm at 8g / 1000 USG, as specified by AI. This level was recognised for engine type certification as the maximum quantity of solid contaminants likely to be encountered in service

Compliance with JAR 25.1305(c)(6) – equivalent to FAR 25.1305(c)(6) :

The inter-stage strainer is fitted with a bypass without any indication to the cockpit. The main fuel filter, located downstream the positive displacement gear stage pump, is fitted with a bypass, that is indicated to the cockpit through a caution and an ECAM display.

For existing defined contamination levels, as the inter-stage strainer sizing is far larger than the main fuel filter sizing, the clogging of the main fuel filter will occur before the inter-stage strainer, which supports the no-necessity of any bypass indication on the inter-stage strainer.

For the same reason, it is also expected that any (unlikely) sustained contamination that could block the pump strainer and prompt its bypass operation would almost immediately generate impending blockage indication of the main fuel filter. Operation of the positive displacement pump with fuel contaminants greater than 600 microns would therefore be very limited. The robustness of the pump design demonstrated by both the severe fuel contaminated testing performed for the GP7200 application as well as the extensive in-service experience with similar design on GE engines gives reasonable confidence that the pump will be able to properly function with bypass contaminated fuel for such a limited period.

Engine Alliance (GE) has indeed accumulated 284 million engine hours of operation with a filter located downstream the positive displacement gear stage pump (as GE CF6 / GE90 engines types). That in-service experience records 955 fuel contamination events, none of which resulted in an IFSD from filter clogging or other obstruction of fuel flow, nor caused pump failure or a hazard to the aircraft.

In addition, Engine Alliance (GE) experience with a filter located upstream the positive displacement gear stage pump (i.e. CFM56 engine types) show similar behavior. Therefore, location of filter upstream the positive displacement gear stage pump is no more likely to result in IFSD, power loss, fuel pump failure or hazard to the aircraft further to a fuel contamination.

For Aircraft Type Certification, a CMR** will be included in the maintenance program to systematically check the engine fuel pump inter-stage strainer for signs of potential contamination every 750fh of operations. AI consider that the strong evidences of the engine fuel system design robustness (provided to EASA/FAA at issue 1 of the CRI/Stage 3 of the IP position), combined with the limited risk of feul system interventions during the proposed interval (no scheduled task or checks apart from the visual overall leak check to be performed every 48 hours and the water drain valve actuation to be performed on a weekly basis as per the MPD) fully supports this proposal

Post-Aircraft Type Certification, design modifications will be incorporated in order to provide an indication (cockpit or maintenance) of impending bypass operation of the engine fuel pump inter-stage strainer.

- Post aircraft-TC, the engine fuel pump strainer will be modified to incorporate a delta P transducer of similar design to the one already fitted on the main fuel filter.
- This delta P transducer will transmit a signal to the FADEC which in turn will send a signal to the FWC for cockpit indication (and associated MMEL dispatch relief) as detailed below

Strainer Status	Filter Status (1)	CMS Message	FWC Message
Impending Bypass (12 psid < DP) (Single Engine)	Clean filter or Approaching Bypass (DP < 35psid)	Strainer Maintenance	None (Class 4 : 500 Hrs dispatch time)
Impending Bypass (12 psid < DP) (Dual Engine)	Clean filter or Approaching Bypass (DP < 35psid)	Strainer Maintenance	ENG X FUEL STRAINER CLOG (one caution per affected engine) (Class C : 2 x 10 day dispatch time)
Impending Bypass (12 psid < DP) (Single Engine)	Impending Bypass (35psid < DP)	Strainer Maintenance and Filter Maintenance	ENG X FUEL SYS CONTAMINATION (NO GO)

The absence of validated signal from the strainer transducer will be handled as follows by the FADEC and FWC

Fault Condition	FWC Message
Soft Sensor Fault <i>(disagreement between channels)</i>	None (Class 4 : 500 Hrs dispatch time)
Single Channel Sensor Fault	None (Class 4 : 500 Hrs dispatch time)
Dual Channel Sensor Fault	ENG X FUEL FILTER MONITORING FAULT ⁽¹⁾ (Class C: 2 x 10 day dispatch time)

- The intention is to incorporate the necessary design changes for the delivery of the first aircraft with GP7200 engines (MSN011). There is a small risk that this target is missed. In such a case, AI will retrofit this aircraft with the modified design at the latest during the first scheduled maintenance task on the engine (i.e. after 750FH). All subsequent aircraft equipped with GP7200 engines will be delivered with the modified design (i.e. deltaP transducer fitted on the strainer)

Based on the above, Airbus requested:

- An ESF for the TC design (no strainer monitoring) based on the definition of a CMR as detailed in AI position at issue 2
- An ESF for the modified design including a strainer bypass monitoring (by means of a delta P transducer) and associated cockpit indications as described above.

EASA agreed that both Equivalent Safety Findings are adequately justified.

– END –

EQUIVALENT SAFETY FINDING	E-20 ESF: Fire Extinguishing Agent Concentration
APPLICABILITY:	A380
REQUIREMENTS:	CS 25.1195(c)
ADVISORY MATERIAL:	AMC 25.1195(b), AC 20-100

BACKGROUND

CS 25.1195(c) requires that a nacelle fire extinguishing system be able to simultaneously protect each zone of the nacelle for which protection is provided. Associated Interpretative Material is giving information on the required agent concentration to be maintained as well as the required presence time of this concentration (see AMC 25.1195 (b) that calls AC 20-100).

The Rolls-Royce Trent 900 engine that is installed on the A380 features three Designated Fire Zones (DFZ). Each DFZ is physically separated from the other by firewalls (CS25.1191).

Rolls-Royce intends to implement the modification 74461 on the turbine case cooling valve of the Trent 900 engine in order to improve turbine efficiency. This modification would increase the ventilation airflow in Designated Fire Zone (DFZ) number 3 (core compartment) which would have an impact on fire extinguishing agent concentration. So this modification will require demonstration of compliance with JAR 25.1195(c).

For this engine, fire extinguishing protection will be provided for all DFZ. This protection will be simultaneous in the sense that extinguishing agent will flow to each DFZ as a result of the same unique action. However the extinguishing system will be constructed so that the required minimum agent concentration may not be present during 0.5s (as indicated in the AC 20-100) across all areas of all DFZ. The 0.5 s criterion will be met in each DFZ separately.

Airbus requested an Equivalent Safety Finding with respect to fire extinguishing concentration compliance with JAR 25.1195 (c).

EQUIVALENT SAFETY FINDING

The engine fire extinguishing system as defined for the A380 is considered to meet the intent of CS 25.1195(c) and to provide the necessary level of safety for the reasons detailed hereafter:

1. There is a unique agent discharge action that will ensure flowing of the agent towards all three nacelles zones
2. Each DFZ, individually considered, have all its portions simultaneously protected as per the AC 20-100 0.5s minimum agent concentration presence time criterion.
3. The DFZ is separated by firewall constructions demonstrated compliant to CS 25.1191(b) ensuring no hazardous quantity of fluid, air or flame can pass from the compartment to other zone. This has been demonstrated to EASA by design description, nacelle inspection and drainage flight testing. An acceptable pass-fail criterion for this flight testing is: cross-contamination between different zones is limited to isolated droplets (fluid dribbles) and limited continuous thin lines of fluid (fluid trickles); continuous fluid path from a fire zone to another is not acceptable.

4. As on previous programs, maintenance instructions are be defined and provided to the operators, as part of the Instructions for Continued Airworthiness (ICA), with the objective to ensure that the firewall integrity is maintained throughout the operational life of the nacelle.
5. Airbus has no in-service experience of fire propagation from one nacelle zone to the other.
6. Test conducted in the past for fire characterization and development of concentration criteria's (AC 20-100) showed that:
 - a. A key parameter in extinguishing fires is the homogeneity of agent diffusion in the considered nacelle radial section and the rapidity to achieve this diffusion. The AC 20-100 0.5s criterion is particularly meaningful in characterizing this parameter.
 - b. A fire ignited in a section never went through a firewall inducing a fire into another section.
7. In the frame of those tests, FAA stated that [...] 'each fire zone may be treated individually with respect to the "simultaneous" requirement' [...] (ref to report FAA DS 70-3).

– END –

SPECIAL CONDITION and IM	F-01 SC & IM: JAR 25.1301 and 1309 Compliance - Design assurance and safety assessment processes
APPLICABILITY:	A380
REQUIREMENTS:	JAR 25.1301 - 25.1309 (NPA 25F-281)
ADVISORY MATERIAL:	N/A

BACKGROUND

The A380 will introduce an unprecedented use of complex systems and level of integration, like the Integrated Modular Avionics concept.

This increases the potential for common cause failures and for development errors (requirements/design/implementation) for which traditional deterministic techniques for assessing residual errors may not be available.

In order to achieve the required safety objectives, it is then necessary to consider the integration of the individual systems regarding fault propagation/isolation in addition to the traditional approach of addressing each system individually. It is also necessary to consider an aircraft level functional hazard assessment in addition to the system level. Finally, appropriate methods must be established for development assurance levels determination and verification.

NPA 25F-281 issue 3 dated 06/10/98 are more appropriate for the A380 than the existing requirements. This NPA is introduced in the A380 certification basis as a special condition, in accordance with JAR 21.16(a)(1).

This is due to the high level of integration of the A380 systems, and to the fact that the proposed AMJ 25.1309-1, in particular, covers more formally :

- The need for an aircraft level functional hazard assessment in addition to the more traditional system level approach.
- Specific considerations for highly integrated and complex systems.
- The need for specific design assurance methods for complex systems, software and some electronic hardware.
- Consideration of crew/maintenance errors.
- Common cause analysis (zonal safety analysis, particular risk analysis, common mode analysis).
- System Safety Assessment methodology (Aircraft/System FHA/PSSA/SSA...).

SPECIAL CONDITION

1. JAR 25.1301 at change 15 is amended by suppressing the text of sub-paragraph (d) to read as follows:

JAR 25.1301 Function and installation

Each item of installed equipment must:

- (a) Be of a kind and design appropriate to its intended function;
- (b) Be labelled as to its identification, function, or operating limitations, or any applicable combination of these factors. (see ACJ 25.1301 (b)).
- (c) Be installed according to limitations specified for that equipment.

2. JAR 25.1309 at change 15 is amended by revising the title and text to read as follows:

JAR 25.1309 Equipment, systems, and installations

(See AMJ 25.1309-1)

The requirements of this paragraph, except as identified below, are applicable, in addition to specific design requirements of JAR-25, to any equipment or system as installed in the aeroplane. Although this paragraph does not apply to the performance and flight characteristic requirements of Subpart B and the structural requirements of Subparts C and D, it does apply to any system on which compliance with any of those requirements is dependent. Certain single failures or jams covered by JAR 25.671(c)(1) and JAR 25.671(c)(3) are excepted from the requirements of JAR 25.1309(b)(1)(ii). Certain single failures covered by JAR 25.735(b)(1) are excepted from the requirements of JAR 25.1309(b). The failure effects covered by JAR 25.810(a)(1)(v) and JAR 25.812 are excepted from the requirements of JAR 25.1309(b). The requirements of JAR 25.1309(b) apply to powerplant installations as specified in JAR 25.901(c).

- (a) The aeroplane equipment and systems must be designed and installed so that:
 - (1) Those required for type certification or by operating rules, or whose improper functioning would reduce safety, perform as intended under the aeroplane operating and environmental conditions.
 - (2) Other equipment and systems are not a source of danger in themselves and do not adversely affect the proper functioning of those covered by sub-paragraph (a)(1) of this paragraph.
- (b) The aeroplane systems and associated components, considered separately and in relation to other systems, must be designed so that (see AMJ 25.1309(b)).
 - (1) Any catastrophic failure condition
 - (i) is extremely improbable; and
 - (ii) does not result from a single failure; and
 - (2) Any hazardous failure condition is extremely remote; and
 - (3) Any major failure condition is remote.
- (c) Information concerning unsafe system operating conditions must be provided to the crew to enable them to take appropriate corrective action. A warning indication must be provided if immediate corrective action is required. Systems and controls, including indications and annunciations must be designed to minimise crew errors which could create additional hazards.

3. A new JAR 25.1310 is added to read as follows:

JAR 25.1310 Power source capacity and distribution

- (a) Each installation whose functioning is required for type certification or by operating rules and that requires a power supply is an "essential load" on the power supply. The power sources and the system must be able to supply the following power loads in probable operating combinations and for probable durations (see ACJ 25.1310(a)):
 - (1) Loads connected to the system with the system functioning normally.
 - (2) Essential loads, after failure of any one prime mover, power converter, or energy storage device.
 - (3) Essential loads after failure of:
 - (i) Any one engine on two-engined aeroplanes; and
 - (ii) Any two engines on three-or-more engined aeroplanes.

After the failure of any two engines on a three-engined aeroplane, those services essential to airworthiness must continue to function and perform adequately within the limits of operation implied by the emergency conditions. (See ACJ 25.1310(a)(3).)

- (4) Essential loads for which an alternate source of power is required, after any failure or malfunction in any one power supply system, distribution system, or other utilisation system.
- (b) In determining compliance with sub-paragraphs (a)(2) and (3) of this paragraph, the power loads may be assumed to be reduced under a monitoring procedure consistent with safety in the kinds of operation authorised. Loads not required in controlled flight need not be considered for the two-engine-inoperative condition on aeroplanes with three or more engines.
4. JAR 25.1351 at change 15 is amended by revising the txt of sub-paragraph (b)(6) to read as follows:

JAR 25.1351 General

- (b)(6) There are means to indicate to appropriate crew members the generating system quantities essential for the safe operation of the system, such as the voltage and current supplied by each generator (see ACJ 25.1351(b)(6)).

INTERPRETATIVE MATERIAL

5. Delete ACJ No. 2 to JAR 25.1309
6. Delete ACJ No. 3 to JAR 25.1309
7. Delete ACJ No. 4 to 25.1309 and rename it as a new ACJ 25.1351(b)(6):

ACJ 25.1351(b)(6)

Generating System (Acceptable Means of Compliance and Interpretative Material)
See JAR 25.1351(b)(6)
Same content as previous ACJ No. 4 to JAR 25.1309.

8. Delete ACJ No. 6 to JAR 25.1309 and rename it as a new ACJ 25.1310(a):

ACJ 25.1310(a)

Power Source Capacity and Distribution (Acceptable Means of Compliance)
See JAR 25.1310(a)

When alternative or multiplication of systems and equipment is provided to meet the requirements of JAR 25.1310(a), the segregation between circuits should be such as to minimise the risk of a single occurrence causing multiple failures of circuits or power supplies of the system concerned. For example, electrical cable bundles or groups of hydraulic pipes should be so segregated as to prevent damage to the main and alternative systems and power supplies.

9. Delete ACJ No. 7 to JAR 25.1309 and rename it as a new ACJ 25.1310(a)(3):

ACJ 25.1310(a)(3)

Power Source Capacity and Distribution (Interpretative Material)
See JAR 25.1310(a)(3)

Same content as previous ACJ No. 7 to JAR 25.1309.

(Note : not relevant to A3XX as applicable only to three-engined aeroplanes.)

10. Delete ACJ No. 8 to JAR 25.1309

11. Replace AMJ 25.1309 by:

AMJ 25.1309-1
System Design and Analysis
See JAR 25.1309

– END –

SPECIAL CONDITION	F-02 SC: Slide/raft portability
APPLICABILITY:	A380
REQUIREMENTS:	JAR 25.1411(d), 25.1415(b)
ADVISORY MATERIAL:	N/A

BACKGROUND

The requirements on rafts have been basically unchanged since their introduction in FAR 25 in 1965. The rafts available at that time weighed up to 150 pounds and were stored in closets or overhead compartments. As such these rafts were portable, and the current regulation are not adapted to a case where most of the rafts would be non portable.

The A380 design is such that most rafts are not portable. The JAA considers that there is a need to define a special condition, in order to prescribe conditions applicable to no-portable rafts, because “the product has novel or unusual design features relative to design practices on which the applicable JAR is based”(JAR 21.16 (a)(1)).

The issue of rafts portability has been discussed by the Aviation Rulemaking Advisory Committee (ARAC) and has resulted in draft NPRM ref. RIN 2120-AF79 dated 10/4/99.

In line with the draft NPRM mentioned above, the JAA proposed to amend JAR 25.1411 by revising paragraphs (d), (d)(1), (d)(2), (d)(4) and 25.1415 by revising (b), (b)(1) to read as follows:

SPECIAL CONDITION

JAR 25.1411 General (revised)

(d) Rafts

- (1) The stowage provisions for the rafts described in JAR 25.1415 must accommodate enough rafts for the maximum number of occupants for which certification for ditching is requested.
- (2) Portable rafts must be stowed near exits at which the rafts can be launched during an unplanned ditching. Non-portable raft must be stowed in a manner that will allow use at the associated exit during an unplanned ditching.
- (3) [unchanged].
- (4) The stowage provisions for each portable raft must allow rapid detachment and removal of the raft for use at other than the intended exits.

JAR 25.1415 Ditching equipment (revised)

(b) Each raft and each life preserver must be approved. In addition:

- (1) Rafts of sufficient buoyancy and seating capacity must be provided such that :
 - (i) the rate capacity of the rafts accommodates all aeroplane occupants.
 - (ii) the overload capacity of the remaining rafts accommodates all aeroplane occupants in the event of the loss of :
 - A-the portable raft with the largest overload capacity, and
 - B-50% of the non-portable rafts

Note: Each paragraph of this requirement must be considered for each deck independently.

– END –

EQUIVALENT SAFETY FINDING	F-11 ESF: Pneumatic Systems
APPLICABILITY:	A380
REQUIREMENTS:	JAR 25X1436, 25.1438
ADVISORY MATERIAL:	ACJ 25.1436, 25.1438

BACKGROUND

Airbus indicated that they do not want to apply 25X1436 to certify pressure gas systems but would prefer to use the ARAC proposed harmonised 25.1438.

A report has been provided to the ARAC committee, which proposes a new Pneumatic and Pressurisation rule harmonised.

The intent of the proposed rule is to combine the requirements of section 25.1438 of the Federal Aviation Regulations (FAR), paragraph 25X1436 and 25.1438 Joint Aviation Requirements (JAR), and the advisory material for paragraphs 25X1436 and 25.1438 of the JAR into one rule.

In addition, the proposed rule associated with the ARAC proposed harmonised 25.1435 (as introduced per CRI F-15) enables to delete Appendix K of JAR 25.

The rule format is similar to the advisory material for JAR 25.1438; however, the design standards have been placed in the text of the rule instead of the advisory material. The multipliers in the advisory material for paragraphs 25X1436 and 25.1438 of the JAR are changed based on aeroplane manufacturer design practices and service history of aeroplane bleed air systems.

JAR 25X1436 has been applied to gas storage devices such as hydraulic system accumulators and nitrogen bottles used in back up thrust reverser, flight control, and nitrogen bottles used in door opening and evacuation systems. The FAA applies Department of Transportation (DOT) regulations to gas storage devices such as nitrogen and oxygen bottles. The MSHWG found it acceptable to include requirements for gas storage devices in the rule; however, the group agreed to accept that each country can apply national standards in addition to the proposed minimum requirement for gas storage devices.

As a result the intent of 25X1436 is captured within the harmonised rule for 25.1438 and therefore eliminates the need for a separate rule.

The proposed rule maintains the same level of safety without affecting the current industry practice. The new requirements are as severe as the current ones and clearer.

EQUIVALENT SAFETY FINDING

Delete JAR 25X1436

Replace JAR 25.1438 by the following JAR 25.1438

Delete ACJ 25X1436(b)(3)

Delete ACJ 25X1436(c)(2)

Delete ACJ 25.1438

Delete Appendix K of JAR 25

JAR 25.1438 Pneumatic Systems

- (a) This requirement applies to pneumatic systems and elements (components and ducting) served by gas storage devices such as, evacuation, water systems, accumulators and/or pressurised gas from compressors such as engine and APU bleed air, air conditioning, pressurisation, engine starting, ice-protection, and pneumatic actuation systems. Design

compliance may be in the form of analysis, test, or combination of analysis and test. All foreseen normal and failure mode combinations of environmental loads (installation, thermal, vibration, and aerodynamic), pressures, temperatures, material properties, and dimensional tolerances must be considered. This requirement is not applicable to portable gas storage devices.

- (b) Each element of the system must be designed to operate without detrimental permanent deformation or increase in design leakage that would prevent the element from performing its intended function.

For demonstrating compliance, the following factors are to be applied to the pressure at the associated temperature for the most critical of the following conditions. The pressure must be applied long enough to ensure complete expansion of the test element. After being subjected to the above conditions and on normal operating conditions being restored, the element should operate as designed.

- 1) 1.5 times maximum normal operating
- 2) 1.33 times the failure pressure occurring in the probability range between 10E-03 to 10E-05 failures per flight hour
- 3) 1.0 times the failure pressure occurring in the probability range between less than 10E-05 failures per flight hour
- 4) 1.0 times the maximum normal operating pressure in combination with the limit structural loads.

- (c) Each element of the system must be designed to operate without rupture or increase in design leakage, that is likely to endanger the aeroplane or its occupants. For demonstrating compliance, the following factors are to be applied to the pressure at the associated temperature for the most critical of the following conditions. The pressure must be applied long enough to ensure complete expansion of the test element. After being subjected to the above conditions and on normal operating conditions being restored, the element need not operate normally.

- 1) 3.0 times maximum normal operating pressure. Except for pressurisation system elements which shall use a factor of 2.0 time maximum normal operating pressure
- 2) 2.66 times the failure pressure occurring in the probability range between 10E-03 to 10E-05 failures per flight hour
- 3) 1.5 times the failure pressure occurring in the probability range between 10E-05 to 10E-07 failures/flight hour is applicable to components. Except for ducting which shall use a factor of 2.0 times the failure pressure occurring in the probability range between 10E-05 to 10E-07 failures per flight hour
- 4) 1.0 times the failure pressure occurring in the probability range less than 10E-07 failures per flight hour
- 5) 1.5 times the maximum normal operating pressure in combination with the 1.0 times the ultimate structural loads.

- (d) If the failure of an element can result in a hazardous condition, it must be designed to withstand the fatigue effects of all cyclic pressures, including transients, and associated externally induced loads and perform as intended for the design life of the element under all environmental conditions for which the aeroplane is certified.

- (e) In addition, each gas storage device installed on an aeroplane must meet the requirement of this rule and not cause hazardous effects by exploding.

The JAA team considered that the new paragraph 25.1438, as proposed by ARAC and quoted above provides an equivalent level of safety to the application of JAR25X1436 and JAR 25.1438 at change 15.

– END –

SPECIAL CONDITION	F-12 SC: HIRF protection
APPLICABILITY:	A380
REQUIREMENTS:	JAR 25
ADVISORY MATERIAL:	N/A

BACKGROUND

The basic concern for better identification and protection from High Intensity Radiated Fields, has arisen for the following reasons:

- Operation of modern aeroplanes is increasingly dependent upon electrical/electronic systems, which can be responsive to electromagnetic interference.
- The increasing use of non-metallic materials like carbon or glass fibre in the construction of the aeroplane, reduces their basic shielding capability against the effects of radiation from external emitters.
- Those emitters are increasing in number and in power. They include ground based systems (communication, television, radio, radars and satellite uplink transmitters), as well emitters on ships or other aircraft.

JAA are presently developing in co-operation with the FAA, a regulatory project for HIRF. This project is co-ordinated by the FAA/JAA Electromagnetic Effects Harmonisation Working Group and relies heavily on work conducted by EUROCAE WG 33, in co-operation with SAE-AE4R.

The objective of the project is the issuance of an NPA (Notice of Proposed Amendment) in parallel with an FAA NPRM leading to a final rule and associated advisory material (Advisory Material Joint, and Users Guide).

The Electromagnetic Effects Harmonisation Working Group adopted a set of HIRF environment levels in November 1998 together with a proposed NPA/NPRM, which were agreed upon by FAA, JAA and industry working group participants. The environment levels recommended by this working group are included in JAA Interim Policy INT/POL 25/2 issue 2.

As JAR 25 has not yet been amended to take into account these environment levels, it is proposed to apply a Special Condition to the A380, in accordance with JAR 21.16(a)(3).

SPECIAL CONDITION

The aeroplane electrical and electronic systems, equipment, and installations considered separately and in relation to other systems must be designed and installed so that:

- a. Each function, the failure of which would prevent the continued safe flight and landing of the aeroplane:
 1. Is not adversely affected when the aeroplane is exposed to the Certification HIRF environment defined in Appendix 1.
 2. Following aeroplane exposure to the Certification HIRF environment, each affected system that performs such a function automatically recovers normal operation unless this conflicts with other operational or functional requirements of that system.
- b. Each system that performs a function, the failure of which would prevent the continued safe flight and landing of the aeroplane, is not adversely affected when the aeroplane is exposed to the normal HIRF environment defined in Appendix 1.
- c. Each system that performs a function, the failure of which would cause large reductions in the capability of the aeroplane or the ability of the crew to cope with adverse operating

conditions, is not adversely affected when the equipment providing these functions is exposed to the equipment HIRF test levels defined in Appendix 1.

- d. Each system that performs a function, the failure of which would reduce the capability of the aeroplane or the ability of the crew to cope with adverse operating conditions, is not adversely affected when the equipment providing these functions is exposed to the equipment HIRF test levels defined in Appendix 1.

APPENDIX 1

a) HIRF environments

Table I lists the Certification HIRF environment required by SC F-12 sub-paragraph (a).

Table II lists the Normal HIRF environment required by SC F-12 sub-paragraph (b).

b) Test levels for complying with SC F-12 sub-paragraph (c)

As a minimum, one of the following sets of equipment test levels shall be used:

1. From 10 kHz to 400 MHz, use conducted susceptibility tests with CW and 1 kHz square wave modulation of depth greater than 90 percent. The conducted susceptibility current shall start at 0.6 mA at 10 kHz, increasing 20 dB per frequency decade to 30 mA at 500 kHz. From 500 kHz to 400 MHz, the conducted susceptibility current shall be 30 mA. From 100 MHz to 400 MHz, use radiated susceptibility tests at 20 V/m peak, with CW and 1 kHz square wave modulation of depth greater than 90 percent. From 400 MHz to 8 GHz, use radiated susceptibility tests at 150 V/m peak with pulse modulation of 0.1 percent duty cycle with 1 kHz pulse repetition frequency. This signal should be switched on and off at a rate of 1 Hz with a duty cycle of 50 percent. Also, from 400 MHz to 8 GHz, use radiated susceptibility tests at 28 V/m peak with 1 kHz square wave modulation of depth greater than 90 percent. This signal should be switched on and off at a rate of 1 Hz (ref. ED-14D/DO-160D, Section 20, Cat. R).
2. Or, from 10 kHz to 400 MHz, use conducted susceptibility tests with CW and 1 kHz square wave modulation of depth greater than 90 percent. The conducted susceptibility current shall start at 0.6 mA at 10 kHz, increasing 20 dB per frequency decade to 30 mA at 500 kHz. From 500 kHz to 400 MHz, the conducted susceptibility current shall be 30 mA. From 100 MHz to 400 MHz, use radiated susceptibility tests at 20 V/m peak, with CW and 1 kHz square wave modulation of depth greater than 90 percent. From 400 MHz to 8 GHz, use radiated susceptibility tests at 150 V/m peak with pulse modulation of 4 percent duty cycle with a 1 kHz pulse repetition frequency. This signal should be switched on and off at a rate of 1 Hz with a duty cycle of 50 percent (ref. ED-14D/DO-160D, Section 20, Cat. R).
3. Or, the test level to be used during equipment testing may be based on the Normal HIRF environment in Table II with allowance made for aircraft attenuation using aircraft transfer function/attenuation curves. Testing must cover the frequency band of 10 kHz to 8 GHz.

c) Test levels for complying with F-12 sub-paragraph (d)

As a minimum, the following equipment test level shall be used:

From 10 kHz to 400 MHz, use conducted susceptibility tests, starting at 0.15 mA at 10 kHz, increasing 20 dB per frequency decade to 7.5 mA at 500 kHz. From 500 kHz to 400 MHz, use conducted susceptibility tests at 7.5 mA. From 100 MHz to 8 GHz, use radiated susceptibility tests at 5 V/m (ref. ED-14D/DO-160D, Section 20, CAT T).

d) Test procedures

AC/AMJ 20.1317 Final Draft Issue (EEHWG Document WG-327 dated November 98) and EUROCAE ED-14D/RTCA Document DO-160D, Section 20 should be referred to for the applicability of tests and test details.

TABLE I
CERTIFICATION HIRF ENVIRONMENT

FREQUENCY	FIELD STRENGTH (V/m)	
	PEAK	AVERAGE
10 kHz - 100 kHz	50	50
100 kHz - 500 kHz	50	50
500 kHz - 2 MHz	50	50
2 MHz - 30 MHz	100	100
30 MHz - 70 MHz	50	50
70 MHz - 100 MHz	50	50
100 MHz - 200 MHz	100	100
200 MHz - 400 MHz	100	100
400 MHz - 700 MHz	700	50
700 MHz - 1 GHz	700	100
1 GHz - 2 GHz	2000	200
2 GHz - 4 GHz	3000	200
4 GHz - 6 GHz	3000	200
6 GHz - 8 GHz	1000	200
8 GHz - 12 GHz	3000	300
12 GHz - 18 GHz	2000	200
18 GHz - 40 GHz	600	200

TABLE II
NORMAL HIRF ENVIRONMENT

FREQUENCY	FIELD STRENGTH (V/m)	
	PEAK	AVERAGE
10 kHz - 100 kHz	20	20
100 kHz - 500 kHz	20	20
500 kHz - 2 MHz	30	30
2 MHz - 30 MHz	100	100
30 MHz - 70 MHz	10	10
70 MHz - 100 MHz	10	10
100 MHz - 200 MHz	30	10
200 MHz - 400 MHz	10	10
400 MHz - 700 MHz	700	40
700 MHz - 1 GHz	700	40
1 GHz - 2 GHz	1300	160
2 GHz - 4 GHz	3000	120
4 GHz - 6 GHz	3000	160
6 GHz - 8 GHz	400	170
8 GHz - 12 GHz	1230	230
12 GHz - 18 GHz	730	190
18 GHz - 40 GHz	600	150

– END –

EQUIVALENT SAFETY FINDING and IM	F-15 ESF & IM: Hydraulic Systems
APPLICABILITY:	A380
REQUIREMENTS:	JAR 25.1435
ADVISORY MATERIAL:	N/A

BACKGROUND

Airbus has elected to comply with NPA 25F273 “Hydraulic systems” dated 05/08/1996.

NPA 25F273, after publication in August 1996, went through comment within JAA and FAA (NPRM 96-6 and notice of availability of AC 25.1435-1). These comments have been addressed by the Hydraulics Harmonisation Working Group within a final comment/response document dated October 1998, including a revised proposal for JAR 25.1435 and AMJ 25.1435.

The elect to comply with NPA 25F273 in its final proposal dated October 1998 was accepted by JAA.

EQUIVALENT SAFETY FINDING

Modify JAR 25.1435 to read as follows :

25.1435 Hydraulic Systems (See AMJ 25.1435)

(a) Element design

Each element of the hydraulic system must be designed to:

(1) Withstand the proof pressure without permanent deformation that would prevent it from performing its intended function, and the ultimate pressure without rupture. The proof and ultimate pressures are defined in terms of the design operating pressure (DOP) as follows:

	Element	Proof (x DOP)	Ultimate (x DOP)
1.	Tubes and fittings	1.5	3.0
2.	Pressure vessels containing gas		
	High pressure (e.g. accumulators)	3.0	4.0
	Low pressure (e.g. reservoirs)	1.5	3.0
3.	Hoses	2.0	4.0
4.	All other elements	1.5	2.0

(2) Withstand, without deformation that would prevent it from performing its intended function, the design operating pressure in combination with limit structural loads that may be imposed;

(3) Withstand, without rupture, the design operating pressure multiplied by a factor of 1.5 in combination with ultimate structural loads that can reasonably occur simultaneously;

(4) Withstand the fatigue effects of all cyclic pressures, including transients, and associated externally induced loads, taking into account the consequences of element failure; and

(5) Perform as intended under all environmental conditions for which the aeroplane is certificated.

(b) System design

Each hydraulic system must:

(1) Have means located at a flight crew member station to indicate appropriate system parameters if,

(i) It performs a function necessary for continued safe flight and landing; or

(ii) In the event of hydraulic system malfunction, corrective action by the crew to ensure continued safe flight and landing is necessary;

(2) Have means to ensure that system pressures, including transient pressures and pressures from fluid volumetric changes in elements that are likely to remain closed long enough for such changes to occur, are within the design capabilities of each element, such that they meet the requirements defined in JAR 25.1435(a)(1) to JAR 25.1435(a)(5) inclusive;

(3) Have means to minimise the release of harmful or hazardous concentrations of hydraulic fluid or vapours into the crew and passenger compartments during flight;

(4) Meet the applicable requirements of JAR 25.863, 25.1183, 25.1185 and 25.1189 if a flammable hydraulic fluid is used; and

(5) Be designed to use any suitable hydraulic fluid specified by the aeroplane manufacturer, which must be identified by appropriate markings as required by JAR 25.1541.

(c) Tests

Tests must be conducted on the hydraulic system(s), and/or subsystem(s) and element(s), except that analysis may be used in place of or to supplement testing where the analysis is shown to be reliable and appropriate. All internal and external influences must be taken into account to an extent necessary to evaluate their effects, and to assure reliable system and element functioning and integration. Failure or unacceptable deficiency of an element or system must be corrected and be sufficiently retested, where necessary.

(1) The system(s), subsystem(s), or element(s) must be subjected to performance, fatigue, and endurance tests representative of aeroplane ground and flight operations.

(2) The complete system must be tested to determine proper functional performance and relation to other systems, including simulation of relevant failure conditions, and to support or validate element design.

(3) The complete hydraulic system(s) must be functionally tested on the aeroplane in normal operation over the range of motion of all associated user systems. The test must be conducted at the relief pressure or 1.25 times the DOP if a system pressure relief device is not part of the system design. Clearances between hydraulic system elements and other systems or structural elements must remain adequate and there must be no detrimental effects.

INTERPRETATIVE MATERIAL

Delete ACJ 25.1435(a)(4)

Delete ACJ 25.1435(a)(8)

Delete ACJ 25.1435(b)(2)

Introduce a new AMJ 25.1435:

AMJ 25.1435**HYDRAULIC SYSTEMS - DESIGN, TEST, ANALYSIS AND CERTIFICATION****1. PURPOSE**

This AMJ (Advisory Material Joint) which is similar to the FAA Advisory Circular AC 25.1435-1 provides advice and guidance on the interpretation of the requirements and on the acceptable means, but not the only means, of demonstrating compliance with the requirements of JAR 25.1435. It also identifies other paragraphs of the Joint Aviation Requirements (JAR) that contain related requirements and other related and complementary documents.

The advice and guidance provided does not in any way constitute additional requirements but reflects what is normally expected by the Joint Aviation Authorities (JAA).

2. RELATED REGULATORY MATERIAL AND COMPLEMENTARY DOCUMENTS**(a) Related Joint Aviation Requirements**

JAR-25 Paragraphs (and their associated ACJ/AMJ material where applicable) that prescribe requirements related to the design substantiation and certification of hydraulic systems and elements include:

JAR 25.301	Loads
JAR 25.303	Factor of safety
JAR 25.863	Flammable fluid fire protection
JAR 25.1183	Flammable fluid-carrying components
JAR 25.1185	Flammable fluids
JAR 25.1189	Shutoff means
JAR 25.1301	Function and installation
JAR 25.1309	Equipment, systems and installations
JAR 25.1322	Warning, caution and advisory lights
JAR 25.1541	General: Markings and Placards

Additional JAR-25 paragraphs (and their associated ACJ/AMJ material where applicable) that prescribe requirements which can have a significant impact on the overall design and configuration of hydraulic systems are, but are not limited to:

JAR 25.671	General: Control systems
JAR 25.729	Retracting mechanism
JAR 25.903	Engines
JAR 25X1315	Negative acceleration

(b) Complementary Documents

Documents which are considered to provide appropriate standards for the design substantiation and certification of hydraulic systems and system elements may include, but are not limited to:

(i) **Joint Technical Standard Orders (JTSO's)**

JTSO-C47	Pressure Instruments - Fuel, Oil and Hydraulic
JTSO-2C75	Hydraulic Hose Assemblies

(ii) **Society of Automotive Engineers (SAE) Documents**

ARP 4752	Aerospace - Design and
Installation of Commercial	Transport Aircraft Hydraulic Systems

Note: This document provides a wide range of Civil, Military and Industry document references and standards which may be appropriate.

(iii) **International Organisation for Standardisation (ISO) Documents**

ISO 7137	Environmental Conditions and Test Procedures for Airborne Equipment
----------	---

(iv) **US Military Documents**

MIL-STD-810	Environmental Test Methods and Engineering Guidelines
-------------	---

(v) **Joint Aviation Authorities Publication**

Information Leaflet No. 20 Temporary Guidance Material for Extended Range Operation with Two-Engine Aeroplanes ETOPS Certification and Operation (1.7.97(revised))

(vi) **The European Organisation for Civil Aviation Equipment Documents**

<u>ED-14D/RTCA DO-160D</u>	<u>Environmental Conditions and Test Procedures for Airborne Equipment</u>
----------------------------	--

3. ADVICE AND GUIDANCE

(a) **Element Design**

(1) Ref. JAR 25.1435(a)(1) The design operating pressure (DOP) is the normal maximum steady pressure. Excluded are reasonable tolerances, and transient pressure effects such as may arise from acceptable pump ripple or reactions to system functioning, or demands that may affect fatigue. Fatigue is addressed in sub-paragraph (a)(4) of this paragraph.

The DOP for low pressure elements (e.g., return, case-drain, suction, reservoirs, etc.) is the maximum pressure expected to occur during normal user system operating modes. Included are transient pressures that may occur during separate or simultaneous operation of user systems such as slats, flaps, landing gears, thrust reversers, flight controls, power transfer units, etc. Short term transient pressures, commonly referred to as pressure spikes, that may occur during the selection and operation of user systems (e.g., those pressure transients due to the opening and closing of selector/control valves, etc.) may be excluded, provided the fatigue effect of such transients is addressed in accordance with sub-paragraph (a)(4) of this paragraph.

In local areas of systems and elements the DOP may be different from the above due to the range of normally anticipated aeroplane operational, dynamic and environmental conditions. Such differences should be taken into account.

At proof pressure, seal leakage not exceeding the allowed maximum in-service leak rate is permitted. Each element should be able to perform its intended functions when the DOP is restored.

For sub-paragraphs (a)(1), (a)(2) and (a)(3) of this paragraph, the pressure and structural loads, as applicable, should be sustained for sufficient time to enable adequate determination that compliance is demonstrated. Typically a time of 2 minutes for proof conditions and 1 minute for ultimate conditions will be considered acceptable.

The term "pressure vessels" is not intended to include small volume elements such as lines, fittings, gauges, etc. It may be necessary to use special factors for elements fabricated from non-metallic/composite materials.

(2) Ref. JAR 25.1435(a)(2) Limit structural loads are defined in JAR 25.301(a). The loading conditions of JAR 25, subpart C to be considered include, but are not limited to, flight and ground manoeuvres, and gust and turbulence conditions. The loads arising in these conditions should be combined with the maximum hydraulic pressures, including transients, that could occur simultaneously. Where appropriate, thermal effects should also be accounted for in the strength justification. For hydraulic actuators equipped with hydraulic or mechanical locking features, such as flight control actuators and power steering actuators, the actuators and other loaded elements should be designed for the most severe combination of internal and external loads that may occur in use. For hydraulic actuators that are free to move with external loads, i.e. do not have locking features, the structural loads are the same as the loads produced by the hydraulic actuators. At limit load, seal leakage not exceeding the allowed maximum in-service leak rate is permitted.

(3) Ref. JAR 25.1435(a)(3) For compliance, the combined effects of the ultimate structural load(s) as defined in JAR 25.301 and 25.303 and the DOP, which can reasonably occur simultaneously, should be taken into account with a factor of 1.5 applied to the DOP. In this case the overall structural integrity of the element should be maintained. However, it may be permissible for this element to suffer leakage, permanent deformation, operational/functional failure or any combination of these conditions. Where appropriate, thermal effects should also be accounted for in the strength justification.

(4) Ref. JAR 25.1435(a)(4) Fatigue, the repeated load cycles of an element, is a significant contributor to element failure. Hydraulic elements are mainly subjected to pressure loads, but may also see externally induced load cycles (e.g. structural, thermal, etc.). The applicant should define the load cycles for each element. The number of load cycles should be evaluated to

produce equivalent fatigue damage encountered during the life of the aeroplane or to support the assumptions used in demonstrating compliance with JAR 25.1309. For example, if the failure analysis of the system allows that an element failure may occur at 25% of aeroplane life, the element fatigue life should at least support this assumption.

(5) Ref. JAR 25.1435(a)(5) Aeroplane environmental conditions that an element should be designed for are those under which proper function is required. They may include, but are not limited to temperature, humidity, vibration, acceleration forces, icing, ambient pressure, electromagnetic effects, salt spray, cleaning agents, galvanic, sand, dust and fungus. They may be location specific (e.g., in pressurised cabin vs. in unpressurised area) or general (e.g. attitude). For further guidance on environmental testing, suitable references include, but are not limited to, Military Standard, MIL-STD-810 "Environmental Test Methods and Engineering Guidelines", The European Organisation for Civil Aviation Equipment Document ED-14D "Environmental Conditions and Test Procedures for Airborne Equipment" or International Organisation for Standardisation Document No. ISO 7137 "Environmental Conditions and Test Procedures for Airborne Equipment".

(b) System Design

Ref. JAR 25.1435(b) Design features that should be considered for the elimination of undesirable conditions and effects are:

(a) Design and install hydraulic pumps such that loss of fluid to or from the pump cannot lead to events that create a hazard that might prevent continued safe operation. For example, engine driven pump shaft seal failure or leakage in combination with a blocked fluid drain, resulting in engine gear box contamination with hydraulic fluid and subsequent engine failure.

(b) Design the system to avoid hazards arising from the effects of abnormally high temperatures which may occur in the system under fault conditions.

(1) Ref. JAR 25.1435(b)(1) Appropriate system parameters may include, but are not limited to, pump or system temperatures and pressures, system fluid quantities, and any other parameters which give the pilot indication of the functional level of the hydraulic systems.

(2) Ref. JAR 25.1435(b)(2) Compliance may be shown by designing the systems and elements to sustain the transients without damage or failure, or by providing dampers, pressure relief devices, etc.

(3) Ref. JAR 25.1435(b)(3) Harmful or hazardous fluid or vapour concentrations are those that can cause short term incapacitation of the flight crew or long term health effects to the passengers or crew. Compliance may be shown by taking design precautions, to minimise the likelihood of releases and, in the event of a release, to minimise the concentrations. Suitable precautions, based on good engineering judgement, include separation of air conditioning and hydraulic systems, shut-off capability to hydraulic lines, reducing the number of joints and elements, shrouding, etc. In case of leakage, sufficient drainage should be provided.

(4) Ref. JAR 25.1435(b)(4) Unless it has been demonstrated that there are no circumstances which can exist (on the aeroplane) under which the hydraulic fluid can be ignited in any of its physical forms (liquid, atomised, etc.), the hydraulic fluid should be considered to be flammable.

(5) Ref. JAR 25.1435(b)(5) If more than one approved fluid is specified, the term “suitable hydraulic fluid” is intended to include acceptable mixtures. Typical nameplate marking locations for hydraulic fluid use are all hydraulic components having elastomer seals such as cylinders, valves, reservoirs, etc.

(c) Tests

Ref. JAR 25.1435(c) Test conditions should be representative of the environment that the element, subsystem or system may be exposed to in the design flight envelope. This may include loads, temperature, altitude effects, humidity, and other influences (electrical, pneumatic, etc.). Testing may be conducted in simulators, or standalone rigs, integrated laboratory rigs, or on the aeroplane. The test plan should describe the objectives and test methods. All interfaces between the aeroplane elements and the test facilities should be adequately represented.

(1) Ref. JAR 25.1435(c)(1) Testing for performance should demonstrate rates and responses required for proper system operation. Testing for fatigue (the repeated load cycling of an element) and endurance (the ability of parts moving relative to each other to continue to perform their intended function) should be sufficient to show that the assumptions used in demonstrating compliance with JAR 25.1309 are correct, but are not necessary to demonstrate aeroplane design life. As part of demonstrating that the element(s), sub-system(s), or system(s) perform their intended functions, the manufacturer (applicant) may select procedures and factors of safety identified in accepted manufacturing, national, military, or industry standards, provided that it can be established that they are suitable for the intended application. Minimum design factors specified in those standards or the requirements may be used unless more conservative factors have been agreed with the Authority.

An acceptable test approach for fatigue or endurance testing is to:

- (a) Define the intended element life;
- (b) Determine the anticipated element duty cycle;
- (c) Conduct testing using the anticipated or an equivalent duty cycle.

(2) Ref. JAR 25.1435(c)(2) The tests should include simulation of hydraulic system failure conditions in order to investigate the effect(s) of those failures, and to correlate with the failure conditions considered for demonstrating compliance with JAR 25.1309. Relevant failure conditions to be tested are those which cannot be shown to be extremely improbable and have effects assessed to be major, hazardous, or have significant system interaction or operational implications.

(3) Ref. JAR 25.1435(c)(3) Compliance with JAR 25.1435(c)(3) can be accomplished by applying a test pressure to the system using aeroplane pumps or an alternate pressure source (e.g. ground cart). The test pressure to be used should be just below the pressure required to initiate system pressure relief (cracking pressure). Return and suction pressures are allowed to be those which result from application of the test pressure to the pressure side of the system.

Some parts of the system(s) may need to be separately pressurised to ensure the system is completely tested. Similarly, it may be permissible that certain parts of the system need not be

tested if it can be shown that they do not constitute a significant part of the system with respect to the evaluation of adequate clearances or detrimental effects.

– END –

EQUIVALENT SAFETY FINDING	F-23 ESF: Landing light switch
APPLICABILITY:	A380
REQUIREMENTS:	JAR 25.1383(b)
ADVISORY MATERIAL:	N/A

BACKGROUND

JAR 25.1383(b) requires separate switches for each landing light but allows that one switch is used for the lights of a multiple light installation at one location.

For the Airbus A380, the four fixed position landing lights are integrated two by two in each wing leading edge. Airbus plans to have a single cockpit switch which will activate the landing lights.

An equivalent level of safety is necessary.

EQUIVALENT SAFETY FINDING

On A380, as on any A320/A330/A340, the overhead panel landing lights switches are “command” switches that provide a command signal to the actual power switching device.

On the A380 the status information of the landing light switch is provided by two independent sources.

In case of discrepancy between those two signals the default value is ON.

The FMEA/FMES data provided by lighting dependent systems and exterior lighting supplier will give the adequate answer to the probability requirements which derive from the FHA.

In terms of human factors and cockpit design the single switch has the following advantages: it is more logical to associate a single switch with a single function than two switches with a single function; it results in a less-cluttered overhead panel which makes switch identification easier and thus reduces workload and errors; it reduces the risk of mis-selection (selecting only one switch when the intention was to select both).

In terms of safety, night landings without landing lights are common, particularly in misty conditions where the glare from the lights is distracting, and should be well within the capabilities of all qualified commercial pilots. Thus a complete failure of the landing lights would have only minor repercussions.

The combination of all these factors shows an equivalent level of safety for the above mentioned requirement.

EASA accepted above Airbus demonstration on the basis of the arguments presented and the understanding that no single failure apart from the mechanical part of the switch can prevent the activation of the landing lights. This is to be verified through the FHA/PSSA. Inability to switch off the lights in case of intempestive activation is also to be considered in the FHA.

– END –

SPECIAL CONDITION and IM	F-26 SC & IM: Flight Recorders, Data Link recording
APPLICABILITY:	A380
REQUIREMENTS:	JAR 25.1301, 1457, 1459
ADVISORY MATERIAL:	EUROCAE ED55, ED56A, ED112

BACKGROUND

The Airbus A380 aircraft is required to have a cockpit voice recorder (CVR) and a flight data recorder (FDR) to meet operational requirements for the purposes of accident investigation.

ICAO Annex 6 (Amendment 26) specifies that all aeroplanes for which the individual certificate of airworthiness is first issued after 1 January 2005, which utilise data-link communications and are required to carry a cockpit voice recorder, shall record on a flight recorder, all data link communications to and from the aeroplane.

For the CVR, JTSO C123a, based on EUROCAE document ED 56A, dated October 1993, provides a CVR standard that meets the current requirements of the accident investigation authorities. EUROCAE ED 56A will be superseded by the new standard EUROCAE ED 112 addressing both voice and data link applications.

For the FDR, the parameters to be recorded vary depending on the rules applied by each regulatory authority. JTSO C124a, based on EUROCAE document ED 55, dated April 1990, and provides FDR standards which are considered to be acceptable by the regulatory authorities. A parameter definition based on ED 55 meets the current objectives of the accident investigation authorities. However ICAO Annex 6 chapter 6.3.1.8 defines a more extensive list of parameters (Type Ia FDR) that should be recorded for aeroplanes with a maximum certificated take-off mass over 27 000 kg and for which the individual certificate of airworthiness is first issued after 1 January 2005. As the A380 aircraft target certification date is January 2006, this new ICAO Annex 6 requirement will be applicable at the time of first A380 deliveries.

The A380 will use data-link messages in addition to, or in place of voice messages. Current JAR 25 recording requirements (25.1457 and 25.1459) are not adequate to deal with this new technology.

The intent of JAR 25.1457 was to allow accident investigators to have, as far as practicable, a recording of all communication received or sent by each crew member. With the introduction of data link technology, much of the information which was previously transmitted by voice communications will be replaced by data link messages.

Therefore, in accordance with JAR 21.16(a)(1), the following Special Condition and associated Interpretative Material, based on published EUROCAE document ED 112 "Minimum Operational Performance Specification for crash protected airborne recorder system", are proposed to prescribe recording requirements associated with the introduction of data link.

SPECIAL CONDITION

"The flight recorder (Cockpit Voice Recorder or Flight Data Recorder) shall record:

- (a) Data link communications related to air traffic services (ATSC Communications*) to and from the aeroplane.
- (b) All messages whereby the flight path of the aircraft is authorised, directed or controlled, and which are relayed over a digital data-link rather than by voice communication.

The minimum recording duration shall be equal to the duration of the Cockpit Voice Recorder, and the recorded data shall be time correlated to the recorded cockpit audio.

To enable an aircraft operator to meet the intent of JAR OPS 1.160 (4)(ii), information shall be provided explaining how the recorded data can be converted back to the format of the original data link messages together with associated timing and crew actions.”

* ATS communications (ATSC) are defined by ICAO as communications related to air traffic services including air traffic control, aeronautical and meteorological information, position reporting and services related to safety and regularity of flight.

INTERPRETATIVE MATERIAL

I- Data link recording.

Data link communications mentioned in SC F-26 include controller-pilot data link communications (CPDLC), data link flight information services (D-FIS) and the specific ARINC 623 applications of DCL, OCL and D-ATIS. Data-link communication in this context is limited to communications between the aircraft and the air traffic services via the air traffic network (ATN or over ACARS protocol).

It also will include automatic dependent surveillance (ADS) information, when defined and implemented, to be used for air traffic surveillance purposes unless the corresponding source data is recorded on the FDR. However regarding ADS-C, aircraft position reports should be recorded unless parametric data from the same source is recorded on the FDR. It will allow reconstruction of the aircraft/controller scenario.

In the context of this CRI, air traffic network means any network commissioned by an air traffic service provider.

In showing compliance with the above Special Condition, the data link recording process should be compliant with EUROCAE ED 112 Part IV “Minimum Operational Performance Specification for crash protected airborne recorder system”. The table A-1 in Attachment 1 is derived from the ED-112 table IV-B-1 and shows an acceptable list of data link message types to be recorded.

II- CVR and FDR certification.

In addition, the following defines an acceptable means of compliance for certification of the Cockpit Voice Recorder and Flight Data Recorder Systems:

- Cockpit Voice Recorder System:

JAA JTSO C 123a, which refers to EUROCAE document ED-56A, defines a suitable equipment qualification standard for the CVR.

In showing compliance with JAR 25.1301 and 25.1457 for the cockpit voice recorder equipment and system, audio information additional to the data link messages should be recorded in accordance with ED 56A.

- Flight Data Recorder System:

JAA JTSO C124a, which refers to EUROCAE document ED-55, defines a suitable equipment qualification standard for the FDR.

In showing compliance with JAR 25.1301 and 25.1459, the parameters defined in EUROCAE document ED-55 Table A 1.1 will need to be recorded.

The parameters defined in table A1.5 in respect of the following systems, which are considered to require special consideration, should be recorded also:

- electronic display system;
- status of critical computer systems;
- additional engine parameters;
- centre of gravity trim.

The remaining parameters of Table A 1.5 should be recorded where capacity permits, with priority given to navigation, brake pedal position, autobrake status, secondary engine parameters, engine vibration, ACAS warnings and radio frequencies.

JAR 25.1459(e) requires that any novel or unique design or operational characteristics of the airplane be evaluated to determine the need for any additional parameters to be recorded. Airbus should propose a list of parameters to be recorded in order to demonstrate compliance with this regulation, to be agreed by the JAA team.

To achieve compliance with ICAO Annex 6, Section 6.3.1.8 at time of individual aircraft delivery, recorded parameters will need to comply with the list published in that Section (i.e. Type Ia FDR).

In showing compliance with JAR 25.1301 and 25.1459 for the flight recorder equipment and system, flight data recorder should be qualified in accordance with EUROCAE document ED-55, chapters 4, 5, 6 and 7 and the associated advisory material in the annexes to the document.

In order to be able to meet SC F-26 recording requirements for ADS data link message, when this system is defined and implemented, Airbus is advised to make provision for the recording of ADS digital communications.

– END –

EQUIVALENT SAFETY FINDING	F-29 ESF: New harmonised JAR 25.1329
APPLICABILITY:	A380
REQUIREMENTS:	JAR 25.1329, 25.1335
ADVISORY MATERIAL:	ACJ 25.1329

BACKGROUND

ARAC provided a report in January 2002 on a new proposal for requirements for Flight Guidance Systems and associated advisory material, prompted by efforts to harmonise the requirements, recommendations from the NTSB as a result of accident investigations, and the need to update the rule to address new technological advances. The new proposed rule addressed the integration of new functionality and technology that is provided in current aeroplanes and much that is anticipated for future aeroplanes installations.

The rule intends to increase the level of safety compared to the existing rule.

The A380, like most large modern transport aeroplanes, is equipped with an integrated Flight Guidance System (autopilot, auto-thrust, flight director). On previous Airbus types (A320 and A330/A340), special conditions have been developed to address concerns or features which are not adequately covered by existing requirements.

This includes:

- Auto-thrust system
- Autopilot disconnect : quick release control
- Autopilot synchronisation
- Autopilot minimum use height
- Autopilot disconnect warning

Airbus has proposed to apply this new harmonised rule and material as an Equivalent Safety Finding in accordance with JAR 21.21(c)(2).

EQUIVALENT SAFETY FINDING

Replace JAR 25.1329 and JAR 25.1335 by the following:

JAR 25.1329 Flight Guidance System **[See AC/ACJ 25.1329]**

- (a) Quick disengagement controls for the autopilot and auto-thrust functions must be provided for each pilot. The autopilot quick disengagement controls must be located on both control wheels (or equivalent). The auto-thrust quick disengagement controls must be located on the thrust control levers.
Quick disengagement controls must be readily accessible to each pilot while operating the control wheel (or equivalent) and thrust control levers.
- (b) The effects of a failure of the system to disengage the autopilot or autothrust functions when manually commanded by the pilot must be assessed in accordance with the requirements of §/JAR 25.1309.
- (c) Engagement or switching of the flight guidance system, a mode, or a sensor must not produce a significant transient response affecting the control or flight path of the aeroplane.

- (d) Under normal conditions, the disengagement of any automatic control functions of a flight guidance system must not produce any significant transient response affecting the control or flight path of the aeroplane, nor require a significant force to be applied by the pilot to maintain the desired flight path.
- (e) Under other than normal conditions, transients affecting the control or flight path of the aeroplane resulting from the disengagement of any automatic control functions of a flight guidance system must not require exceptional piloting skill or strength to remain within, or recover to, the normal flight envelope.
- (f) Command reference controls (e.g., heading select, vertical speed) must operate consistently with the criteria specified in §/JAR 25.777(b) and 25.779(a) for cockpit controls. The function and direction of motion of each control must be plainly indicated on, or adjacent to, each control if necessary to prevent inappropriate use or confusion.
- (g) Under any condition of flight appropriate to its use, the Flight Guidance System must not:
 - produce unacceptable loads on the aeroplane (in accordance with §/JAR 25.302), or
 - create hazardous deviations in the flight path.

This applies to both fault-free operation and in the event of a malfunction, and assumes that the pilot begins corrective action within a reasonable period of time.

- (h) When the flight guidance system is in use, a means must be provided to avoid excursions beyond an acceptable margin from the speed range of the normal flight envelope. If the aircraft experiences an excursion outside this range, the flight guidance system must not provide guidance or control to an unsafe speed.
- (i) The FGS functions, controls, indications, and alerts must be designed to minimise flight crew errors and confusion concerning the behaviour and operation of the FGS. Means must be provided to indicate the current mode of operation, including any armed modes, transitions, and reversions. Selector switch position is not an acceptable means of indication. The controls and indications must be grouped and presented in a logical and consistent manner. The indications must be visible to each pilot under all expected lighting conditions.
- (j) Following disengagement of the autopilot, a visual and aural warning must be provided to each pilot and be timely and distinct from all other cockpit warnings.
- (k) Following disengagement of the auto-thrust function, a caution must be provided to each pilot.
- (l) The autopilot must not create an unsafe condition when the flight crew applies an override force to the flight controls.

During auto-thrust operation, it must be possible for the flight crew to move the thrust levers without requiring excessive force. The auto-thrust response to flight crew override must not create an unsafe condition.

– END –

EQUIVALENT SAFETY FINDING	F-38 ESF: Overpressure Relief valves and Outflow valves
APPLICABILITY:	A380
REQUIREMENTS:	JAR 25.841(b)(1), 25.843(b)(1)
ADVISORY MATERIAL:	N/A

BACKGROUND

JAR 25.841(b)(1) requires at least two pressure relief valves to automatically limit the positive pressure to a predetermined value. For the model Airbus A380, Airbus is planning to integrate those overpressure relief valves in the normal regulator valves, i.e. outflow valves. Historically, over pressure valves are independent mechanical devices but for A380, the over pressure relief function is proposed to be covered by software and outflow valves.

An equivalent safety finding is necessary for this new design.

EQUIVALENT SAFETY FINDING

JAR 25.843(b)(1) requires that the following tests must be performed : "Tests of the functioning and capacity of the positive and negative pressure differential valves, and of the emergency release valve, to simulate the effects of closed regulator valves". Since the A380 does not incorporate regulator valves which are distinct from emergency release valves, it is impossible to perform the test with closed regulator valves. It is therefore impossible to comply literally with JAR 25.843(b)(1). Therefore, Airbus must propose appropriate tests to cover the intent of JAR 25.843(b)(1).

JAR 25.365(d) specifies that structural pressure loads to be considered, in relation to the maximum pressure release valve setting. Due to the particularities of the A380 design, the "maximum pressure release valve setting" should be understood as the maximum pressure allowed by the overpressure relief function imbedded in the software logic governing the regulating outflow valves.

Additionally, due to increased level of Cabin Pressure Control System CPCS integration and the associated increased complexity, there is a potential for common cause failures and for development errors. The Common Mode Analysis (CMA) must show that the risk of common cause failures and of development errors has been adequately mitigated, and that the proposed design is equivalently safe or safer, with respect of such risks, to a conventional design.

A380 CPCS architecture is based on four CPIOMs from the IMA

Each of them is connected via ARINC 429 bus to an Outflow Valve Control Sensor Module (OCSM).

Each OSCM controls one skin mounted Outflow Valves (OFV) through direct motor and position feedback links.

The four OCSMs are fully identical with same hardware and same software and therefore could be prone to the risk of common cause failures leading to a Catastrophic Failure condition.

The Emergency Pressurization System (EPS) comprises a part of each OCSM, the OFVs, NRVs and own cabin and ambient pressure sources.

The traditional over pressure safety valves shall be taken into account for certification to address potential common mode failures of the CPCS.

However, based on design, SSA and CMA, and considering the traditional over pressure valves are kept for TC, it is also EASA position that the robustness of CPC system has been sufficiently demonstrated to permit Airbus to take advantage of the provision of SC C-11"Interaction of

Systems and Structures" through CRI C-17 "Fuselage Pressure Loads". Airbus has stated that the SSA of the cabin pressure control system will demonstrate that an uncontrollable over pressure above the EPS value will be extremely improbable without taking the traditional over pressure valves into account. This is sufficient to validate the use of the EPS value as the maximum differential pressure for compliance with 25.365(a) in line with CRI C-17.

EASA agreed that Airbus demonstrated an equivalent level of safety for A380 design.

– END –

EQUIVALENT SAFETY FINDING	F-48 ESF: Use of Computer Simulation and similarity approach for high energy rotor containment demonstration
APPLICABILITY:	A380
REQUIREMENTS:	JAR 25.631, 25.1461(c)
ADVISORY MATERIAL:	N/A

BACKGROUND

JAR 25.1461(c) requires a demonstration by test that equipment containing high energy rotors can contain any failure of the high energy rotor. In addition, SAE ARP 85E advises that high energy rotors shall contain all fragments of the tri-hub burst rotor at 125% of maximum normal speed or maximum failure speed whichever is greater. Fragments are allowed to protrude through the housing but must be contained.

EQUIVALENT SAFETY FINDING

Airbus initially requested an ESF to JAR 25.1461(c) “Equipment containing high energy rotors” and proposed to replace Air Cycle Machine containment tests by a combination of DYTRAN simulation and the complement PE/KE similarity method. Airbus also proposed to use a numerical simulation tool to demonstrate the conformity to JAR 25.631 “Bird strike damage” for the AGU air cycle machines.

However, for JAR 25.1461(c), Airbus finally decided to perform a comprehensive set of containment tests, without taking credit of the simulation tool or the similarity method.

For JAR 25.631, Airbus decided to use the numerical simulation tool and presented validation data related to the use of the code for the proposed conditions to justify that use of numerical simulation can provide reliable and accurate data.

– END –

SPECIAL CONDITION	F-52 SC: Lithium-Ion Batteries Installations
APPLICABILITY:	A380
REQUIREMENTS:	JAR 25.601, 863, 1353(c)
ADVISORY MATERIAL:	N/A

BACKGROUND

Airbus will use a new type of batteries (Lithium-Ion (Li-Ion)) for their emergency lighting system on the A380. They are contained in the emergency power supply units (EPSUs) that ensure power supply to the emergency lighting in case of loss of normal electrical power. The auxiliary standby power supply unit (ASPSU) also hosts such rechargeable Li-Ion batteries to operate the doors associated residual pressure lights under the same conditions.

This type of battery has certain failure and operational characteristics, and maintenance requirements that differ significantly from that of the nickel cadmium (Ni-Cd) and lead acid rechargeable batteries currently approved for installation on large aeroplanes. A Special Condition is being proposed to require that all characteristics of the Li-ion battery and its installation that could affect safe operation of the A380 are addressed and that appropriate maintenance requirements are established to ensure the availability of electrical power from the batteries when needed.

SPECIAL CONDITION

The following Special Condition is applicable to the Li-ion batteries and battery installations of the A380 in lieu of the requirements of JAR 25.1353(c)(1) through (c)(4):

Lithium-ion batteries and battery installations of the A380 must be designed and installed as follows:

- (1) Safe cell temperatures and pressures must be maintained during any probable charging or discharging condition, or during any failure of the charging or battery monitoring system not shown to be extremely remote. The Li-ion battery installation must be designed to preclude explosion in the event of those failures
- (2) Li-ion batteries must be designed to preclude the occurrence of self-sustaining, uncontrolled increases in temperature or pressure.
- (3) No explosive or toxic gasses emitted by any Li-ion battery in normal operation or as the result of any failure of the battery charging or monitoring system, or battery installation not shown to be extremely remote, may accumulate in hazardous quantities within the aeroplane.
- (4) Li-ion battery installations must meet the requirements of JAR 25.863(a) through (d).
- (5) No corrosive fluids or gasses that may escape from any Li-ion battery may damage surrounding structure or any adjacent systems, equipment or electrical wiring, of the airplane in such a way as to cause a major or more severe failure condition in accordance with JAR 25.1309 (b).
- (6) Each Li-ion battery installation must have provisions to prevent any hazardous effect on structure or essential systems that may be caused by the maximum amount of heat the battery can generate during a short circuit of the battery or of its individual cells

- (7) Li-ion battery installations must have a system to control the charging rate of the battery automatically so as to prevent battery overheating or overcharging, and,
- (i) A battery temperature sensing and over-temperature warning system with a means for automatically disconnecting the battery from its charging source in the event of an over-temperature condition or,
 - (ii) A battery failure sensing and warning system with a means for automatically disconnecting the battery from its charging source in the event of battery failure.
- (8) Any Li-ion battery installation whose function is required for safe operation of the aeroplane, must incorporate a monitoring and warning feature that will provide an indication to the appropriate flight crewmembers, whenever the state of charge (SOC) of the batteries have fallen below levels considered acceptable for dispatch of the aeroplane.
- (9) The Instructions for Continued Airworthiness required by JAR 25.1529 must contain maintenance requirements for measurements of battery capacity at appropriate intervals to ensure that batteries whose function is required for safe operation of the aeroplane will perform their intended function as long as the batteries are installed in the aeroplane. The Instructions for Continued Airworthiness must also contain maintenance procedures for Li-ion batteries in spares storage to prevent the replacement of batteries whose function is required for safe operation of the aeroplane, with batteries that have experienced degraded charge retention ability or other damage due to prolonged storage at low SOC.

– END –

EQUIVALENT SAFETY FINDING	F-53 ESF: Supplemental cooling system - Impeller pump containment
APPLICABILITY:	A380
REQUIREMENTS:	JAR 25.1461(c),
ADVISORY MATERIAL:	SAE-ARP 85 Issue E

BACKGROUND

Airbus requests an Equivalent Safety Finding for JAR 25.1461(c) in the frame of the compliance demonstration of the Major Modification 60904 - Supplemental cooling system.

The A380 will optionally be equipped with a supplemental cooling system, which uses an impeller pump to move the cooling fluid "GALDEN", rotating at maximum speed of 16,500 rpm (speed with primary protection devices inoperative: 20,428rpm) and having a diameter of about 55 mm and mass of 0.06 Kg.

JAR 25 1461(c) requires a demonstration by test that equipment containing high-energy rotors can contain any failure of the high-energy rotor. In addition, SAE ARP 85E advises that high energy rotors shall contain all fragments of the tri-hub burst rotor at 135% of maximum normal speed or maximum single failure speed whichever is greater. The calculated SAE containment speed of the pump is 22,275 rpm. Fragments are allowed to protrude through the housing but must be contained.

EQUIVALENT SAFETY FINDING

For the impeller pump, Airbus proposes to replace the containment test by a compliance demonstration based on the combination of geometrical consideration and energy absorption analysis:

- (1) Acceleration of the impeller beyond the protection speed limit will cause the impeller to rub and bind in the pump housing volute, which is substantiated by the results of a Linear Static Stress Analysis for a tri-hub condition under centrifugal loads (using MSC NASTRAN, vendor report N05-QAR7625). It can therefore be concluded that testing according to ARP85 E Section 5 1 3 d, requesting 1.35 times the maximum impeller speed cannot be performed. The impeller will seize and stop at 1.24 times the maximum impeller speed.
- (2) Geometrical comparison of the impeller hub and volute gap shows that radial migration of impeller fragments is not possible. The burst segments will interact with the housing close to the hub of the impeller impeding further progression outwards. Therefore testing according to ARP85 E Section 5 1 3 d is not possible due to geometrical constraints in the design of housing and impeller hub contour.
- (3) The impeller is composed of two brazed parts, a bladed disc and a covering shroud. For the application of the PE/KE method above paragraph (1) is disregarded, such that this analysis can be performed with the idealized assumption that the impeller does not deform during acceleration. Furthermore, in the unlikely event where the brazed part would totally fail, then that part would be able to hit the containment ring. For that case an analysis exists based on PE/KE method, which shows a SF > 3. For this analysis it is conservatively assumed that the pump runs with dry air.

- (4) The impeller size and mass represents a relatively small amount of energy that would be released during the burst event compared to the mass and wall thickness of the containment housing.

EASA agreed that, based on the above rationale, the intent of JAR 25.1461 is met.

– END –

SPECIAL CONDITION	G-06 SC: Ferrying one engine unserviceable
APPLICABILITY:	A380
REQUIREMENTS:	JAR 25X20
ADVISORY MATERIAL:	N/A

BACKGROUND

Airbus applies for operation of ferrying with one engine unserviceable. The authorisation to perform such a ferry flight is an operational responsibility and there will be requirements and guidelines in JAR OPS on this subject.

However, there is a need to define standards and conditions for such a ferry flight. These are usually detailed in an appendix to the AFM approved by the certification authority.

The JAR Flight Study Group has produced draft NPA 25B-239 which details the basis on which the AFM appendix can be approved, with respect to handling qualities and performance requirements.

Draft NPA 25B-239 based on FWP 466 Issue 2 dated 25/02/1993 is proposed as a basis for the approval of the AFM supplement Ferrying one engine unserviceable.

SPECIAL CONDITION

Introduce Supplementary Information as follows;

JAR 25X 20(d) (see Appendix FRR)

Where a manufacturer chooses to furnish supplementary information to permit ferrying a three or four engined aircraft with one engine unserviceable the additional requirements of Appendix FRR must be complied with.

Appendix FRR

Supplementary Information for Ferrying a 3 or 4 engined aircraft with one unserviceable engine

(see JAR 25 X 20(d))

1. APPLICABILITY

The requirements of this Appendix are applicable for the purpose of ferrying a large transport aeroplane with one engine unserviceable. Additional requirements may be prescribed when it is considered that the characteristics of the aeroplane necessitate such requirements.

The level of airworthiness given by this AMJ is lower than that normally assumed by JAR 25 and is suitable for non-revenue, non passenger transport operations to return the aircraft to a place where an engine may be repaired or changed.

The unserviceable engine appropriate to each case below shall be the engine which was critical for the equivalent case during the determination of the normal performance and handling, except that for ferrying minimum control speeds the unserviceable engine shall be that which in association with the failure of a serviceable engine will give the highest minimum control speed. The configuration of the unserviceable engine assumed in establishing the below data shall be scheduled, e.g., propeller feathered, propeller removed, engine locked, etc.

2. DEFINITIONS

2.1 Unserviceable Engine

The engine which is inoperative before flight, and which remains inoperative throughout.

2.2 Serviceable Engine

An engine which is intended to operate throughout the flight.

3. FLIGHT REQUIREMENTS

3.1 Take Off

3.1.1 Take-off Technique

The prescribed take-off data shall be based on a flight technique which permits adequate control at all points in the take-off in the event of cross winds, wet runway and failure of a serviceable engine where it occurs after the decision to become airborne is taken, giving adequate allowance for pilot reaction time.

Note: Where adequate control is not possible on a wet runway, it will be acceptable to introduce a limitation restricting take-off to dry runway conditions only.

3.1.2 Minimum Control Speeds

The Ferrying VMCA and VMCG shall be the speeds arrived at by applying the requirements of JAR 25.149 with the aeroplane initially in the ferrying configuration.

3.1.3 Take-Off Speeds

(a) The ferrying V_2 shall be not less than :

- (i) That defined by JAR 25.107(c); and
- (ii) 1.07 times the ferrying VMCA.

(b) The ferrying V_R shall be not less than :

- (i) That defined by JAR 25.107(e);
- (ii) 1.03 times the ferrying VMCA.
- (iii) The ferrying VMCG; and
- (iv) A speed which enables the ferrying V_2 to be achieved at a height of 35 ft. when taking off with all serviceable engines operating.

(c) The ferrying V_{STOP} shall be the speed to which the aircraft can be accelerated with all serviceable engines operating, and brought to a full stop within the available accelerate - stop distance determined in accordance with the general provisions of JAR 25.109(a)(1), (b), (c), (d), (e), (f), (g).

3.1.4 Take-off Run and Take-Off Distance

The ferrying take-off run and distance shall be 1.15 times the gross distance to 35 ft, the aircraft being accelerated with all serviceable engines operating from the brakes-off point to the Ferrying Rotation Speed, and thereafter climbing to a height of 35 ft. at which point the speed shall not be less than the Ferrying V_2 .

NOTE: The ferrying take-off distance does not include credit for clearway.

3.1.5 Net Take-off Flight Path

The ferrying net take-off flight path which extends from a height of 35 ft. to 1,500 ft., shall be the gross flight path with one serviceable power unit inoperative reduced by gradient of 0.5%.

NOTE:

- (i) where it is not possible to effect a geometry change (e.g., gear or flaps retraction) with one combination of any two engines inoperative, the take-off net flight path shall be determined for the most adverse configuration throughout, and shall be

applicable where either of these two engines is the unserviceable engine at the beginning of the flight.

- (ii) except where stated the conditions of speed and configuration shall be in accordance with JAR 25.111 and JAR 25.115.

3.2 Climb

3.2.1

- (a) Take-off: landing gear retracted.

At a height of 400 feet the steady gradient of climb shall not be less than 1.5% in the following conditions :

- Airspeed - Ferrying V₂.
- Flaps - Ferrying take-off position.
- Power - Critical serviceable engine inoperative, with the propeller feathered, the remaining engines being at MTOP.
- Landing gear - Retracted.

- (b) Final take-off.

At a height of 1,500 ft the en-route gross gradient of climb in the enroute configuration shall be not less than 1.2% in the following conditions:-

- Airspeed - Ferrying en-route climb speed but not less than 1.18 V_{s1g}.
- Flaps - Ferrying en-route position.
- Power - Critical serviceable engine inoperative, with the propeller feathered, the remaining engines being at MCP.
- Landing Gear - Retracted.

Note : Paragraph 3.2.1 (a) and (b). Where it is not possible to retract the landing gear or wing flaps with one combination of any two engines inoperative, compliance shall be shown with the landing gear extended and/or flaps in the ferrying take-off position. Any consequent WAT limitations shall be applicable when either of these two engines is the unserviceable engine.

- (c) Landing

The gross gradient of climb at the altitude of landing shall not be less than 2.0% in the following conditions:

- Airspeed - Ferrying VREF, but not less than 1.23 V_{s1g} or that determined for normal operations in accordance with JAR 25.125(a)(2) and the associated ACJ.
- Flaps - Ferrying landing position.
- Power - all serviceable engines at the power or thrust that is available 8 seconds after initiation of movement of the power or thrust controls from the minimum flight idle to the take-off position.
- Landing Gear - Extended.

3.2.2 Weight/Altitude/Temperature Limitations

- (a) Compliance with paragraphs 3.2.1(a) and (b) must be shown at each weight, altitude and ambient temperature within the operational limits established for take-off.
- (b) Compliance with paragraphs 3.2.1(b) and (c) must be shown at each weight, altitude and ambient temperature within the operational limits established for landing.

Note: The provisions of this paragraph mean that following the decision to land and selection of land flap the ability to carry out a go-around may not be assured in the event of failure of a serviceable engine.

3.2.3 En-route flight paths

- (a) The airspeeds used in establishing all serviceable engines and the one serviceable engine inoperative net data must be not less than those used for final take-off (paragraph 3.2.1 (b)).
- (b) The gross gradient of climb with all serviceable engines operating shall be determined and scheduled.
- (c) The net gradient of climb with the critical serviceable engine inoperative shall be determined and scheduled and shall be the gross gradient diminished by a gradient of 1.0%.

3.3 Landing

3.3.1 Landing distance

The ferrying landing distance shall be that determined under JAR 25.125 (a), except that the speed at 50 ft shall be not less than that determined under Paragraph 3.2.1 (c) above. For an aircraft where a significant contribution to aerodynamic retardation is provided by the engines an additional 5% shall be added to the landing distance.

Note 1: In the determination of the ferrying landing distance it will be acceptable to calculate the increase due to any increase in reference speed.

Note 2: Where a reduction in available retardation from non-aerodynamic sources result when one combination of any two engines are inoperative, then appropriate allowances shall be made.

3.4 Crosswind

The maximum demonstrated ferrying crosswind components for both take-off and landing shall be determined.

4. **FLIGHT MANUAL**

Performance data for ferrying should be determined in accordance with the requirements paragraphs of this document. Procedures and information relating to configuration, piloting techniques, conditions for ferrying and permitted unserviceabilities should be included. AFM procedures should be relevant to the configuration of the inoperative engine and include reference to associated engine or system aspects.

The AFM should include a statement to the effect that the data does not in itself constitute an operational clearance and that such clearance should be sought from the appropriate authority.

5. **REGULATORY STATUS**

Supplementary AFM data should include an explanation of its regulatory status and include reference to applicable Operational Regulations where relevant.

– END –

SPECIAL CONDITION	H-01 SC: Enhanced Airworthiness Programme for Aeroplane Systems – Instructions for Continued Airworthiness (ICA) on Electrical Wiring Interconnection Systems (EWIS)
APPLICABILITY:	A380
REQUIREMENTS:	21A.16B(a)(3), 21A.3B(c)(1), CS 25.1529 & Appendix H
ADVISORY MATERIAL:	N/A

BACKGROUND

Investigations of accidents (for example, midair explosion involving a B747 aeroplane, crash of MD-11 aeroplane) and later examinations of different aeroplane types have identified safety concerns regarding wiring systems in aeroplanes which could potentially result in unsafe conditions.

To enhance the safety of large aeroplanes wiring systems, EASA has developed in cooperation with FAA a regulatory package including new and revised certification and maintenance requirements to address shortcomings of current wiring systems design, installation and maintenance practices. These new certification requirements are contained in CS-25 amendment 5 dated 5 September 2008.

CS-25 amendment 5 is not the applicable Certification Specification of A380. However, in accordance with Part 21A.16B(a)(3), a Special Condition shall be raised if experience from other similar products in service or products having similar design features, has shown that unsafe conditions may develop. Consequently, for A380, the Special Condition H-01 defined in appendix is proposed based on a specific provision of CS-25 amendment 5 Appendix H.

EASA has requested Airbus, as holder of type certificates of A380 aircraft models, to develop appropriate Instructions for Continued Airworthiness (ICA) on the Electrical Wiring Interconnection System (EWIS), derived from the Enhanced Zonal Analysis Procedure (EZAP) in accordance with CS-25 Appendix H paragraph H25.5. These ICA's must be furnished before 10 December 2009 or the date of issuance of the certificate whichever occur later.

SPECIAL CONDITION

Add to: Appendix H Instructions for Continued Airworthiness

H25.5 Electrical Wiring Interconnection Systems Instructions for Continued Airworthiness

The applicant must prepare Instructions for Continued Airworthiness (ICA) applicable to Electrical Wiring Interconnection System (EWIS) as defined below that include the following:

Maintenance and inspection requirements for the EWIS developed with the use of an Enhanced Zonal Analysis Procedure (EZAP) that includes:

- (a) Identification of each zone of the aeroplane.
- (b) Identification of each zone that contains EWIS.
- (c) Identification of each zone containing EWIS that also contains combustible materials.
- (d) Identification of each zone in which EWIS is in close proximity to both primary and back-up hydraulic, mechanical, or electrical flight controls and lines.
- (e) Identification of -
 - Tasks, and the intervals for performing those tasks, that will reduce the likelihood of ignition sources and accumulation of combustible material, and

- Procedures and the intervals for performing those procedures that will effectively clean the EWIS components of combustible material if there is not an effective task to reduce the likelihood of combustible material accumulation.
- (f) Instructions for protections and caution information that will minimize contamination and accidental damage to EWIS, as applicable, during the performance of maintenance, alteration, or repairs.

The ICA must be in the form of a document appropriate for the information to be provided, and they must be easily recognizable as EWIS ICA.

For the purpose of this Appendix H25.5, the following EWIS definition applies:

(a) Electrical wiring interconnection system (EWIS) means any wire, wiring device, or combination of these, including termination devices, installed in any area of the aeroplane for the purpose of transmitting electrical energy, including data and signals between two or more intended termination points. Except as provided for in subparagraph (c) of this paragraph, this includes:

- (1) Wires and cables.
- (2) Bus bars.
- (3) The termination point on electrical devices, including those on relays, interrupters, switches, contactors, terminal blocks, and circuit breakers and other circuit protection devices.
- (4) Connectors, including feed-through connectors.
- (5) Connector accessories.
- (6) Electrical grounding and bonding devices and their associated connections.
- (7) Electrical splices.
- (8) Materials used to provide additional protection for wires, including wire insulation, wire sleeving, and conduits that have electrical termination for the purpose of bonding.
- (9) Shields or braids.
- (10) Clamps and other devices used to route and support the wire bundle.
- (11) Cable tie devices.
- (12) Labels or other means of identification.
- (13) Pressure seals.

(b) The definition in subparagraph (a) of this paragraph covers EWIS components inside shelves, panels, racks, junction boxes, distribution panels, and back-planes of equipment racks, including, but not limited to, circuit board back-planes, wire integration units and external wiring of equipment.

(c) Except for the equipment indicated in subparagraph (b) of this paragraph, EWIS components inside the following equipment, and the external connectors that are part of that equipment, are excluded from the definition in subparagraph (a) of this paragraph:

- (1) Electrical equipment or avionics that is qualified to environmental conditions and testing procedures when those conditions and procedures are -
 - (i) Appropriate for the intended function and operating environment, and
 - (ii) Acceptable to the Agency.
- (2) Portable electrical devices that are not part of the type design of the aeroplane. This includes personal entertainment devices and laptop computers.
- (3) Fibre optics.

– END –

EQUIVALENT SAFETY FINDING and IM	J-02 ESF & IM: APU installation requirements
APPLICABILITY:	A380
REQUIREMENTS:	JAR-25 subpart J section 1, 25.1582, 25.1583(b)(1)
ADVISORY MATERIAL:	JAR-25 subpart J section 2

BACKGROUND

A380 applicable Type Certification Basis is JAR 25 at change 15.

Per letter ref. AI/LE-A 828.0005/99 issue 2 dated April 20, 2001, Airbus has requested to apply NPA 25J-300 – Revised Gas Turbine Auxiliary Power Unit Installations Requirements for Large Aircraft.

NPA 25J-300 has been proposed to revise subpart J "Gas Turbine Auxiliary Power Units Installations" of the Joint Aviation Requirements for Large Aeroplanes (JAR-25) by incorporating changes developed in co-operation with the US Federal Aviation Administration (FAA) and the Aviation Rulemaking Advisory Committee (ARAC). These proposals are intended to achieve common requirements and language between the JAR and FAR requirements and also make some of the requirements more rational, while maintaining at least the level of safety provided by the current requirements.

EQUIVALENT SAFETY FINDING

Delete JAR 25.1522, remove reference to JAR 25.1522 in JAR 25.1583(b)(1), delete in its entirety the current Subpart J, and introduce the revised subpart J as detailed below :

SUBPART J - GAS TURBINE AUXILIARY POWER UNIT INSTALLATIONS

GENERAL

JAR 25J901 Installation

- (a) For the purpose of this subpart, the APU includes:
- (1) Any engine delivering rotating shaft power, compressed air, or both, which is not intended for direct propulsion of an aeroplane.
 - (2) Each component that affects the control of the APU.
 - (3) Each component that affects the safety of the APU and the APU installation.
- (b) For the purpose of this subpart,
- (1) An essential APU is defined as an APU whose function is required for the dispatch of the aeroplane and/or continued safe flight.
 - (2) A non-essential APU is defined as an APU whose function is a matter of convenience, either on the ground or in flight, and may be shut down without jeopardising safe aeroplane operation.
 - (3) operation.
- (c) For each APU:
- (1) The installation must comply with:
 - (i) The installation instructions provided under JAR-APU, and
 - (ii) The applicable provisions of this subpart for non-essential APUs, or
 - (iii) The applicable provisions of this subpart for essential APUs.

- (2) The components of the installation must be constructed, arranged, and installed so as to ensure their continued safe operation between normal inspections or overhauls. (See ACJ 25J901(c)(2).)
 - (3) The installation must be accessible for necessary inspections and maintenance; and
 - (4) The major components of the installation must be electrically bonded to the other parts of the aeroplane. (See ACJ 25J901(c)(4).)
- (d) The APU installation must comply with JAR 25.1309, except that the effects of the following need not comply with JAR 25.1309(b) (see ACJ 25.901(c)):
- (i) APU case burn through or rupture; and
 - (ii) Uncontained APU rotor failure.

JAR 25J903 Auxiliary Power Unit

- (a) Each APU must meet the appropriate requirements of JAR-APU for its intended function:
- (1) Essential: category I APU,
 - (2) Non-essential: category I or category II APU.
- (c) Control of APU rotation and shut-down capability.
- (1) It shall be possible to shut down the APU from the flight deck in normal and emergency conditions.
 - (2) Where continued rotation of an APU could jeopardise the safety of the aeroplane, there must be a means for stopping rotation. Each component of the stopping system located in the APU compartment must be at least fire resistant.
- (d) For APU installation:
- (1) Design precautions must be taken to minimise the hazards to the aeroplane in the event of an APU rotor failure or of a fire originating within the APU which burns through the APU casing. (See AMJ 20-128A.)
 - (2) The APU system must be designed and installed to give reasonable assurance that APU operating limitations that adversely affect turbine rotor structural integrity will not be exceeded in service.
- (e) Inflight start capability.
- (1) For non-essential APUs that can be started in flight and all essential APUs-
 - (i) Means must be provided to start the APU in flight, and
 - (ii) An altitude and airspeed envelope must be established and demonstrated for APU inflight starting.
 - (2) For essential APUs-
Cold soak must be considered in establishing the envelope of JAR 25J903 (e)(1)(ii).

JAR 25J939 APU operating characteristics

- (a) APU operating characteristics must be investigated to determine that no adverse characteristics (such as stall, surge, or flame-out) are present, to a hazardous degree, during normal and emergency operation within the range of operation limitations of the aeroplane and of the APU.
- (c) The APU air inlet system may not, as a result of air-flow distortion during normal operation, cause vibration harmful to the APU.
- (d) It must be established over the range of operating conditions for which certification is required, that the APU installation vibratory conditions do not exceed the critical frequencies and amplitudes established under JAR-APU, section 1, appendix 1, paragraph 6.18.

JAR 25J943 Negative acceleration

No hazardous malfunction of an APU or any component or system associated with the APU may occur when the aeroplane is operated at the negative accelerations within the flight envelopes prescribed in JAR 25.333. This must be shown for the greatest duration expected for the acceleration.

(See ACJ 25J943.)

FUEL SYSTEM

JAR 25J951 General

- (c) Each fuel system must be constructed and arranged to ensure a flow of fuel at a rate and pressure established for proper APU functioning under each likely operating condition, including any manoeuvre for which certification is requested and during which the APU is permitted to be in operation.
- (b) For essential APUs-
Each fuel system must be arranged so that any air which is introduced into the system will not result in flameout.
- (c) For essential APUs-
Each fuel system for an essential APU must be capable of sustained operation throughout its flow and pressure range with fuel initially saturated with water at 80 °F (26.7 °C) and having 0.75 cm³ of free water per gallon (3.79 l) added and cooled to the most critical condition for icing likely to be encountered in operation.

JAR 25J952 Fuel system analysis and test

- (a) Proper fuel system functioning under all probable operating conditions must be shown by analysis and those tests found necessary by the Authority. Tests, if required, must be made using the aeroplane fuel system or a test article that reproduces the operating characteristics of the portion of the fuel system to be tested.
- (b) The likely failure of any heat exchanger using fuel as one of its fluids may not result in a hazardous condition.

JAR 25J953 Fuel system independence

Each fuel system must allow the supply of fuel to the APU-

- (a) Through a system independent of each part of the system supplying fuel to the main engines; or
- (b) From the fuel supply to the main engine if provision is made for a shut-off means to isolate the APU fuel line.

JAR 25J955 Fuel flow

- (a) Each fuel system must provide at least 100 percent of the fuel flow required by the APU under each intended operating condition and manoeuvre. Compliance must be shown as follows:
 - (1) Fuel must be delivered at a pressure within the limits specified for the APU.
 - (2) For essential APUs-
 - (i) The quantity of fuel in the tank may not exceed the amount established as the unusable fuel supply for that tank under the requirements of JAR 25.959 plus that necessary to show compliance with this section.
 - (ii) Each main pump must be used that is necessary for each operating condition and attitude for which compliance with this section is shown, and the appropriate emergency pump must be substituted for each main pump so used.
 - (iii) If there is a fuel flow meter, it must be blocked and the fuel must flow through the meter or its bypass. (See ACJ 25J955(a)(4).)

- (b) For essential APUs-

If an APU can be supplied with fuel from more than one tank, the fuel system must, in addition to having appropriate manual switching capability, be designed to prevent interruption of fuel flow to that APU, without attention by the flight crew, when any tank supplying fuel to that APU is depleted of usable fuel during normal operation, and any other tank, that normally supplies fuel to that APU, contains usable fuel.

JAR 25J961 Fuel system hot weather operation

For essential APUs-

- (a) The fuel supply of an APU must perform satisfactorily in hot weather operation. It must be shown that the fuel system from the tank outlet to the APU is pressurised under all intended operations so as to prevent vapour formation. Alternatively, it must be shown that there is no evidence of vapour lock or other malfunctioning during a climb from the altitude of the airport selected by the applicant to the maximum altitude established as an operating limitation under JAR 25J1527, with the APU operating at the most critical conditions for vapour formation but not exceeding the maximum essential load conditions. If the fuel supply is dependant on the same fuel pumps or fuel supply as the main engines, the main engines must be operated at maximum continuous power.
 - (5) The fuel temperature must be at least 110°F (43°C) at the start of the climb. (See ACJ 25J961(a)(5).)
- (b) The test prescribed in sub-paragraph (a) of this paragraph may be performed in flight or on the ground under closely simulated flight conditions. If a flight test is performed in weather cold enough to interfere with the proper conduct of the test, the fuel tank surfaces, fuel lines, and other fuel system parts subject to cold air must be insulated to simulate, insofar as practicable, flight in hot weather.

JAR 25J977 Fuel tank outlet

For essential APUs-

- (a) There must be a fuel strainer for the fuel tank outlet or for the booster pump. This strainer must prevent the passage of any object that could restrict fuel flow or damage any fuel system component.
- (b) The clear area of each fuel tank outlet strainer must be at least five times the area of the outlet line.
- (c) The diameter of each strainer must be at least that of the fuel tank outlet.
- (d) Each finger strainer must be accessible for inspection and cleaning.

JAR 25J991 Fuel pumps

(See ACJ 25J991)

For essential APUs-

- (a) Main pumps. Each fuel pump required for proper essential APU operation, or required to meet the fuel system requirements of this subpart (other than those in sub-paragraph (b) of this paragraph), is a main pump. For each main pump, provision must be made to allow the bypass of each positive displacement fuel pump other than a fuel pump approved as part of the APU.
- (b) Emergency pumps. There must be emergency pumps or another main pump to feed an essential APU immediately after failure of any main pump (other than a fuel pump approved as part of the APU).

JAR 25J993 Fuel system lines and fittings

- (a) Each fuel line must be installed and supported to prevent excessive vibration and to withstand loads due to fuel pressure and accelerated flight conditions.
- (b) Each fuel line connected to components of the aeroplane between which relative motion could exist must have provisions for flexibility.
- (c) Each flexible connection in fuel lines that may be under pressure and subjected to axial loading must use flexible hose assemblies or equivalent means.

- (d) Flexible hose must be approved or must be shown to be suitable for the particular application.
- (e) No flexible hose that might be adversely affected by exposure to high temperatures may be used where excessive temperatures will exist during operation or after an APU shut-down.
- (f) Each fuel line within the fuselage must be designed and installed to allow a reasonable degree of deformation and stretching without leakage.

JAR 25J994 Fuel system components

Fuel system components in the APU compartment or in the fuselage must be protected from damage which could result in spillage of enough fuel to constitute a fire hazard as a result of a wheels-up landing on a paved runway.

JAR 25J995 Fuel valves

In addition to the requirements of JAR 25J1189 for shut-off means, each fuel valve must be supported so that no loads resulting from their operation or from accelerated flight conditions are transmitted to the lines attached to the valve, unless adequate strength margins under all loading conditions are provided in the lines and connections.

JAR 25J997 Fuel strainer or filter

For essential APUs-

There must be a fuel strainer or filter between the fuel tank outlet and the inlet of either the fuel metering device or an APU driven positive displacement pump, whichever is nearer the fuel tank outlet. This fuel strainer or filter must:

- (a) Be accessible for draining and cleaning and must incorporate a screen or element which is easily removable;
- (b) Have a sediment trap and drain except that it need not have a drain if the strainer or filter is easily removable for drain purposes;
- (c) Be mounted so that its weight is not supported by the connecting lines or by the inlet or outlet connections of the strainer or filter itself, unless adequate strength margins under all loading conditions are provided in the lines and connections; and
- (d) Have the capacity (with respect to operating limitations established for the APU) to ensure that APU fuel system functioning is not impaired, with the fuel contaminated to a degree (with respect to particle size and density) that is greater than that established for the APU in JAR APU, section 1, appendix 1, paragraph 6.6.

OIL SYSTEM

JAR 25J1011 Oil System General

- (a) Each APU must have an independent oil system that can supply it with an appropriate quantity of oil at a temperature not above that safe for continuous operation.
- (b) The usable oil capacity may not be less than the product of the endurance of the aeroplane and the approved maximum allowable oil consumption of the APU plus a suitable margin to ensure system circulation.

JAR 25J1017 Oil lines and fittings

- (a) Each oil line must meet the requirements of JAR 25J993 and each oil line and fitting in any designated fire zone must meet the requirements of JAR 25J1183.
- (b) Breather lines must be arranged so that:
 - (1) Condensed water vapour that might freeze and obstruct the line cannot accumulate at any point;
 - (2) The breather discharge does not constitute a fire hazard;
 - (3) The breather does not discharge into the APU air intake system.

JAR 25J1019 Oil filter

Where there is a filter in the APU lubrication system through which all the oil flows, it must be constructed and installed so that oil may flow at an acceptable rate through the rest of the system with the filter element completely blocked. An impending filter by-pass indication is required.

JAR 25J1021 Oil system drains

A drain (or drains) must be provided to allow safe drainage of the oil system. Each drain must:

- (a) Be accessible; and
- (b) Have manual or automatic means for positive locking in the closed position.

JAR 25J1023 Oil radiators

- (a) Each oil radiator must be able to withstand, without failure, any vibration, inertia, and oil pressure load to which it would be subjected in operation.

JAR 25J1025 Oil valves

- (a) Each oil shut-off must meet the requirements of JAR 25J1189.
- (b) Each oil valve must have positive stops or suitable index provisions in the "on" and "off" positions and must be supported so that no loads resulting from its operation or from accelerated flight conditions are transmitted to the lines attached to the valve, unless adequate strength margins under all loading conditions are provided in the lines and connections.

COOLING

JAR 25J1041 General

The APU cooling provisions must be able to maintain the temperatures of APU components and fluids within the temperature limits established for these components and fluids, under critical ground and flight operating conditions, and after normal APU shutdown. (See ACJ 25J1041.)

JAR 25J1043 Cooling tests

- (a) General. Compliance with JAR 25J1041 must be shown by tests, under critical conditions. For these tests, the following apply:
 - (1) If the tests are conducted under conditions deviating from the maximum ambient atmospheric temperature, the recorded APU temperatures must be corrected under sub-paragraph (c) of this paragraph.
 - (2) No corrected temperatures determined under sub-paragraph (a)(1) of this paragraph may exceed established limits.
- (b) Maximum ambient atmospheric temperature. A maximum ambient atmospheric temperature corresponding to sea level conditions must be established. The temperature lapse rate is 3.6°F (2.0°C) per thousand feet of altitude above sea level until a temperature of -69.7°F (-56.5°C) is reached, above which altitude, the temperature is considered constant at -69.7°F (-56.5°C).
- (c) Correction factor. Unless a more rational correction applies, temperatures of APU fluids and components for which temperature limits are established, must be corrected by adding to them the difference between the maximum ambient atmospheric temperature and the temperature of the ambient air at the time of the first occurrence of the maximum component or fluid temperature recorded during the cooling test.

JAR 25J1045 Cooling test procedures

- (a) Compliance with JAR 25J1041 must be shown for the critical conditions that correspond to the applicable performance requirements. The cooling tests must be conducted with the aeroplane in the configuration, and operating under the conditions that are critical relative to cooling. For the cooling tests, a temperature is 'stabilised' when its rate of change is less than 2°F (1°C) per minute.

- (b) Temperatures must be stabilised prior to entry into each critical condition being investigated, unless the entry condition normally is not one during which component and APU fluid temperatures would stabilise (in which case, operation through the full entry condition must be conducted before entry into the critical condition being investigated in order to allow temperatures to reach their natural levels at the time of entry).
- (c) Cooling tests for each critical condition must be continued until-
 - (1) The component and APU fluid temperatures stabilise;
 - (2) The stage of flight is completed; or
 - (3) An operating limitation is reached.

AIR INTAKE AND BLEED AIR DUCT SYSTEMS

JAR 25J1091 Air intake

The air intake system for the APU:

- (a) Must supply the air required by the APU under each operating condition for which certification is requested,
- (b) May not draw air from within the APU compartment or other compartments unless the inlet is isolated from the APU accessories and power section by a firewall,
- (c) Must have means to prevent hazardous quantities of fuel leakage or overflow from drains, vents, or other components of flammable fluid systems from entering,
- (d) Must be designed to prevent water or slush on the runway, taxiway, or other airport operating surface from being directed into the air intake system in hazardous quantities,
- (e) Must be located or protected so as to minimise the ingestion of foreign matter during take-off, landing, and taxiing.

JAR 25J1093 Air intake system icing protection

- (a) Each non-essential APU air intake system, including any screen if used, which does not comply with JAR 25J1093(b) will be restricted to use in non-icing conditions, unless it can be shown that the APU complete with air intake system, if subjected to icing conditions, will not affect the safe operation of the aeroplane.
- (b) For essential APUs:
Each essential APU air intake system, including screen if used, must enable the APU to operate over the range of conditions for which certification is required without adverse effect or serious loss of power (see ACJ 25J1093(b)(2)):
 - (1) Under the icing conditions specified in Appendix C; and
 - (2) In falling and blowing snow within the limitations established for the aeroplane for such operations.

JAR 25J1103 Air intake system ducts

- (a) Each air intake system duct must be:
 - (1) Drained to prevent accumulation of hazardous quantities of flammable fluid and moisture in the ground attitude. The drain(s) must not discharge in locations that light cause a fire hazard.
 - (2) Constructed of materials that will not absorb or trap sufficient quantities of flammable fluids such as to create a fire hazard,
 - (3) Designed to prevent air intake system failures resulting from reverse flow, APU surging, or inlet door closure,
 - (4) Fireproof within the APU compartment,
 - (5) Flexible if connected to components between which relative motion could exist.
- (b) Each APU air intake system duct must be fireproof for a sufficient distance upstream of the APU compartment to prevent hot gases reverse flow from burning through the APU air intake system ducts and entering any other compartment or area of the aeroplane in which a hazard would be created resulting from the entry of hot gases.

The materials used to form the remainder of the air intake system duct and plenum chamber of the APU must be capable of resisting the maximum heat conditions likely to occur.

JAR 25J1106 Bleed air duct systems

- (a) For APU bleed air duct systems, no hazard may result if a duct failure occurs at any point between the air duct source and the aeroplane unit served by the bleed air.
- (b) Each duct connected to components between which relative motion could exist must have a means for flexibility.
- (c) Where the airflow delivery from the APU and main engine is delivered to a common manifold system, precautions must be taken to minimise the possibility of a hazardous condition due to reverse airflow through the APU resulting from malfunctions of any component in the system.

EXHAUST SYSTEM

JAR 25J1121 General

- (a) Each exhaust system must ensure safe disposal of exhaust gases without fire hazard or carbon monoxide contamination in any personnel compartment. For test purposes, any acceptable carbon monoxide detection method may be used to show the absence of carbon monoxide.
- (b) Each exhaust system part with a surface hot enough to ignite flammable fluids or vapours must be located or shielded so that leakage from any system carrying flammable fluids or vapours will not result in a fire caused by impingement of the fluids or vapours on any part of the exhaust system including shields for the exhaust system.
- (c) Each component that hot exhaust gases could strike, or that could be subjected to high temperatures from exhaust system parts, must be fireproof. All exhaust system components must be separated by fireproof shields from adjacent parts of the aeroplane that are outside the APU compartment.
- (d) No exhaust gases may discharge so as to cause a fire hazard with respect to any flammable fluid vent or drain.
- (f) Each exhaust system component must be ventilated to prevent points of excessively high temperature.
- (g) Each exhaust shroud must be ventilated or insulated to avoid, during normal operation, a temperature high enough to ignite any flammable fluids or vapours external to the shroud.

JAR 25J1123 Exhaust piping

- (a) Exhaust piping must be heat and corrosion resistant, and must have provisions to prevent failure due to expansion by operating temperatures.
- (b) Piping must be supported to withstand any vibration and inertia loads to which it would be subjected in operation; and
- (c) Piping connected to components between which relative motion could exist must have means for flexibility.

APU CONTROLS AND ACCESSORIES

JAR 25J1141 APU controls

- (a) Means must be provided on the flight deck for starting, stopping, and emergency shutdown of each installed APU. Each control must:
 - (1) Be located, arranged, and designed under JAR 25.777(a)(b)(c)(d) and marked under JAR 25.1555(a); and
 - (2) Be located so that it cannot be inadvertently operated by persons entering, leaving, or moving normally on the flight deck; and
 - (3) Be able to maintain any set position without constant attention by flight crew members and without creep due to control loads or vibration; and

- (4) Have sufficient strength and rigidity to withstand operating loads without failure and without excessive deflection; and
 - (5) For flexible controls, be approved or must be shown to be suitable for the particular application.
- (b) APU valve controls located in the flight deck must have-
- (1) For manual valves, positive stops or, in the case of fuel valves, suitable index provisions in the open and closed positions,
 - (2) In the case of valves controlled from the flight deck other than by mechanical means, where the correct functioning of the valve is essential for the safe operation of the aeroplane, a valve position indicator which senses directly that the valve has attained the position selected must be provided, unless other indications in the flight deck give the flight crew a clear indication that the valve has moved to the selected position. A continuous indicator need not be provided.
- (c) For unattended operation, the APU must:
- (1) Provide means to automatically shut down the APU for the following conditions:
 - (i) Exceedance of any APU parameter limit or existence of a detectable hazardous APU operating condition; and
 - (ii) Bleed air duct failure between the APU and aeroplane unit served by the bleed air, unless it can be shown that no hazard exists to the aeroplane.
 - (2) Provide means to automatically shut off flammable fluids per JAR 25J1189 in case of fire in the APU compartment.
- (d) APU controls located elsewhere on the aeroplane, which are in addition to the flight deck controls, must meet the following requirements:
- (1) Each control must be located so that it cannot be inadvertently operated by persons entering, leaving, or moving normally in the area of the control; and
 - (2) Each control must be able to maintain any set position without creep due to control loads, vibration, or other external forces resulting from the location.
- (e) The portion of each APU control located in a designated fire zone that is required to be operated in the event of a fire must be at least fire resistant.

JAR 25J1163 APU accessories

- (a) APU mounted accessories must be approved for installation on the APU concerned and use the provisions of the APU for mounting.
- (b) Electrical equipment subject to arcing or sparking must be installed to minimise the probability of contact with any flammable fluids or vapours that might be present in a free state.
- (c) For essential APUs:
If continued rotation of a failed aeroplane accessory driven by the APU affects the safe operation of the aeroplane, there must be means to prevent rotation without interfering with the continued operation of the APU.

JAR 25J1165 APU ignition systems

Each APU ignition system must be independent of any electrical circuit except those used for assisting, controlling, or analysing the operation of that system.

APU FIRE PROTECTION

JAR 25J1181 Designated fire zone

- (a) Any APU compartment is a designated fire zone.
- (b) Each designated fire zone must meet the requirements of JAR 25J1185 through JAR 25J1203.

JAR 25J1183 Lines, fittings and components

- (a) Except as provided in sub-paragraph (b) of this paragraph, each line, fitting, and other component carrying flammable fluid in any area subject to APU fire conditions, and each

component which conveys or contains flammable fluid in a designated fire zone must be fire resistant, except that flammable fluid tanks and supports in a designated fire zone must be fireproof or be enclosed by a fireproof shield unless damage by fire to any non-fireproof part will not cause leakage or spillage of flammable fluid. Components must be shielded or located to safeguard against the ignition of leaking flammable fluid.

- (b) Sub-paragraph (a) of this paragraph does not apply to:
 - (1) Lines and fittings already approved as part of an APU, and
 - (2) Vent and drain lines, and their fittings, whose failure will not result in, or add to, a fire hazard.
- (c) All components, including ducts, within a designated fire zone which, if damaged by fire could result in fire spreading to other regions of the aeroplane, must be fireproof. Those components within a designated fire zone, which could cause unintentional operation of, or inability to operate essential services or equipment, must be fireproof.

JAR 25J1185 Flammable fluids

- (a) No tank or reservoir that is a part of a system containing flammable fluids or gases may be in a designated fire zone unless the fluid contained, the design of the system, the materials used in the tank, the shut-off means, and all connections, lines, and controls provide a degree of safety equal to that which would exist if the tank or reservoir were outside such a zone.
- (b) There must be at least one-half inch (12,7 mm) of clear airspace between each tank or reservoir and each firewall or shroud isolating a designated fire zone.
- (c) Absorbent materials close to flammable fluid system components that might leak must be covered or treated to prevent the absorption of hazardous quantities of fluids.

JAR 25J1187 Drainage and ventilation of fire zones

- (a) There must be complete drainage of each part of each designated fire zone to minimise the hazards resulting from failure or malfunctioning of any component containing flammable fluids.

The drainage means must be-

 - (1) Effective under conditions expected to prevail when drainage is needed; and
 - (2) Arranged so that no discharged fluid will cause an additional fire hazard.
- (b) Each designated fire zone must be ventilated to prevent the accumulation of flammable vapours.
- (c) No ventilation opening may be where it would allow the entry of flammable fluids, vapours, or flame from other zones.
- (d) Each ventilation means must be arranged so that no discharged vapours will cause an additional fire hazard.
- (e) Unless the extinguishing agent capacity and rate of discharge are based on maximum air flow through a zone, there must be means to allow the crew to shut off sources of forced ventilation to any fire zone.

JAR 25J1189 Shut-off means

- (a) Each APU compartment specified in JAR 25J1181(a) must have a means to shut-off or otherwise prevent hazardous quantities of flammable fluids, from flowing into, within, or through any designated fire zone, except that shut-off means are not required for:
 - (1) Lines, fittings and components forming an integral part of an APU; and
 - (2) Oil systems for APU installations in which all external components of the oil system, including the oil tanks, are fireproof.
- (b) The closing of any fuel shut-off valve for any APU may not make fuel unavailable to the main engines.
- (c) Operation of any shut-off may not interfere with the later emergency operation of other equipment.

- (d) Each flammable fluid shut-off means and control must be fireproof or must be located and protected so that any fire in a fire zone will not affect its operation.
- (e) No hazardous quantity of flammable fluid may drain into any designated fire zone after shut-off.
- (f) There must be means to guard against inadvertent operation of the shut-off means and to make it possible for the crew to reopen the shut-off means in flight after it has been closed.
- (g) Each tank to APU shut-off valve must be located so that the operation of the valve will not be affected by the APU mount structural failure.
- (h) Each shut-off valve must have a means to relieve excessive pressure accumulation unless a means for pressure relief is otherwise provided in the system.

JAR 25J1191 Firewalls

- (a) Each APU must be isolated from the rest of the aeroplane by firewalls, shrouds, or equivalent means.
- (b) Each firewall and shroud must be:
 - (1) Fireproof;
 - (2) Constructed so that no hazardous quantity of air, fluid, or flame can pass from the compartment to other parts of the aeroplane;
 - (3) Constructed so that each opening is sealed with close fitting fireproof grommets, bushings, or firewall fittings; and
 - (4) Protected against corrosion.

JAR 25J1193 APU compartment

- (a) Each compartment must be constructed and supported so that it can resist any vibration, inertia, and air load to which it may be subjected in operation.
- (b) Each compartment must meet the drainage and ventilation requirements of JAR 25J1187.
- (d) Each part of the compartment subject to high temperatures due to its nearness to exhaust system parts or exhaust gas impingement must be fireproof.
- (e) Each aeroplane must-
 - (1) Be designed and constructed so that no fire originating in any APU fire zone can enter, either through openings or by burning through external skin, any other zone or region where it would create additional hazards,
 - (2) Meet sub-paragraph (e)(1) of this paragraph with the landing gear retracted (if applicable), and
 - (3) Have fireproof skin in areas subject to flame if a fire starts in the APU compartment.

JAR 25J1195 Fire extinguisher systems

- (a) There must be a fire extinguisher system serving the APU compartment.
- (b) The fire extinguishing system, the quantity of the extinguishing agent, the rate of discharge, and the discharge distribution must be adequate to extinguish fires. An individual 'one shot' system is acceptable. (See ACJ 25J1195(b).)
- (c) The fire-extinguishing system for an APU compartment must be able to simultaneously protect each zone of the APU compartment for which protection is provided.

JAR 25J1197 Fire extinguishing agents

- (a) Fire extinguishing agents must-
 - (1) Be capable of extinguishing flames emanating from any burning of fluids or other combustible materials in the area protected by the fire extinguishing system; and
 - (2) Have thermal stability over the temperature range likely to be experienced in the compartment in which they are stored.
- (b) If any toxic extinguishing agent is used, provisions must be made to prevent harmful concentrations of fluid or fluid vapours (from leakage during normal operation of the aeroplane or as a result of discharging the fire extinguisher on the ground or in flight) from

entering any personnel compartment, even though a defect may exist in the extinguishing system.

JAR 25J1199 Extinguishing agent containers

- (a) Each extinguishing agent container must have a pressure relief to prevent bursting of the container by excessive internal pressures.
- (b) The discharge end of each discharge line from a pressure relief connection must be located so that discharge of the fire extinguishing agent would not damage the aeroplane. The line must be located or protected to prevent clogging caused by ice or other foreign matter.
- (c) There must be a means for each fire extinguishing agent container to indicate that the container has discharged or that the charging pressure is below the established minimum necessary for proper functioning.
- (d) The temperature of each container must be maintained, under intended operating conditions, to prevent the pressure in the container from:
 - (1) Falling below that necessary to provide an adequate rate of discharge; or
 - (2) Rising high enough to cause premature discharge.
- (e) If a pyrotechnic capsule is used to discharge the extinguishing agent, each container must be installed so that temperature conditions will not cause hazardous deterioration of the pyrotechnic capsule.

JAR 25J1201 Fire extinguishing system materials

- (a) No material in any fire extinguishing system may react chemically with any extinguishing agent so as to create a hazard.
- (b) Each system component in an APU compartment must be fireproof.

JAR 25J1203 Fire-detector system

- (a) There must be approved, quick acting fire or overheat detectors in each APU compartment in numbers and locations ensuring prompt detection of fire.
- (b) Each fire detector system must be constructed and installed so that:
 - (1) It will withstand the vibration, inertia, and other loads to which it may be subjected in operation;
 - (2) There is a means to warn the crew in the event that the sensor or associated wiring within a designated fire zone is severed at one point, unless the system continues to function as a satisfactory detection system after the severing; and
 - (3) There is a means to warn the crew in the event of a short circuit in the sensor or associated wiring within a designated fire zone, unless the system continues to function as a satisfactory detection system after the short circuit.
- (c) No fire or overheat detector may be affected by any oil, water, other fluids, or fumes that might be present.
- (d) There must be means to allow the crew to check, in flight, the functioning of each fire or overheat detector electric circuit.
- (e) Wiring and other components of each fire or overheat detector system in a fire zone must be at least fire-resistant.
- (f) No fire or overheat detector system component for any fire zone may pass through another fire zone, unless:
 - (1) It is protected against the possibility of false warnings resulting from fires in zones through which it passes; or
 - (2) Each zone involved is simultaneously protected by the same detector and extinguishing system.
- (g) Each fire detector system must be constructed so that when it is in the configuration for installation it will not exceed the alarm activation time approved for the detectors using the response time criteria specified in the appropriate JTSSO or an acceptable equivalent, for the detector.

JAR 25J1207 Compliance

Unless otherwise specified, compliance with the requirements of JAR 25J1181 through JAR 25J1203 must be shown by a full scale test or by one or more of the following methods:

- (a) Tests of similar APU installations.
- (b) Tests of components.
- (c) Service experience of aircraft with similar APU installations.
- (d) Analysis unless tests are specifically required.

GENERAL**JAR 25J1305 APU instruments**

- (a) The following instruments are required for all installation:
 - (1) A fire warning indicator.
 - (2) An indication than an APU auto-shutdown has occurred.
 - (3) Any other instrumentation necessary to assist the flight crew in:
 - (i) Preventing the exceedance of established APU limits, and
 - (ii) Maintaining continued safe operation of the APU.
 - (4) Instrumentation per subparagraph (3) need not be provided if automatic features of the APU and its installation provide a degree of safety equal to having the parameter displayed directly.
- (b) For essential APUs:

In addition to the items required by JAR 25J1305(a), the following indicators are required for an essential APU installation :

 - (1) An indicator to indicate the functioning of the ice protection system, if such a system is installed; and
 - (2) An indicator to indicate the proper functioning of any heater used to prevent ice clogging of fuel system components.

JAR 25J1337 APU instruments

- (c) There must be a stick gauge or equivalent means to indicate the quantity of oil in each tank.

OPERATING LIMITATIONS**JAR 25J1501 General**

- (c) The operating limitations and other information necessary for safe operation must be made available to the crew members as prescribed in JAR 25J1549, 25J1551, and 25J1583.

JAR 25J1521 APU limitations

The APU limitations must be established so that they do not exceed the corresponding proved limits for the APU and its systems. The APU limitations, including categories of operation, must be specified as operating limitations for the aeroplane.

JAR 25J1527 Ambient air temperature and operating altitude

The extremes of the ambient air temperature and operating altitude for which operation is allowed, as limited by flight, structural, APU installation, functional, or equipment characteristics, must be established.

MARKINGS AND PLACARDS**JAR 25J1549 APU instruments**

For each APU instrument either a placard or colour markings or an acceptable combination must be provided to convey information on the maximum and (where applicable) minimum operating limits.

Colour coding must comply with the following:

- (a) Each maximum and, if applicable, minimum safe operating limit must be marked with a red radial or a red line;

- (b) Each normal operating range must be marked with a green arc or green line, not extending beyond the maximum and minimum safe limits;
- (c) Each precautionary operating range must be marked with a yellow arc or a yellow line; and
- (d) Each APU speed range that is restricted because of excessive vibration stresses must be marked with red arcs or red lines.

JAR 25J1551 Oil quantity indicator

Each oil quantity indicator must be marked with enough increments to indicate readily and accurately the quantity of oil.

JAR 25J1557 Miscellaneous markings and placards

- (b) APU fluid filler openings
 - (2) Oil filler openings must be marked at or near the filler cover with the word "oil".

AEROPLANE FLIGHT MANUAL**JAR 25J1583 Operating limitations**

APU limitations established under JAR 25J1521 and information to explain the instrument markings provided under JAR 25J1549 and JAR 25J1551 must be furnished.

INTERPRETATIVE MATERIAL

Delete the ACJ corresponding to subpart J in (ACJ 25A901(b)(2) to ACJ 25A1195(b)) in section 2 of JAR-25, and create ACJ 25J901(c)(2), ACJ 25J901(c)(4), ACJ 25J943, ACJ 25J955(a)(4), ACJ 25J961(a)(5), ACJ 25J991, ACJ 25J1041, ACJ 25J1093(b)(2) and ACJ 25J1195(b) :

ACJ 25J901(c)(2)

Assembly of Components (Auxiliary Power Units) (Interpretative Material)

See JAR 25J901(c)(2)

The objectives of JAR 25.671(b) should be satisfied with respect to APU systems, where the safety of the aeroplane could otherwise be jeopardised.

ACJ 25J901(c)(4)

Electrical Bonding (Auxiliary Power Units) (Interpretative Material)

See JAR 25J901(c)(4)

Where the APU is not in direct electrical contact with its mounting the engine should be electrically connected to the main earth system by at least two removable primary conductors, one on each side of the APU.

ACJ 25J943

APU Operating Characteristics (Auxiliary Power Units) (Interpretative Material)

See JAR 25J943

- (1) Compliance with JAR 25J943 should be shown by design analysis and flight tests. The flight tests should include manoeuvre in which less than zero 'g' occurs for one continuous period of at least 5 seconds and a further manoeuvre with two periods of less than zero 'g' with a total time for these two periods of at least 5 seconds.
- (2) In the case of non-essential APUs, inadvertent shut-down due to negative accelerations is acceptable.

ACJ 25J955(a)(4)

Fuel Flow (Interpretative Material)

See JAR 25J955(a)(4)

The word "blocked" should be interpreted to mean "with the moving parts fixed in the position for maximum pressure drop".

ACJ 25J961(a)(5)

Fuel System Hot Weather Operation (Auxiliary Power Units) (Acceptable Means of Compliance)

See JAR 25J961(a)(5)

Subject to agreement with the Authority, fuel with a higher vapour pressure may be used at a correspondingly lower fuel temperature provided the test conditions closely simulate flight conditions corresponding to an initial fuel temperature of 110°F (43.3°C) at sea-level.

ACJ 25J991

Fuel Pumps (Auxiliary Power Units) (Interpretative Material)

See JAR 25J991

If the fuel supply to the APU is taken from the fuel supply to the main engine, no separate pumps need be provided for the APU.

ACJ 25J1041

General (Auxiliary Power Units) (Interpretative Material)

See JAR 25J1041

The need for additional tests, if any, in hot climatic conditions should take account of any tests made by the APU constructor to establish APU performance and functioning characteristics and of satisfactory operating experience of similar power units installed in other types of aeroplane.

The applicant should declare the maximum climatic conditions for which compliance will be established and this should not be less severe than the ICAO Intercontinental Maximum Standard Climate (100°F (37.8°C) at sea-level). If the tests are conducted under conditions which deviate from the maximum declared ambient temperature, the maximum temperature deviation should not normally exceed 25°F (13.88°C).

ACJ 25J1093(b)(2)

Essential APU Air Intakes (Auxiliary Power Units) (Acceptable Means of Compliance and Interpretative Material)

See JAR 25J1093(b)(2)

- (1) *General.* Two ways of showing compliance with JAR 25J1093(b)(2) are given.
 - 1.1 *Method 1.* Method 1 is an arbitrary empirical method based on United Kingdom and French practice. This method is acceptable to all participating countries.
 - 1.2 *Method 2.* Method 2 is a general approach based on US practice in applying FAR Part 25, Appendix C. If this method is used, each application will have to be evaluated on its merits.
- (2) *Method 1 (Acceptable Means of Compliance)*
 - 2.1 In establishing compliance with the requirements of JAR 25J1093(b)(2), reference should be made to ACJ 25.1419, paragraph 1.
 - 2.2 The intake may be tested with the APU in accordance with the requirements of JAR-APU, Section 1, paragraph 5.2 and the Advisory Material for the testing of APUs in Icing Conditions.
 - 2.3 When the intake is assessed separately it should be shown that the effects of intake icing would not invalidate the icing tests of JAR-APU. Factors to be considered in such evaluation are:
 - a. Distortion of the airflow and partial blockage of the intake.
 - b. The shedding into the APU of intake ice of a size greater than the APU is known to be able to ingest.
 - c. The icing of any APU sensing devices, other subsidiary intakes or equipment contained within the intake.
 - d. The time required to bring the protective system into full operation.
 - 2.4 Tests in Ice-forming Conditions. An acceptable method of showing compliance with the requirements of JAR 25J1093(b)(2), including Appendix C, is given in this paragraph.
 - 2.4.1 When the tests are conducted in non-altitude conditions, the system power supply and the external aero-dynamic and atmospheric conditions should be so modified as to represent the required altitude conditions as closely as possible. The altitudes to be represented should be as indicated in Table 1 for simulated tests, or that appropriate to the desired temperature in flight tests, except that the test altitude need not exceed any limitations proposed for approval. The appropriate intake incidences or the most critical incidence should be simulated.
 - 2.4.2 Two tests (which may be separated or combined) should be conducted at each temperature condition of Table 1, at or near the indicated altitude -
 - a. 30 minutes in the conditions of Table 1 column (a) appropriate to the temperature.
 - b. Three repetitions of 5 km in the conditions of Table 1, column (b), appropriate to the temperature followed by 5 km in clear air.

TABLE 1

Ambient air temperature	Altitude		Liquid water content (g/m ³)		Mean effective droplet diameter (µm)
	(ft)	(m)	(a)	(b)	
-10	17 000	5200	0.6	2.2	20
-20	20 000	6100	0.3	1.7	
-30	25 000	7600	0.2	1.0	

2.4.3 At the conclusion of each of the tests of 2.4.2 the ice accretion should be such as not to adversely affect the subsequent running and functioning of the APU.

2.4.4 If the APU intake contains features or devices which could be affected by freezing fog conditions then in addition to the above tests of 2.4.2 a separate test on these parts or devices should be conducted for a duration of 30 minutes with the heat supply to the tested parts as would be available with the APU set to the minimum ground idle conditions approved for use in icing in an atmosphere of -2°C and a liquid water concentration of 0.3 g/m³. The mean effective droplet size for the test should be 20µm. At the end of the period the ice accretion on the tested part should not prevent its proper functioning nor should the ice be of such size as to hazard the APU if shed.

(3) Method 2 (Interpretative Material)

3.1 In establishing compliance with the requirements of JAR 25J1093(b)(2), reference should be made to JAR 25.1419 and ACJ 25.1419.

3.2 The intake may be tested with the APU in accordance with a programme of tests which results from an analysis of the icing conditions and the APU conditions appropriate to the installation.

3.3 When the intake is assessed separately it should be shown that the effects of intake icing would not invalidate any APU certification tests. Factors to be considered in such evaluation are:

- a. Distortion of the airflow and partial blockage of the intake.
- b. The shedding into the APU of intake ice of a size greater than the APU is known to be able to ingest.
- c. The icing of any APU sensing devices, other subsidiary intakes or equipment contained within the intake.
- d. The time required to bring the protective system into full operation.

3.4 When tests are conducted in non-altitude conditions, the system power supply and the external aerodynamic and atmospheric conditions should be so modified as to represent the altitude condition as closely as possible. The appropriate intake incidences or the most critical incidence, should be simulated.

3.5 Following the analysis required in JAR 25.1419(b), which will determine the critical icing conditions within the envelope of icing conditions defined by Appendix C Figures 1 to 3 and Appendix C Figures 4 to 6, tests should be conducted at such conditions as are required to demonstrate the adequacy of the design points.

3.6 At the conclusion of each of the tests the ice accretion should be such as not to adversely affect the subsequent running and functioning of the APU.

3.7 If the APU intake contains features or devices which could be affected by freezing fog conditions then a separate assessment for these parts should be conducted assuming a duration of 30 minutes and an atmosphere of -2°C and a liquid water concentration of 0.3 g/m³, with the heat supply to the part as would be available with the APU set to the minimum ground idle conditions approved for use in icing. The mean effective droplet size should be 20µm. At the end of the period the ice accretion on the part should not prevent its proper functioning, nor should the ice be of such size as to hazard the engine if shed.

ACJ 25J1195(b)

Fire Extinguisher Systems (Auxiliary Power Units) (Interpretative Material and Acceptable Means of Compliance)

See JAR 25J1195(b)

Acceptable methods to establish the adequacy of the fire extinguisher system are laid down in Advisory Circular 20 - 100.

– END –

EQUIVALENT SAFETY FINDING	K-06 ESF: Localizer Excessive Deviation Alerts
APPLICABILITY:	A380
REQUIREMENTS:	JAR-AWO 236, AWO 321 (a)(5)
ADVISORY MATERIAL:	N/A

BACKGROUND

Airbus proposes to design the A380 so that the localizer excessive deviation alerts are inhibited below 15 feet.

The applicable requirements state that the excessive deviation alerts must be active at least from 90 m (300 feet) to the Decision Height (DH) but that the glide path alert should not be active below 30 feet" (JAR-AWO 236(c), at Change 2) As a direct consequence, this means that the localizer excessive deviation alert must be active until DH Airbus intends to apply for certification of the A380 Auto land system capability down to no Decision Height. With the interpretation that No DH is equivalent to DH=0, this would imply that the A380 design does not meet JAR-A WO 236(c), at Change 2.

CONCLUSION

Airbus requested an Equivalent Safety Finding for JAR-AWO 236 / JAR-AWO 321(a)(5), based on the following argumentation:

1- Regulatory Background

Airbus would like to point out that; on this subject the JAR-AWO regulation as currently written is open to interpretation. There is nowhere a requirement that the LOC excessive deviation alert must be available down to the ground:

- JAR-AWO regulation states that LOC excessive deviation alerts must be provided down to the Decision Height
- Operations with a Decision Height rue based on a requirement for visual contact with the runway prior to touchdown and it is not practical to set the DH to less than 15 feet.
- "No DH" operations cannot be assimilated to operations with a Decision Height set to 0, since it is a different concept not based on a Decision Height but on an Alert Height required to be set to 100 feet as a minimum.

Airbus position is therefore that the inhibition of the LOC excessive deviation alert below 15 feet should not be presented as a deviation to the A380 EASA certification basis.

It may be worth recalling also that the ILS excessive deviation alert is not required by FAA regulations, whose operational concept for CAT IIIB is historically associated to No DH.

2- Operational Argumentation

The projected A380 design is not driven by cost nor implementation constraints Airbus main arguments come from in-house operational expertise.

Below 15 feet, the conservative scenario to be considered is an automatic landing in No DH operation: the failures affecting aircraft trajectory can be detected, and pilot can take over.

The safety impact of pilot take-over has been assessed on a simulator during all past certification demonstrations and has never been classified worse than Major.

More recently, before fixing A340-600 definition Airbus performed a specific evaluation with simulated LOC excessive deviation below 15 feet that highlighted no safety benefits in performing a go-around. Go-around at low altitude was followed in most cases by a runway/ground contact, where lateral guidance is not always targeted the runway axis.

Airbus position is therefore that allowing the crew to take over and complete the landing manually is at least as safe as an automatic go-around from very low altitude.

3- Technical Argumentation

The threshold of the LOC excessive deviation alert on A380 will be set to a tighter value than the +/- 25 mA required by JAR-AWO. The threshold will be set to +/- 20 mA at maximum, as per current Airbus programs, or a lesser value depending on assessment of A380 specificities, such as larger landing gear track, higher inertia. From preliminary computations, based on a threshold value of +/- 18 mA, and under conservative hypothesis on the runway length and touch down distance, this would result in activating the alert at 15 feet when the aircraft deviates more than +/- 12 meters from the runway axis, instead of +/- 15 meters as per JAR-AWO settings.

This tighter alert setting was used to justify an Equivalent Safety Finding on A340-500/-600 and A318 programs where this issue was first raised.

4- In-Service Experience

The inhibition of the LOC excessive deviations alert below 15 feet is a basic Air bus design certified on all WB, SA and LR aircrafts, and is therefore supported by a large in service experience. The only in-service event related to this design happened on a WB aircraft in Kushiro where an incorrectly set ILS course induced a de-stabilised approach condition. The subject is traced in an ARS, and there is no evidence that for this incident having the LOC excessive deviation alert down to the ground would have improved the situation. It only confirmed the adequate setting of the LOC excessive deviation on Airbus WB aircraft.

This was accepted in the DGAC letter ref SFACT/NAT/2003/4110 where it was acknowledged that the current design is not unsafe.

After review of the above argumentation, the EASA teams considers that the Airbus A380 design for Localiser Excess Deviation Alerts, whilst not strictly complying with JAR-AWO 236 / JAR-AWO 321(a)(5), may be shown to meet the intent of the rule and to present an equivalent safety level.

This equivalent safety level is based on:

- Airbus technical analysis of relevant failure cases
- The LOC Excessive Deviation threshold setting more severe than the standard required by JAR AWO (i.e., 25 mA)
- The A380 design is more robust than that seen on Airbus A310 / A300-600 family. The implementation of de-crab law and the prevention to manually change the ILS course under 700 feet are considered as improvements over the earlier A310 / A300-600 design
- The justification that continuing the landing will be safe under the realistic scenarios associated with LOC deviations of greater than 18 mA at or below 15 feet and that a go-around may safely be performed from any point on the approach to touchdown.

– END –

EQUIVALENT SAFETY FINDING and IM	K-07 ESF: Limit Risk (NPA AWO 14)
APPLICABILITY:	A380
REQUIREMENTS:	JAR-AWO 131(c)(4), JAR-AWO 131(c)(6)
ADVISORY MATERIAL:	ACJ AWO 131 1.4

BACKGROUND

A380 applicable Type Certification Basis is JAR 25 at change 15 and JAR AWO at change 2.

Airbus has requested to elect to comply to NPA AWO-14.

This NPA addresses the following JAA/FAA AWO harmonisation items:

- Loads for Landing Performance (proposal n°1, ref. AHI 35)
- Lateral Touchdown Performance Limits (proposal n°2, ref. AHI 38).

The proposal n°1 revises the JAR-AWO requirement so that it refers to limit load only, without reference to rate of descent or sideslip. The ACJ is revised to specify 10 fps as the acceptable arbitrary sink rate value at Touch down, unless the manufacturer has used a higher value in complying with Part 25.

The proposal n°1 also accounts for certification experience that has shown that the Limit Risk demonstration in conjunction with the revised Structural Limit Load definition and today's Wind Model is too severe. The proposal n°1 enables to factor the Wind limit risk probabilities by the probability of wind.

The FAA has no requirement for limit risk demonstration.

The proposal n°2 is harmonising the JAR AWO and FAA AC120-28D acceptable probability on the average risk of a wing tip touching the ground before the wheels.

SPECIAL CONDITION

1. Revise JAR-AWO 131(c)(4) to read: "(4) Structural Limit Load."
2. Delete JAR-AWO 131(c)(6).

INTERPRETATIVE MATERIAL

1. Revise ACJ AWO 131 1.4 d. to read:

" d. Structural Limit Load. 10-6 10-5

See paragraph 1.4.1."

2. Delete ACJ AWO 131 1.4 f.

3. In ACJ AWO 131 1.4 ,revise the NOTE below the table as follows:

NOTE:

1. The 'Average' column is the acceptable probability of exceedance where all the variables vary according to their probability distributions. The 'Limit' column is the acceptable probability of exceedance if one variable is held at its most adverse value, while the other variables vary according to their probability distributions. In the case where a wind variable is held at its most adverse value, the acceptable probability of exceedance should be taken as the average column factored by the cumulative probability of reported wind as defined in FIGURE 1 of ACJ AWO 131 paragraph 3.1.1.

4. Add a new paragraph 1.4.1 to ACJ AWO 131 as follows:

1.4.1 An acceptable means of establishing that the structural limit load is not exceeded is to show separately and independently that:

- i) The sink rate at touchdown does not exceed the limit rate of descent used for certification under JAR Part 25 Subpart C, or 10 feet per second, whichever is the greater, and,
- ii) The lateral side load does not exceed the limit value determined for the lateral drift landing condition defined in JAR 25.479(d)(2).

5. Revise ACJ AWO 131, 1.4 e as follows:

"Bank angle such that a wing tip, engine nacelle or propeller 10-7 10-6 touch the ground before the wheels"

– END –

ACRONYMS AND ABBREVIATIONS

ADS	Automatic Dependent Surveillance
AC	Advisory Circular
ACJ	Advisory Circular Joint
AFM	Airplane Flight Manual
AMC	Acceptable Means of Compliance
AMJ	Advisory Material Joint
AMM	Aircraft Maintenance Manual
AOA	Angle Of Attack
APU	Auxiliary Power Unit
ARAC	Aviation Rulemaking Advisory Committee
ASPSU	Auxiliary Standby Power Supply Unit
ATN	Air Traffic Network
ATS	Air Traffic Service
AVM	Airborne Vibration Monitor
AWO	All Weathers Operations
CC	Cargo Compartment
CCRC	Cabin Crew Rest Compartments
CFD	Computational Fluid Dynamics
CLS	Cargo Loading System
CLTA	Conventional Large Transport Aircraft
CMR	Certification Maintenance Requirements
CFR	Code of Federal Regulations
CFRP	Carbon Fiber Reinforced Plastic
CPDLC	Controller-Pilot Data Link Communications
CRC	Crew Rest Compartments
CRI	Certification Review Item
CRT	Cathode Ray Tube
CVR	Cockpit Voice Recorder
DEV	Deviation
DFZ	Designated Fire Zones
D-FIS	Data Link Flight Information Services
DOP	Delegation Of Power
DOT	Department of Transportation
DH	Decision Height
DRI	Dynamic Response Index
DSG	Design Service Goal
EAS	Equivalent Airspeed
ECAM	Electronic Centralized Aircraft Monitoring
EEC	Engine Electronic Control
EFCS	Electrical Flight Control System
ELOS	Equivalent Level of Safety
EPF	Emergency Passage Feature
EPS	Executive Power System
EPSUs	Emergency Power Supply Units
ESF	Equivalent Safety Finding

ETSO	European Technical Standard Order
FCRC	Flight Crew Rest Compartments
FDR	Flight Data Recorder
FMJ RN	Full Metal Jacket, Round Nose
FQIS	Fuel Quantity Indicating Systems
FWS	Flight Warning System
GFI	Ground Fault Interruption
GVT	Ground Vibration Test
HIC	Head Injury Criterion
HIRF	High Intensity Radiated Fields
HP	High Pressure
HWG	Harmonisation Working Group
ICA	Instructions for Continued Airworthiness
ICAO	International Civil Aviation Organisation
ID	Inside Diameter
IDF	Imbalance Design Fraction
IFE	In-Flight Entertainment
IFSD	In Flight Shut Down
ILD	Inertia Locking Device
IM	Interpretative Material
IMC	Instrument Meteorological Conditions
IP	Intermediate Pressure
ISPSS	In-Seat Power Supply System
JHP	Jacketed Hollow Point
JTSO	Join Technical Service Order
LCD	Liquid Crystal Display
LDCC	Lower Deck Cargo Compartment
LRS	Limit of Reasonable Survivability
LP	Low Pressure
MMEL	Master Minimum Equipment List
MOC	Means Of Compliance
NPA	Notice of Proposal Amendment
NPRM	Notice of Proposed Rulemaking
NTSB	National Transportation Safety Board
OSD	Operational Suitability Data
PBE	Protective Breathing Equipment
PDU	Power Drive Unit
PED	Portable Electronic Device
PPHWG	Power Plant Harmonisation Working Group
RMS	Root Mean Square
RR	Rolls Royce
RTCA	Radio Technical Commission for Aeronautics
RVR	Runway Visual Range
SC	Special Condition
TAS	True Airspeed
TCDS	Type Certificate Data Sheet
TSO	Technical Service Order
TT&L	Taxi, Tack off and Landing

TWA Trans World Airline
VLTA Very Large Transport Aeroplane

-- END --